

LUCID

Lucid Air Sapphire  
Owner's Manual  
North America

*Sapphire*



# Table of Contents

Chapters	Sections	
<b>Introduction</b>	<b>A Message From Lucid</b>	<b>2</b>
	<b>About This Manual</b>	<b>3</b>
	Using This Manual, Locating and Referencing Information	3
	Document Applicability	3
	Symbols Glossary for Important Information	3
	What's New	3
	Illustrations	3
	Revisions and Modifications	4
	Trademarks	4
	Copyright	4
	<b>Information About This Vehicle</b>	<b>5</b>
	Quality Control	5
	Vehicle Modifications	5
	Body Repairs	5
	Electric Vehicle Precautions	5
	Personal Information and Data Sharing	6
	Data Sharing Permissions	6
<hr/>		
<b>Vehicle Overview</b>	<b>Exterior</b>	<b>8</b>
	Exterior Overview	8
	<b>Interior</b>	<b>10</b>
	Interior Overview	10
	Vehicle Identification	12
	Steering Wheel Controls	13
	Glass Cockpit	14
	Pilot Panel	15
	Smart Drawer	15
	Rear Display	16
	<hr/>	
<b>Opening &amp; Closing</b>	<b>Keyless Entry System</b>	<b>18</b>
	Using the Mobile Key	18
	Using the Key Fob	18
	Using the Lucid Key Card	20
	Replacing the Key Fob Battery	20
	PIN to Drive	21
	Caring for the Key Fob	21

Replacement Key Fobs	21
Type Approval	21
<b>Doors</b>	<b>23</b>
Opening Doors from the Outside	23
Opening Doors from the Inside	23
Door Warnings	24
Locking and Unlocking from Inside the Vehicle	24
Child Safety Locks	24
Automatic Locking and Unlocking	24
Opening Interior Doors with No Power	24
<b>Windows</b>	<b>26</b>
Window Safety	26
Opening and Closing Windows	26
Sunshades	27
<b>Hood</b>	<b>28</b>
Hood Opening and Closing	28
Accessing the Front Cargo Area	29
Hood Interior Emergency Release	30
<b>Trunk</b>	<b>31</b>
Trunk Opening and Closing	31
Accessing the Rear Cargo Area	32
Trunk Interior Emergency Release	32
<b>Safety and Security</b>	<b>33</b>
Tow and Break-In Alert	33

---

## Seating & Safety Restraints

<b>Front Seats</b>	<b>35</b>
Adjusting the Front Seats	35
Correct Seating Position	35
Easy Entry & Exit	36
Massage Feature	37
Seat Heating and Ventilation	37
<b>Rear Seats</b>	<b>39</b>
Rear Seat Folding	39
Rear Seat Pass-Through	39
Rear Seat Heaters	40
<b>Head Restraints</b>	<b>41</b>
Correct Head Restraint Position	41
Adjusting the Head Restraints	41
<b>Seat Belts</b>	<b>43</b>
Seat Belt Warnings	43
Wearing Seat Belts	44

Fastening the Seat Belt	44
Seat Belt Reminders	45
Using Seat Belts When Pregnant	45
Seat Belt Pre-Tensioners	46
Location of Seatbelt Pre-Tensioners	47
Testing Seat Belts	48
<b>Child Safety</b>	<b>49</b>
Guidelines for Seating Children	49
Child Safety Seat Warnings	49
Choosing a Child Safety Seat	51
Seating Larger Children	53
Installing Child Safety Seats	53
Installing LATCH or ISOFIX Child Seats	53
Installing Seat Belt-Retained Child Seats	55
Attaching Upper Tether Straps	55
<b>Airbags</b>	<b>57</b>
SRS Airbag System Components	57
Airbag Safety Information	59
Airbag Safety Labels	59
How the Airbags Work	59
Types of Airbags	59
Obstruction of Airbags	61
Front Passenger Seat Occupant Classification System (OCS)	62
Front Passenger Seat OCS Status Indicator	63
Front Passenger Seat OCS Precautions	64
Effects of Airbag Inflation	64
Airbag SRS Warning Indicator	65
Airbag Service Information	65

---

## Driving & Operating

<b>Driver Information</b>	<b>67</b>
Vehicle Information and Alerts	67
Trip Information	67
<b>Pilot Panel</b>	<b>68</b>
Retracting, Extending, or Turning Off the Pilot Panel	68
<b>Center Cockpit Panel</b>	<b>69</b>
Center Cockpit Panel - Overview	69
Warning Indicators	70
High-Voltage Drive System Failure	71
Charge and Power Meter	72
Battery State of Charge Indicator	72
<b>Starting and Powering Off</b>	<b>73</b>

Starting	73
Powering Off	74
<b>Steering Wheel</b>	<b>75</b>
Adjusting the Steering Wheel Position	75
Steering Feel and Sensitivity	75
Steering Wheel - Right Controls	76
Horn	77
<b>Drive Selector</b>	<b>78</b>
Using the Drive Selector	78
Vehicle Creep	78
<b>Drive Modes</b>	<b>80</b>
Drive Modes	80
Launch Mode	81
Limited Power Mode	82
<b>Mirrors</b>	<b>83</b>
Adjusting the Exterior Side Mirror Position	83
Interior Rear View Mirror	83
<b>Exterior Lights</b>	<b>84</b>
Exterior Lights Control	84
High Beam Headlights	85
Rear Fog Light	85
Turn Signals	85
Hazard Warning Lights	86
<b>Interior Lights</b>	<b>87</b>
Interior Lights	87
Ambient Lighting	87
<b>Wipers and Washers</b>	<b>88</b>
Wipers	88
Washers	88
<b>Brakes</b>	<b>90</b>
Braking Systems	90
Anti-Lock Braking System (ABS)	90
Regenerative Braking	91
Vehicle Hold	92
Parking Brake	92
Brake Pad Wear	93
Carbon Ceramic Brakes	94
<b>Lucid Stability Control</b>	<b>96</b>
Lucid Stability Control	96
<b>Getting Maximum Range</b>	<b>97</b>

Driving Tips to Maximize Range	97
<b>Heating, Ventilation Air Conditioning</b>	<b>98</b>
Temperature Control	98
Defrost	99
Max Cool	99
<b>Interior Equipment</b>	<b>101</b>
Sun Visors	101
Glove Box	101
Front Armrest and Storage Compartment	102
Center Console Storage Compartment	102
Rear Armrest and Storage Compartment	102
Cup Holders	102
<b>Accessory Connections</b>	<b>104</b>
USB Connections	104
Wireless Charging	104
12-Volt Power Socket	105

---

## DreamDrive

<b>About DreamDrive</b>	<b>108</b>
DreamDrive Features	108
DreamDrive Component Locations	109
DreamDrive Limitations	111
<b>Driving Experience</b>	<b>113</b>
Steering Wheel DreamDrive Controls	113
Using DreamDrive	114
DreamDrive Requirements	114
Adaptive Cruise Control	114
Highway Assist	117
Traffic Sign Recognition	119
Traffic Drive-Off Alert	120
Distracted Driver Alert	121
Interior Camera	121
Drowsy Driver Alert	122
High Beam Assist	122
<b>Collision Detection and Protection</b>	<b>124</b>
Collision Protection	124
Automatic Emergency Braking	124
Forward Collision Warning	125
Rear Pedestrian Collision Protection	126
Cross Traffic Protection	127
Lane Departure Protection	128
Blind Spot Warning	129
Blind Spot Display	130
<b>Parking Experience</b>	<b>131</b>

About Parking Experience	131
Automatic Park In	131
Automatic Park Out	133
Surround View Monitoring	134
Rear View Monitoring	135
Park Distance Warning	136

---

## Infotainment

<b>User Profiles</b>	<b>139</b>
About User Profiles	139
Creating a User Profile	139
Profile Settings	141
Loading and Switching Profile Preferences	141
Removing Secondary User Profiles	141
Factory Reset	142
Changing Display Settings	142
Keyboard Language and Input Preferences	142
<b>Media and Audio</b>	<b>144</b>
Media Overview	144
Physical Media Controls	145
Dashboard Volume Control	146
Searching Media Content	146
Radio	146
SiriusXM®	148
Apple CarPlay®	151
Logging into Media Applications	151
Playing Media from Devices	151
Audio Settings	152
<b>Using Alexa</b>	<b>153</b>
Alexa Built-In	153
<b>Maps and Navigation</b>	<b>154</b>
Navigation Overview	154
Search	154
Navigation Settings	154
Charging Category Search	155
Routing	156
Predicting Energy Usage	158
Adjusting the Map	158
Setting Home and Work Destinations	159
Map Updates and Offline Mode	159
<b>Phone and Smart Devices</b>	<b>160</b>
Bluetooth® Wireless Technology	160
Pairing a Bluetooth Device	160
Syncing Contacts and Messages	160

Connecting and Disconnecting Bluetooth-Enabled Devices	161
Editing Bluetooth Enabled Device Preferences	161
Using the Phone App	161
Making and Receiving Phone Calls	162
In-Call Options	162
Using Messages	163
<b>Connecting the Vehicle to Wi-Fi®</b>	<b>164</b>
Add a New Wi-Fi Network	164
<b>HomeLink</b>	<b>165</b>
What is HomeLink?	165
HomeLink Regulatory Advisory	165
Programming HomeLink	166
Using HomeLink®	167
Renaming or Deleting a Program	167
<b>Vehicle Information</b>	<b>169</b>
Vehicle Identification Number	169
Direct Access to the Owner's Manual	169
Alerts and Notifications	169
<b>Software Updates</b>	<b>170</b>
Updating Software	170
Viewing Release Notes	171

---

## Mobile App

<b>Phone App</b>	<b>173</b>
Overview	173
Home Screen	173
Charging Screen	175
Map Screen	175
Vehicle Health Screen	175
<b>Watch App</b>	<b>176</b>
Apple Watch	176

---

## High-Voltage Battery Pack & Charging

<b>Electric Vehicle Components</b>	<b>178</b>
High-Voltage Components	178
<b>Battery Information</b>	<b>180</b>
About the Vehicle Batteries	180
High-Voltage Battery Pack Care	180
<b>Charging Instructions</b>	<b>182</b>
Safety Checklist	182
Charge Port Door	182
Charging the Vehicle	183



RangeXchange™	184
Disconnecting the Charging Cable	185
Charging Status	185
Setting a Charge Limit	186
Preconditioning	186
Scheduled Charging	187
Cold Weather Charging Considerations	188

---

## Maintenance

<b>Maintenance Requirements</b>	<b>190</b>
Your Responsibility	190
Scheduled Maintenance	190
Fluid Replacement	190
Owner Maintenance	190
Electrical and High Voltage Safety	191
Maintenance Schedule	192
Multi-Point Inspection	193
<b>Fluid Reservoirs</b>	<b>194</b>
Checking Brake Fluid	194
Checking Windshield Washer Fluid	195
<b>Wiper Blades and Washer Jets</b>	<b>196</b>
Checking the Wiper Blades	196
Replacing Wiper Blades	196
Cleaning Washer Jets	197
<b>Cabin Air Filter</b>	<b>198</b>
Replacing the Cabin Air Filters	198
<b>Wheels</b>	<b>199</b>
Seasonal Tire Changes	199
Wheel Covers	199
<b>Vehicle Care</b>	<b>201</b>
Cleaning the Exterior	201
Polishing, Paint, and Body Repairs	203
Using a Car Cover	203
Cleaning the Interior	203
Floor Mats	205
<b>Parts and Accessories</b>	<b>206</b>
Parts, Accessories, and Modifications	206
Body Repairs	206
<b>Vehicle Lifting Points</b>	<b>207</b>
Lifting the Vehicle	207

---

## Tires & Wheels

Tire Information	209
------------------	-----

Tire Markings	209
Understanding Tire Marking Labels	210
International Tire Approval Marks	211
Uniform Tire Quality Grading	211
Tire and Loading Information Label	212

<b>Tire Care and Maintenance</b>	<b>214</b>
Inspecting and Maintaining Tires	214
Maintaining Tire Pressures	215
Replacing Tires and Wheels	217
Seasonal Tire Types	218
Driving in Low Temperatures	218
Tire Traction Devices	219
Maintaining Wheel Trims	219
Tire Pressures at High Speeds	220

<b>Tire Pressure Monitoring System</b>	<b>221</b>
Tire Pressure Monitoring System (TPMS)	221

<b>Vehicle Loading</b>	<b>223</b>
Loading the Vehicle	223
Steps for Determining Correct Load Limit	223

---

## Technical Data

<b>Vehicle Dimensions and Weights</b>	<b>226</b>
Exterior Dimensions	226
Vehicle Weights	228

<b>Vehicle Sub-Systems</b>	<b>229</b>
Steering	229
Brakes	230
Wheel and Tire Specifications	231
Front Suspension	232
Rear Suspension	233
Motors	234
Transmission	234
12V Batteries	234
High-Voltage Battery	234

---

## Roadside Assistance & Emergency Information

<b>Roadside Assistance</b>	<b>236</b>
Contacting Roadside Assistance	236

<b>Instructions for Transporters</b>	<b>237</b>
Vehicle Towing and Recovery Methods	237
Transporting the Vehicle	238
Preparing Vehicle for Transportation	238
Towing Device Method	240
Opening the Trunk	240

Installing the Towing Device	241
Securing Vehicle for Transportation	243
Connecting External 12V Power	243
<b>Disabling the Power System</b>	<b>245</b>
Safety Precautions	245
First Responder Cut Loop	245
<b>Vehicle Fire</b>	<b>246</b>
Firefighting	246
Scene Size Up	246
Hazardous Conditions	246
Firefighting	249
After Firefighting Suppression is Complete	250

---

## Consumer Information

<b>New Vehicle Limited Warranty</b>	<b>253</b>
Warranty Information	253
<b>Customer Care</b>	<b>254</b>
Contacting Lucid Motors	254
<b>Reporting Safety Defects</b>	<b>255</b>
Reporting Safety Defects	255
<b>Vehicle Recycling</b>	<b>256</b>
High-Voltage Battery Recycling Process	256
<b>FCC, FDA, and ISED Compliance</b>	<b>257</b>
FCC and ISED Certification	257
<b>Disclaimers / Warnings</b>	<b>270</b>
California Proposition 65	270
California Perchlorate Advisory	270
Vehicle Telematics	270
Data Recording	270



01

# Introduction

---

# A Message From Lucid

Thanks for choosing **Lucid**. We're honored to have you aboard.

**Lucid Air Sapphire** is designed and engineered with a devout dedication to detail, and every aspect carefully considered. We hope you cherish this vehicle as much as we did in developing it.

This Owner's Manual will help you become acquainted with your **Lucid Air Sapphire** and includes important information on how to operate, maintain, and get the most out of your ownership experience.

Congratulations on your new **Lucid Air Sapphire** and thank you for dreaming ahead with us.

# About This Manual

## Using This Manual, Locating and Referencing Information

This Owner's Manual contains information to help you configure, maintain, and enjoy your Lucid Air. We advise you to take some time to familiarize yourself with it before driving.

Failure to follow the Owner's Manual instructions and warnings can result in vehicle damage, severe personal injury or death to you and others, and voiding the New Vehicle Limited Warranty.

To quickly find a topic, please refer to the index.

 **Note:** References to the vehicle's left or right side assume that you are seated in the car facing forward.



## Document Applicability

This Owner's Manual applies to all Lucid Air vehicles.

Lucid regularly updates this manual. The latest version is accessible via the Pilot Panel and on the Lucid website. Internet connection is required to download the most recent version of the manual.

## Symbols Glossary for Important Information

The Owner's Manual uses the following symbols for important information:

-  **WARNING:** Indicates a hazard which, if not avoided, or instruction which, if not followed, could result in severe injury or death
-  **CAUTION:** Indicates a hazard which, if not avoided, or instruction which, if not followed, could result in damage to your vehicle

 **ENVIRONMENTAL:** Indicates an instruction to observe to avoid unnecessary damage to the environment

 **Note:** Indicates additional information of a general nature useful to the reader.

## What's New

This list is a quick reference of the changes made in your Owners Manual.

### Changes to Version 25

- What's New on page 3, "What is New" section now tracks Owner's Manual changes.
- Turn Signals on page 85, additional functionality added to cancel turn signals.
- Regenerative Braking on page 91, if regenerative braking is limited, a notification will display on the Cockpit Panel.
- Reverse Tilt Mirrors on page 83, the side mirrors can be programmed to tilt down when the vehicle is in reverse to assist in parking.
- Swapping the Wheels Yourself on page 199, you can now reset the TPMS yourself after swapping different size wheels.

## Illustrations

The Owner's Manual provides illustrations to locate components or features described in the accompanying text. Depending on the vehicle specification, software version, region of purchase, and specific settings, your vehicle may appear slightly different. However, the essential information in the illustrations is correct.

Continuous improvement is a goal at Lucid, and we reserve the right to make changes at any time, without notice and obligation.

Trademarks

---

**Lucid, the Lucid logo, Air, the Air logo, Dream Edition, Air Sapphire, the Air Sapphire logo, DreamDrive, Wunderbox, Surreal Sound, RangeXchange, and Pure Spec logo are trademarks of Lucid USA Inc, its subsidiaries, and/or its affiliates.**

The Bluetooth(R) word mark and logos are registered trademarks owned by Bluetooth SIG, Inc. and any use of such marks by Lucid are under license.

All other trademarks contained in this document are the property of their respective owners, and their use herein does not imply sponsorship or endorsement of their products or services. The unauthorized use of any trademark displayed in this document or on the vehicle is strictly prohibited.

Copyright

---

©2023 Lucid USA, Inc. All rights reserved. The information presented is current at the time of publication and subject to copyright and intellectual property rights of Lucid USA, Inc. and its subsidiaries and/or affiliates. This document may not be reproduced, archived, or transmitted in any form or by any means, nor modified or replicated to other sites, without the prior written permission of Lucid USA, Inc.



# Information About This Vehicle

## Quality Control

You may notice miles/kilometers on the odometer when you take delivery of your vehicle. The mileage is a result of the comprehensive process used to ensure the quality of your car.

Our quality control process includes extensive inspections during and after production. The final inspection takes place at the delivery center and consists of a road test conducted by a trained **Lucid** technician.

## Vehicle Modifications

 **Note:** Lucid does not recommend installing non-approved parts and accessories or performing non-approved vehicle modifications. Doing so can negatively affect your vehicle's performance and the safety of its occupants. Non-approved modifications may lead to invalidation of your warranty.

 **WARNING:** Using or installing non-approved parts or accessories, or making non-approved modifications could compromise the safety and performance of your vehicle which could lead to injury or death.

 **Note:** If you have a disability that requires modifying the vehicle, contact **Lucid** before making any modifications.

## Body Repairs

If you damage the vehicle in a collision, make sure a **Lucid-approved Service Center** repairs your car only using genuine **Lucid** parts. Contact **Lucid Customer Care** at 1-888-99-LUCID (+1 888-995-8243).

For more information, see **Body Repairs** on page 206.

## Electric Vehicle Precautions

 **WARNING:** Your Lucid Air is a 100% electric vehicle, utilizing high-voltage AC and DC systems, as well as a 12-volt system. The AC and DC high-voltage systems can cause personal injury, severe burns, electric shock, and even death, unless you take appropriate precautions.





You will find a warning label affixed to several high-voltage components on your vehicle to alert you to any possible risks. Always observe and obey the instructions on the labels attached to the components on the car; they are there for your safety.

 **WARNING:** Do not touch or attempt to remove or replace any high-voltage parts, wiring, or connectors. The orange outer sleeve identifies the high-voltage wiring and connectors.

 **WARNING:** If the vehicle is involved in an accident, do not touch any high-voltage wiring or the components connected to the wiring.

---

 **WARNING:** If a vehicle fire occurs, immediately evacuate the vehicle and contact your local fire emergency responders. They possess the proper training and equipment to safely extinguish electric vehicle fires.

 **WARNING:** The vehicle contains a sealed Li-ion, high-voltage battery. Disposing the Li-ion battery improperly can risk personal injury, severe burns, electrical shock, death, and/or environmental damage.

#### Personal Information and Data Sharing

---

For information on how **Lucid** uses and protects your personal information, visit our website at [www.lucidmotors.com/legal](http://www.lucidmotors.com/legal).

#### Data Sharing Permissions

---

You can disable data-sharing from the Pilot Panel by touching **Settings > Connectivity > Data Sharing Permissions**. From here, you can toggle data sharing settings.

**Please note that disabling data sharing also disables the following features:**

- Signing in and out of your user profile
- Saving and restoring user profiles and preferences to the cloud
- Resetting user PINs
- Mobile app interactions

 **Note:** When data sharing with Lucid is disabled, third-party apps still receive and transmit data as needed by those third-party terms of use. Lucid may also still receive data and personal information regarding you and your vehicle from third parties.

02

# Vehicle Overview

---

# Exterior

## Exterior Overview

---

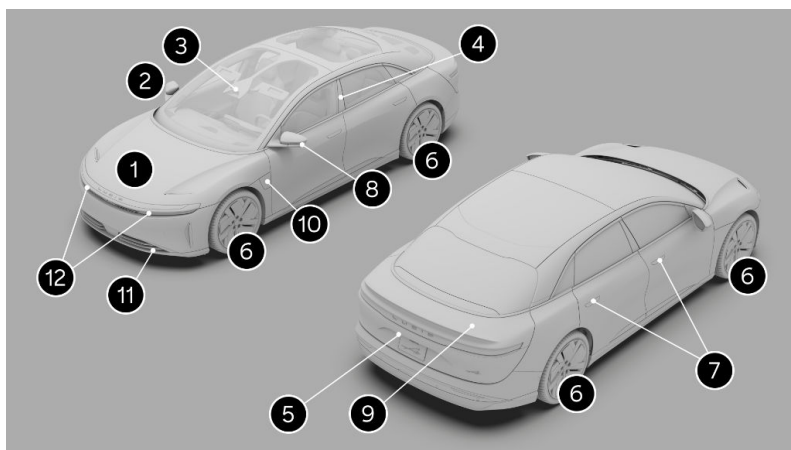

1. Hood, see Hood Opening and Closing on page 28
2. Exterior Side Mirror, see Adjusting the Exterior Side Mirror Position on page 83
3. Front Multifunction Camera
4. Pillar Camera
5. Rear View Camera, see Rear View Monitoring on page 135
6. Tires and Wheels, see Inspecting and Maintaining Tires on page 214
7. Exterior Door Handle, see Opening Doors from the Outside on page 23
8. Surround View Monitoring Cameras, see Blind Spot Display on page 130
9. Trunk Lid, see Trunk Opening and Closing on page 31
10. Charge Port Door, see Charge Port Door on page 182
11. Recovery Eye Attachment Point, see Towing Device Method on page 240
12. Headlights, see Exterior Lights Control on page 84



Note: For detailed camera locations, see DreamDrive Component Locations on page 109.

---

# Interior

## Interior Overview

---

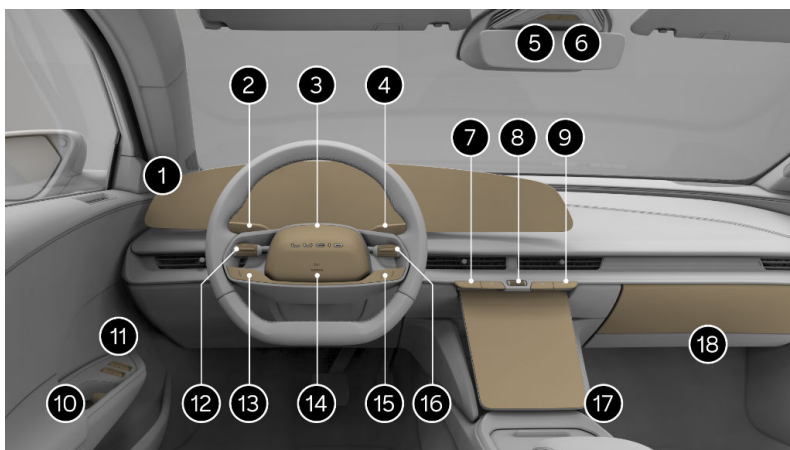

1. Glass Cockpit, see Glass Cockpit on page 14
2. Left Control Stalk:
  - Washers, see Washers on page 88
  - Turn Signals, see Turn Signals on page 85
  - High Beams, see High Beam Headlights on page 85
3. Driver Camera, (behind the steering wheel). See Interior Camera on page 121
4. Gear and Parking Brake Selector, see Using the Drive Selector on page 78
5. Hazard Warning Lights Button, see Hazard Warning Lights on page 86
6. Interior Light, see Interior Lights on page 87
7. Driver Temperature Controls, see Temperature Control on page 98
8. Volume Control, see Physical Media Controls on page 145
9. Passenger Temperature Controls, see Temperature Control on page 98
10. Interior Door Handle, see Opening Doors from the Inside on page 23
11. Window Switches, see Opening and Closing Windows on page 26



12. Left Toggle Switch, see Steering Wheel DreamDrive Controls on page 113
13. DreamDrive Controls, see Steering Wheel DreamDrive Controls on page 113
14. Horn, see Horn on page 77
15. Media Controls, see Steering Wheel - Right Controls on page 76
16. Right Toggle Switch, see Steering Wheel - Right Controls on page 76
17. Pilot Panel, see Pilot Panel on page 68
18. Glove Box, see Glove Box on page 101

## Vehicle Identification Number

You may be asked to provide the Vehicle Identification Number (VIN) when communicating with **Lucid Motors**. You can find the VIN in the following locations:

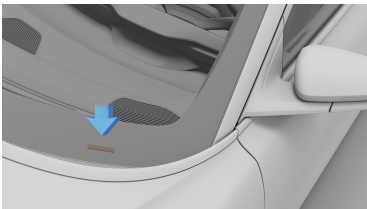
- Top of Dashboard - The VIN is visible through the lowest part of the left-hand side of the windshield.



- On the Pilot Panel, select  >  **About Vehicle** to view the VIN.
- On the floor, under the front passenger's seat, lift the cutout on the floor carpet to gain access to the VIN.



 **Note:** The VIN is also shown on the vehicle certification label and tire information label.

## Vehicle Certification Label

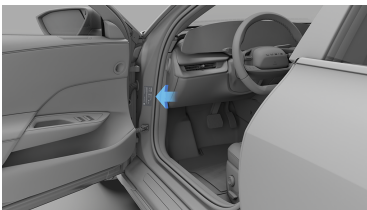
The vehicle certification label is located on the left A-pillar.



The vehicle certification label can state, but is not limited to, the following important information:

- Vehicle Manufacturer
- Vehicle Manufactured Date (MM/YY)
- Gross Vehicle Weight Rating (GVWR)
  -  **Note:** GVWR is the maximum allowable weight of the fully-loaded vehicle. This includes all options, equipment, passengers, and cargo.
- Gross Axle Weight Rating (GAWR)
  -  **Note:** GAWR is the maximum allowable weight that a single axle (front or rear) can carry.
- Vehicle Identification Number (VIN)

 **WARNING:** Do not exceed the GVWR or the GAWR specified on the vehicle certification label. Exceeding the certification label vehicle weight limits can adversely affect the performance and handling of your vehicle. Overloading may also cause permanent damage to components, which could result in a loss of control of your vehicle, serious personal injury, or death.

 **WARNING:** Do not use replacement tires with lower load-carrying capacities than the original tires, as they may lower your vehicle's GVWR and GAWR limitations. Replacement tires with a higher limit than the original tires do not increase the GVWR and GAWR limitations.



## Steering Wheel Controls



1. Left Toggle Switch
2. DreamDrive Button
3. Following Distance Button
4. Cancel Button
5. Right Toggle Switch
6. Previous Button
7. Next Button
8. Voice Assistant Button

For more information, see [Steering Wheel Media Controls](#).

The 34-inch (86 cm) Glass Cockpit is ergonomically contoured to the driver, giving the driver easy access to the controls without being distracted.

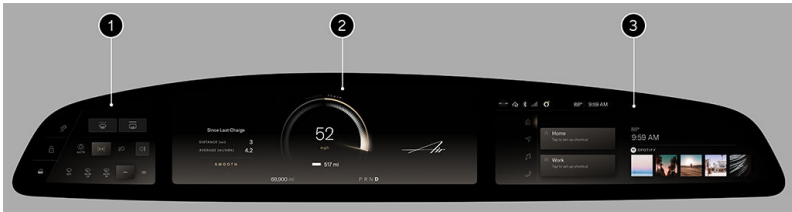

1. **Left Cockpit Panel:** The functions on this touchscreen are available at all times:
  - Charge Port Door Control, see Charge Port Door on page 182
  - Door Locks, see Opening Doors from the Inside on page 23
  - Front and Rear Windshield Defrost, see Defrost on page 99
  - Exterior Lighting Controls, see Exterior Lights Control on page 84
  - Wiper Controls, see Wipers on page 88
  - Frunk Controls, see Hood Opening and Closing on page 28
2. **Center Cockpit Panel:** This panel displays the centralized Center Cockpit Panel, with system messages and information displayed to the left and right. Any warning indicators will appear here; see Warning Indicators on page 70.
3. **Right Cockpit Panel:** This touchscreen gives you access to the following:
  - Media and Audio, see Media and Audio on page 144
  - Maps and Navigation, see Maps and Navigation on page 154
  - Communication, see Phone and Smart Devices on page 160
  - User Profiles, see User Profiles on page 139
  - HomeLink® Controls, see HomeLink on page 165
  - Bluetooth® Controls, see Connecting and Disconnecting Bluetooth-Enabled Devices on page 161
  - Wi-Fi® Controls, see Add a New Wi-Fi Network on page 164

Pilot Panel

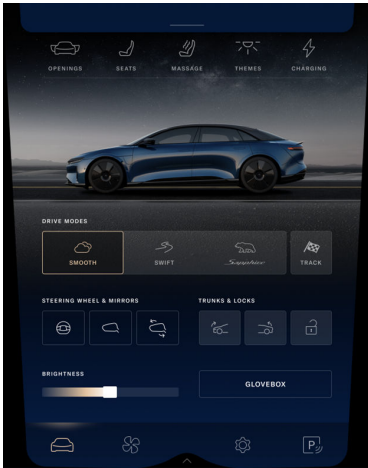

The icons along the bottom of the Pilot Panel touchscreen allow you to access:

- Vehicle Controls
- Climate Controls, see Temperature Control on page 98
- Settings Menu
- Parking Controls, see Parking Experience on page 131

Note: In some menus on the Pilot Panel, you can press the icons for list view or tile view to toggle between display options.

Note: The Pilot Panel can be retracted to access the storage space behind it. See Retracting, Extending, or Turning Off the Pilot Panel on page 68.

Smart Drawer

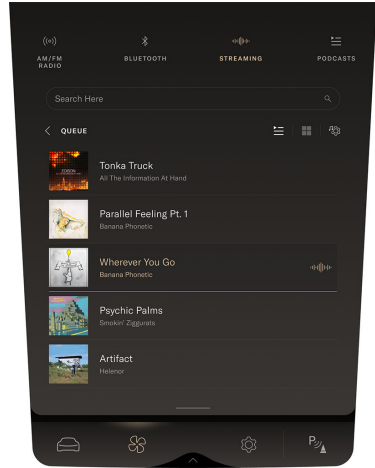
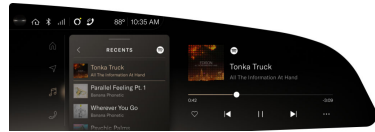

Some applications display in the smart drawer window on the right Right Cockpit Panel, allowing you to browse the contents. The Pilot Panel view of the smart drawer shows additional details for lists and libraries.

**WARNING:** Distracted driving can lead to serious injury or death. The driver should pay attention to the driving task at all times and use the smart drawer feature only when safe to do so.

To open the smart drawer in the Pilot Panel:

1. Press the bar at the top of the touchscreen.
2. In the Right Cockpit Panel, press the bar at the bottom of the touchscreen.

- 
3. Swipe the smart drawer up or down to slide it between screens.
  4. If the smart drawer collapses due to timeout on either screen, touch the bar to expand it again.

The < arrow in the upper left corner of a menu title returns you to the previous screen.



#### Rear Display

---

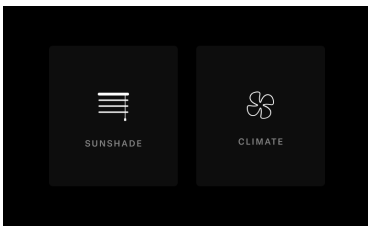
The rear display is located at the back of the center console and allows rear seat passengers to control the climate and the sunshade settings.



The rear display provides the following options for rear seat passengers:

-  Sunshade - Deploys and retracts the Rear Sunshade; see Sunshades on page 27.
-  Climate - Controls for the temperature, fan speed, and seat heating in the rear seats; see Rear Seat Heaters on page 40

 **Note:** You can lock access to the rear display by navigating to **Settings > Pilot Displays** on the Pilot Panel.

03

# Opening & Closing

---

# Keyless Entry System

## Using the Mobile Key

---

Mobile Key allows you to use your phone to unlock, drive, and lock Lucid Air using the Lucid Mobile app. In order to use the Mobile Key, you must first pair it with the vehicle.

### Pairing

You must pair the mobile device in order to access the Mobile Key functions.

1. On the Pilot Panel:
  - a. Go to **Settings > Access and Profiles > Keys**.
  - b. Press **Link Mobile Key**.
2. On your mobile device:
  - a. Open the **Lucid Mobile** app.
  - b. Press the **Mobile Key** icon in the top right-hand corner of the home screen.
  - c. Press **Link Now**.
  - d. Wait for the 6-digit passcode.
3. Confirm that the 6-digit passcode on the Pilot Panel matches the mobile device code.
4. Type a name for the mobile device on the Pilot Panel, and press **Done**.

### Unpairing

You can unpair mobile devices either from within the **Settings** in the vehicle or from the mobile device. Once unpaired, you will not be able to use the mobile device for Mobile Key functions.

#### Unpairing from the Settings App

1. Go to **Settings > Access and Profiles > Keys**.
2. Press **Edit**.

3. Press **Remove** next to the mobile device to be unpaired.

#### Unpairing from the Lucid Mobile App

1. Press the **Mobile Key** icon in the top right-hand corner of the home screen.
2. Press **Remove Vehicle**.
3. Go to your device's Bluetooth settings, navigate to the list of Bluetooth devices, and tap **Forget** for the vehicle. Depending on the OS, select **Forget** or **Unpair** to unpair your Android device. To unpair the iOS device, tap  and click **Forget this device**. You can refer to the Lucid Mobile app for additional information on the **Troubleshooting** modal.

#### Vehicle Controls

Mobile Key controls, (unlock, drive, and lock), function the same way as the passive features for the key fob.

## Using the Key Fob

---

Your vehicle includes two alternate keyless entry systems: a key fob and a Lucid key card.

 **WARNING:** The keyless entry system uses low-frequency radio transmissions that may interfere with implanted medical devices. To avoid any possibility of interference, keep such medical devices away from any transmitters.

 **WARNING:** To prevent the accidental operation of the vehicle or its systems, do not leave a key fob in a vehicle that is unattended by a driver. Never leave children unattended in the car.

- ⚠ **CAUTION:** Always secure the vehicle by removing all key fobs from the car when leaving it unattended.

### Key Fob Range

The key fob communicates with receivers in the vehicle via Bluetooth® Low Energy (LE) and low-frequency radio communication. While it is not necessary to point your key fob at the car, it must be within operating range to work.

- ✎ **Note:** The key fob operating range varies, depending upon environmental factors. Nearby radio transmitters, (e.g., amateur or CB radios, radio or television stations, airports), may interfere with communications between the key fob and the vehicle. In cases of interference, it may be necessary to move closer to the car than usual to operate the key fob.

You can manually operate the key fob once it is detected or closer to the vehicle.

While carrying a key fob, all doors will automatically unlock and present their handles when approaching your vehicle.

When leaving your vehicle while carrying a key fob, all doors will automatically lock, and any presented door handles will retract.

### Key Fob Operation

As you approach the vehicle, the key fob should be within range.

- ✎ **Note:** The key fob button is located on the center of the top surface, in the middle of the **LUCID** logo.



Once within range, the key fob operates as follows:

- Press once to lock all doors and front and rear trunks.
- Press twice to unlock all doors and front and rear trunks.
- Press and hold the button to open or close the front trunk.
- Give it a short press, followed by a long press to open or close the rear trunk.
- Press the button four times for the panic alarm to trigger; to cancel the panic alarm, press the button four times again or twice to unlock it.

### Key Fob Troubleshooting

If the key fob does not respond when pressed:

- Try operating the key fob as close to your vehicle as possible. Other radio equipment operating on a similar frequency may interfere with the signals from your key fob.
- The key fob battery may need replacing; see Replacing the Key Fob Battery. If the key fob battery is depleted, you can still unlock the vehicle by holding the key fob near the driver's side center pillar, (below the camera; the key fob should touch the pillar), then pressing the door handle for three seconds.

If you cannot unlock your vehicle with the key fob, use the mobile app or Lucid key card. See [Using the Lucid key card](#). Contact **Lucid Customer Care** if the problem persists.

#### Using the Lucid Key Card

Use the Lucid key card only within close range of the vehicle and as a backup method for vehicle entry. You may use or lend the Lucid key card when you are:

- Using a valet parking service
- Leaving your vehicle to be serviced or repaired at a **Lucid Service Center**
- Experiencing key fob issues, (e.g., misplaced or low battery)

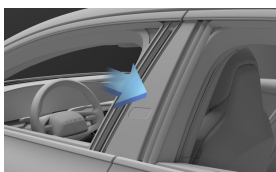

Hold the Lucid key card just above the driver's side center pillar camera to lock or unlock the doors.

-  **Note:** To drive the vehicle only using the Lucid key card, you must enter the pin associated with the current user profile when shifting out of Park.

#### Replacing the Key Fob Battery

-  **WARNING:** The key fobs supplied with your vehicle contain a coin/button-type battery. These batteries contain toxic and corrosive substances. Batteries are a chemical burn hazard and should never be ingested. If swallowed, batteries can cause severe internal burns and may even lead to death.

- Keep new and used batteries out of the reach of children.
- If you think batteries may have been swallowed, seek immediate medical attention.

 **WARNING:** If the cover for the key fob will not close securely, stop using the key fob and keep it out of the reach of children. Contact a Lucid Service Center for a replacement key fob.

 **WARNING:** There is a risk of explosion if an incorrect battery is installed. Only install a battery that is identical to the battery specified in this manual.

The key fob battery is type CR2032 and will need occasional replacement. The vehicle alerts you with a **Key Fob Battery Low** message on the Glass Cockpit.

-  **Note:** Replace a low key fob battery as soon as possible to avoid complications with the vehicle systems.

To replace the key fob battery:

1. Remove the battery cover.

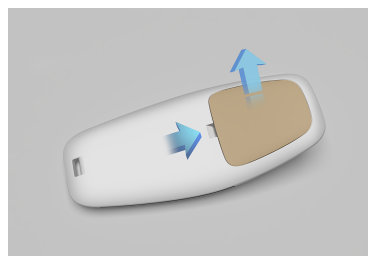

2. Remove the old battery.



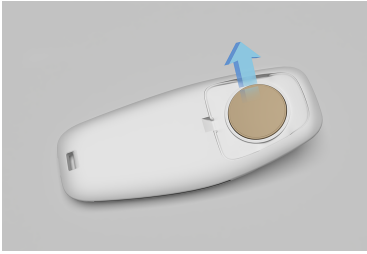

3. Avoid touching the flat surfaces of the new battery, if possible, as fingerprints can reduce battery life.
4. Wipe the battery clean before installation.
5. Fit the battery with the + side facing upwards.
6. Replace the battery cover.

 **ENVIRONMENTAL:** Used batteries must be correctly disposed of, as they contain harmful substances. Please refer to local regulations.

### Depleted Key Fob Battery

It is still possible to access the car even if the key fob battery is depleted. Press the driver's side door handle momentarily and locate the camera on the B Pillar. Place the key fob on the B Pillar under the camera, and while still holding it, move the key fob in small circles.

You can also lock the vehicle in the case of a depleted key fob. To do this, make sure the doors, frunk, and trunk are closed. Then, locate the camera on the driver's side of the B Pillar. Place the key fob on the B Pillar under the camera, and while still holding it, move the key fob in small circles.

#### PIN to Drive

When accessing the vehicle with a dead key fob or Lucid key card, drivers

must use their profile PIN to enable driving. Drivers are able to enter the PIN via the Pilot Panel after pressing the brake pedal. After entering a valid PIN, drivers can operate the vehicle until the driver's door opens again, resetting authentication.

 **Note:** After 21 unsuccessful attempts, the driver cannot enter the PIN again for 2 hours.

#### Caring for the Key Fob

 **CAUTION:** To protect the electronic circuitry inside, do not expose the key fob to:

- Impacts
- Liquids
- High temperatures (including prolonged sunlight exposure)
- Waxes, solvents, or abrasive cleaners

#### Replacement Key Fobs

If you lose a key fob, contact a **Lucid Service Center** to obtain a replacement.

If ordering a new key fob, you must bring all available key fobs and Lucid key cards for the vehicle to the **Lucid Service Center** to reprogram the system.

#### Type Approval

##### United States

This device complies with Part 15 of the FCC Rules.

Operation is subject to the following two conditions:

1. This device may not cause harmful interference.
2. This device must accept any interference received, including interference that may cause undesired operation.

---

This equipment complies with FCC radiation exposure limits set forth for an uncontrolled environment. End-users must follow the specific operating instructions for satisfying RF exposure compliance. This transmitter must not be co-located or operating in conjunction with any other antenna or transmitter.

Changes or modifications not expressly approved by the party responsible for compliance could void the user's authority to operate the equipment.

### **Canada**

This device complies with Industry Canada's license-exempt RSS standards. Operation is subject to the following two conditions:

1. This device may not cause interference.
2. This device must accept any interference, including interference that may cause undesired operation of the device.

# Doors

## Opening Doors from the Outside



### Opening Doors

The door handles will extend when:

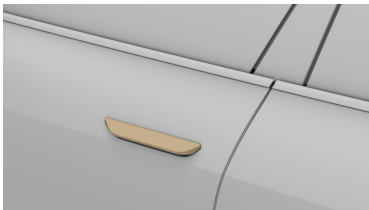
- A valid key fob is detected next to the vehicle.
- A valid key fob or Lucid key card is detected next to the vehicle on the left driver's side center pillar, and the door handle is pressed.
- The key fob is pressed twice to unlock the doors; see Using the Key Fob.
- The mobile app is used to unlock the doors.



Once a handle extends, pull up on it to open that door.

-  *Note:* If a door handle is not opened within two minutes of presenting, it will retract. Other opening methods discussed in this section can be used to extend it again.
-  *Note:* If there is a collision, all exterior door handles will present if there is still available power and the door units are not damaged.

### Closing Doors

The door handles retract when:

- The vehicle locks itself upon the user with the key fob(s) walking away from the vehicle.
- A valid key fob or Lucid key card is detected within 2 inches (5 cm) of the sensor on the left driver's side center pillar, and the door handle is pressed.
- The key fob is pressed once to lock the doors.
- The mobile app is used to lock all doors.

To close a door manually, push it until it is almost closed; you will feel the power cinch motor take over. The door will then automatically close.

## Opening Doors from the Inside

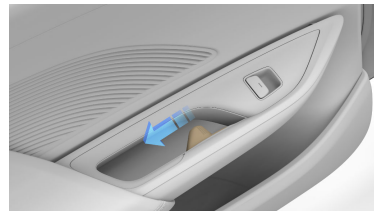

When the car is in Park, pull the release handle (highlighted above) once to both unlock and open the door.

-  *Note:* This electronic release mechanism is disabled when the vehicle is in motion.

In the event that the door loses power, pull the release handle to full travel to open.

-  **Note:** To prevent children from using the interior handles to open the rear doors, see Child Safety Locks. Rear doors will not open when child locks are engaged.

#### Door Warnings









Whenever a door is open, a warning icon appears on the Glass Cockpit and open doors are displayed.



#### Locking and Unlocking from Inside the Vehicle



The doors and trunk can be locked and unlocked from inside the vehicle using the touch screens on the Left Cockpit Panel or the Pilot Panel. To lock or unlock all the doors:





- On the **Left Cockpit Panel**, press the  **lock/unlock icon**.
- On the **Pilot Panel**, select  and press the  **lock/unlock icon**.
- On the **Pilot Panel**, select  >  **OPENINGS** and press the  **lock/unlock icon**.

When pressed, the  icon will change to a locked or unlocked symbol, indicating the current state of the door locks.

#### Child Safety Locks

Your vehicle has child safety locks on both rear doors. When active, this system prevents occupants from opening rear doors using the interior door handles.

-  **WARNING:** Child safety locks should be activated whenever children are seated in the back seats. There is a risk of severe injury or death if a child opens the vehicle doors when the vehicle is in motion. Always ensure children are also wearing their seatbelts.
-  **WARNING:** Never leave children unsupervised in any car.
-  **Note:** Exterior door handles will still operate according to the vehicle's lock status.

To toggle child safety locks, use the Pilot Panel and touch  >  **Openings**, and then touch the  icon. The  icon will illuminate when the child safety locks are activated.

#### Automatic Locking and Unlocking

Once the vehicle starts moving, all doors automatically lock. The doors will remain locked when the vehicle is in Park.

If the airbags deploy, all doors will automatically unlock, but remain latched. See Effects of Airbag Inflation on page 64.

#### Opening Interior Doors with No Power

If the vehicle loses power, you can open every door using the interior door handles.

To open the vehicle from the inside, pull the interior handle to the second detent for the manual door latch to release.

 Note: Child safety locks will be unavailable in the event of a power loss, even if they were enabled before the vehicle lost power (see Child Safety Locks).

---

# Windows

## Window Safety

---

**⚠ WARNING:** Use caution when operating the windows. Although your car is equipped with obstacle detection on all four windows, body parts like hands and fingers, pets, or objects can still be trapped or pinched by moving windows.

- Do not allow children to play with the window switches.
- Never stick objects or body parts through an open window.

**⚠ WARNING:** On hot days, the temperature in the vehicle interior can rise very quickly. Exposure to these high temperatures, for even a short time, can cause a heat-related injury or death. Small children and animals are particularly at risk and should never be left unattended in a vehicle.

## Opening and Closing Windows

---

The power windows only operate when the vehicle is powered on.

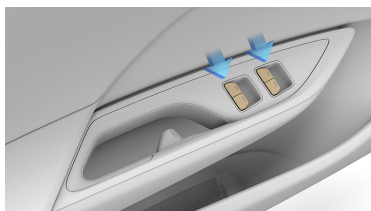

The driver's door window switches control of all the vehicle's windows. Pull up or press down on a switch to raise or lower the associated window.

Each passenger door contains a window switch for its associated window.

- To automatically raise or fully lower a window, push or pull the switch past the resistance point and then release it. Push or pull the switch again to stop.
- To partially raise or lower a window, gently push or pull the switch up to the resistance point. Release the switch when the window is at the desired position.

 **Note:** The windows will automatically stop closing and reverse if an obstruction is detected.

## Inhibiting Rear Window Operation

**⚠ WARNING:** To avoid risk of serious injury to children, rear window locks should be activated whenever a child is seated in the back seat.

**⚠ WARNING:** Never leave children unsupervised in a vehicle.

You can operate the rear windows using the switches on the rear doors when the window lock is not activated.

The window lock feature in the Left Cockpit Panel and/or the Pilot Panel prevents passengers from operating the rear window switches.

- To toggle this feature, press touch  **WINDOW LOCK** on the Pilot Panel.

The **WINDOW LOCK** button will illuminate when active.

---

## Sunshades

---

Some **Lucid Air** models are equipped with power sunshades in the rear window and both rear passenger windows. Raising the power sunshades in sunny weather conditions can reduce glare and help regulate the internal vehicle temperature.

-  **CAUTION:** The child seat tether anchor point cover must be closed when lowering the rear sunshade to prevent damage.





### Side Window Sunshades

Window switches in the rear doors also operate the side window sunshades. See *Opening and Closing Windows* on page 26

Raise a sunshade by continuing to hold the **Up** window button after the window is fully raised.

### Rear Window Sunshade

There are two ways to operate the rear window sunshade:

- On the **Rear Center Console Display** home screen, select  **SUNSHADE**, and touch **EXTEND** or **STOW**.
- From the Pilot Panel, select  >  **OPENINGS**, and touch the  sunshade icon to raise or lower the sunshade.

# Hood

## Hood Opening and Closing

The Hood is also referred to as the Front Trunk Lid or Frunk Lid

- Note: Always make sure that the hood is fully closed and secure before driving. Failure to properly secure the hood can result in sudden or unexpected hood opening which could lead to an accident causing serious injury or death.

 In the case of an unlatched hood, the red **Door Open** warning indicator will appear on the Glass Cockpit. If this occurs, **Lucid** recommends that you stop the vehicle in a safe location and place the vehicle in **P (Park)**, then check to see if the hood is correctly closed.









If the vehicle is in **D (Drive)** or **R (Reverse)** and the hood is unlatched, it will be highlighted red.

### Opening the Hood

- Note: All electrical unlatching of the hood is disabled when the vehicle is in motion.

To electronically open and close the hood:

1. Use the **Lucid mobile app**.

2. On the **Pilot Panel**, select  and press the  **hood-opening** icon.
3. On the **Pilot Panel**, select  >  **OPENINGS** and press the  **hood-opening** icon.
4. On the **left Pilot Panel**, press the  **hood-opening** icon.
5. Press and hold the key fob within 6.5 feet (2 m) of the front trunk.

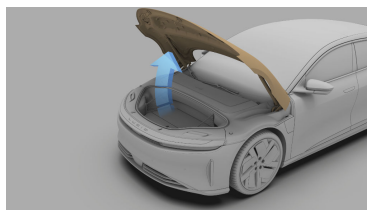

You may raise the hood after it has been successfully unlatched. The hood has two gas struts to aid in opening and holding it in the open position.





- Note: In frigid temperatures, you may find that the gas struts do not hold the hood open as firmly as they do in warmer temperatures.

### Automatically Closing the Hood

To close the hood using the power-assist system:

1. Use the **Lucid mobile app**.
2. Select the  icon and press the  **hood-closing** icon on the **Pilot Panel**.



3. Select  >  **OPENINGS** and press the  **hood-closing** icon on the **Pilot Panel**.
4. Press and release the close button on the front edge of the frunk.

 *Note:* If the hood has been open for an extended time, it may be necessary to close it manually. See [Manually Closing the Hood](#) on page 29.

3. Gently press it down until you feel the power auto-cinch take over to pull it closed.

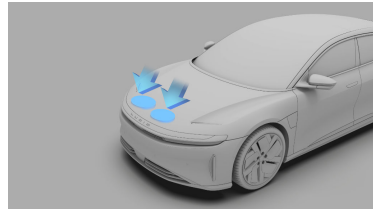

### Automatic Movement Stop

The hood will stop moving if anything obstructs and prevents it from opening or closing.

 *Note:* The Glass Cockpit alerts you if the hood automatically stops.

If the hood stops due to an obstruction, remove it and try to open or close it again. If it cannot be opened or closed a second time, try to manually operate the hood.

### Manually Closing the Hood

 *Note:* Some models may come equipped with power-opening and closing-hood systems.

 **WARNING:** Always check the area around the hood for obstructions, (such as people or objects), before closing the hood.

 **CAUTION:** Do not use excessive force when closing the hood, as the hood panel could be damaged.

4. After closing it, confirm that the latch is fully engaged by attempting to lift the front edge of the hood. The hood should be free from all movement.

 **WARNING:** If any part of the hood hinge appears loose, do not drive the vehicle, and contact a Lucid Service Center.

### Accessing the Front Cargo Area

To access the lower cargo area in the front trunk, pull up on the cargo cover handle. The cargo cover is not attached to the vehicle, therefore, it can be folded back or removed, if necessary.

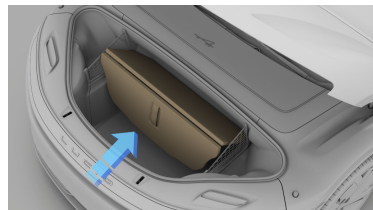

To close the hood:

1. Gently lower it until the hood is almost closed.
2. Place your hands on top of the hood at the illustrated points.

---

## Hood Interior Emergency Release

---

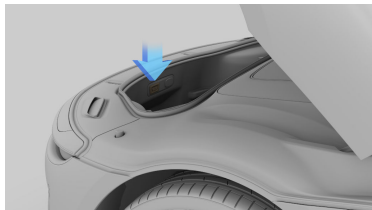

If a person becomes trapped inside the front trunk, open the hood from the inside by pressing the interior release button.

# Trunk

## Trunk Opening and Closing

- ⚠ **WARNING:** Always check the area around the trunk for obstructions before opening, closing, or operating the trunk.
- ⚠ **CAUTION:** To avoid damaging the trunk, do not use excessive force when manually operating the trunk.



To allow the trunk to operate, the vehicle must be in Park (P).



If the trunk is not fully closed when shifting the car out of Park (P), the system will illuminate with the  Door Ajar Warning indicator on the Glass Cockpit. If the car is in D (Drive) or R (Reverse) and the trunk is unlatched, the Door Ajar Warning icon will be highlighted red.



## Opening the Trunk

The trunk can be unlocked and opened by any of the following methods:



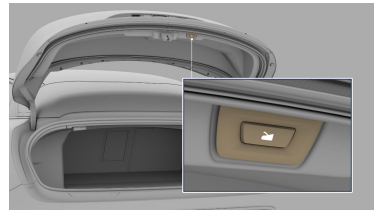

- Use the **Lucid mobile app**.
- Select  and press the  **trunk release icon** on the **Pilot Panel**.

- Select  >  **OPENINGS**, and press the  **trunk release icon** on the **Pilot Panel**.
- Use a short press followed by a long press of the **key fob** button.
- Use the **manual release button** on the trunk (located below the 'C' in the Lucid nameplate), when doors are unlocked or if you have a key fob.

## Closing the Trunk



To close the trunk:

- Use the **Lucid mobile app**.
- Select  and press the  **trunk close icon** on the **Pilot Panel**.
- Select  >  **OPENINGS** and press the  **trunk close icon** on the **Pilot Panel**.
- Press and release the close button on the lower edge of the **deck lid**.
- Manually pull the deck lid down until the power cinch engages.

 **Tools:** If the trunk has been open for an extended time, it may be necessary to close it manually. See Manually Closing the Trunk on page 32.

---

## Automatic Movement Stop

The deck lid will stop moving if anything obstructs it with enough force to prevent it from opening or closing.

 **Note:** The Glass Cockpit alerts you if the decklid automatically stops.

If the decklid stops due to an obstruction, remove it and try to open or close it again. If it cannot be opened or closed a second time, try to manually operate the trunk.

 **WARNING:** Exercise caution when opening or closing the hood and decklid in windy conditions. If a strong gust blows against the hood and decklid, it could close suddenly, resulting in injury.

 **WARNING:** Keep hands and fingers away from the area between the hood and door while closing. They may not be detected by sensors. It's good practice to keep your hands away from this area while opening or closing the hood.

## Manually Closing the Trunk

 **WARNING:** Always check the area around the trunk for obstructions, such as people or objects, before closing the trunk. Failure to do so could result in serious injury to a person or damage to the vehicle.

 **CAUTION:** Do not use excessive force when closing the trunk, as the decklid could be damaged.

To close the trunk:

1. Gently lower it until the trunk is almost closed.
2. Gently press it down until you feel the power auto-cinch take over to pull it closed.

---

## Accessing the Rear Cargo Area

To access the lower cargo area in the rear trunk, pull up on the cargo cover handle. The cargo cover is not attached to the vehicle, and can be folded back or removed, if necessary.

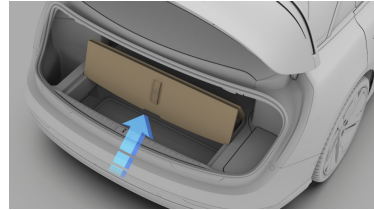

---

## Trunk Interior Emergency Release

A mechanical release, located on the inside of the trunk, allows you to open the trunk if the vehicle has no electrical power.

 **Note:** The mechanical release allows a person trapped inside to get out.

1. Pull the handle firmly outward to release the trunk latch.

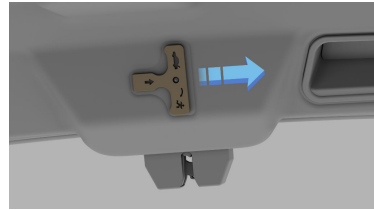



2. Push upwards on the deck lid to open the trunk.

# Safety and Security

**Safety and Security** is a settings menu item that controls most safety and security features. To access **Safety and Security**, tap the **Settings** icon on the Pilot Panel and tap **Safety and Security**.

## Tow and Break-In Alert

Vehicle sensors can detect significant impacts, intrusions, or unauthorized towing while your vehicle is in Park (**P**), and can trigger alerts and notifications.

To access **Tow and Break-In Alert** settings from the Pilot Panel, select  >  **Safety and Security**. Alternatively, use **Settings** from the Lucid Mobile App.

You can then select a notification type (both an alarm and push notification, or only a push notification), and disable the **Tow and Break-In Alert**. By default, the **Tow and Break-In Alert** is on, unless it is manually disabled (for example, towing), and it will notify you through the **Alarm and Push** notification.

Disable the **Tow and Break-In Alert** for towing or servicing. If disabled, the **Tow and Break-In Alert** automatically re-enables when you either reenter the vehicle, or the next time the car is in **Park (P)**.

 **CAUTION:** The sensor for the **Tow and Break-In Alert** is located in the center console of the vehicle and can accidentally be triggered by a large amount of force to that part of the vehicle.

## Disabling the Alarm

You can disable the **Tow and Break-In Alert** sequence (if triggered) by holding a valid key close to the vehicle or by double-clicking the **key fob** button.

04

# Seating & Safety Restraints

# Front Seats

## Adjusting the Front Seats

- ⚠ **WARNING:** Do not adjust the driver's seat while driving. Doing so increases the risk of collision.
- ⚠ **WARNING:** Before adjusting a seat, check to see that the area around it is free of obstacles.
- ⚠ **WARNING:** Do not sit in or operate the vehicle until you adjust all seats and head restraints to their proper position. Failure to adjust the seats and head restraints increases the risk of neck injury and other injuries in the event of a crash.

Front seats can be adjusted using either the seat-mounted switches or the Pilot Panel. The front headrests are manually adjustable. See Adjusting the Head Restraints on page 41

### Using the Seat-Mounted Switches

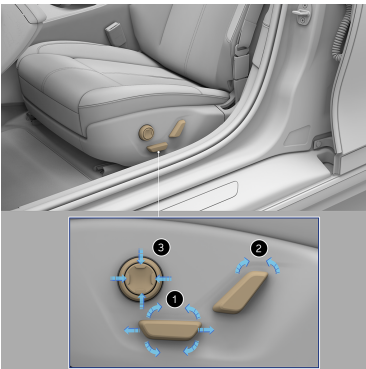

#### 1. Position

Move the seat forward/backward and adjust the seat's height/tilt the angle up/down.

#### 2. Backrest

Rotate the switch backward/forward to adjust the angle of the seat back.

#### 3. Lumbar

Press the up/down buttons to raise/lower the lumbar support, and the left/right buttons to adjust the firmness of the lumbar support.

### Using the Pilot Panel

Select > **SEATS** to adjust the seats using the Pilot Panel.

Select the seat you want to adjust using the **DRIVER** or **PASSENGER** tabs.

Select the seat area you want to adjust from the side menu and use the arrow icons to modify the seat.

- Note:** The thigh support and backrest width cannot be adjusted using the seat switches. The headrest is manually adjustable. See Adjusting the Head Restraints on page 41

After adjusting the seat position, touch the **SAVE TO PROFILE** button to save the seat position to your profile. The **RESTORE** button restores the driver seat position for the active profile. Additionally, the **RESTORE** button is only active when the vehicle is not in motion.

### Correct Seating Position

The seat, head restraint, seat belt, and airbags work together to maximize safety. Using these features correctly provides greater protection in the event of a crash.

- ⚠ **WARNING:** Seat belts are intended for use by adult-sized occupants. For children, see Child Safety on page 49.

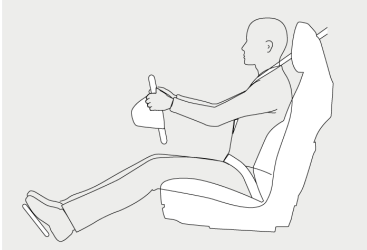

To reduce the risk of injuries in an accident, follow these instructions:

- The driver and front passenger must position their seats so that they correctly wear the seat belt whilst being as far away from the front airbags as possible.
- Sit upright, place both feet on the floor, and make sure that the seat back reclines no more than 30 degrees.
- You must be able to easily reach the pedals with your feet and slightly bend your arms while holding the steering wheel. The distance between the driver's chest and the center of the airbag cover should at least be 10 inches (254 mm).
- Grasp the steering wheel on the steering wheel rim. Hold your hands at the 3 o'clock and 9 o'clock positions to reduce the risk of injury to your hands or arms if the airbag deploys.
- Adjust the D ring position to position the shoulder section of the seat belt midway between your neck and your shoulder. Fit the lap section of the belt tightly as low and snug as possible around the hips, not the waist.

- ⚠ **WARNING:** When the seat is in the reclined position, the shoulder belt and lap belt do not provide proper protection in an accident. In a collision, with the seat reclined, you can slip past or under the seatbelt and suffer serious injury.

- ⚠ **WARNING:** Never drive the vehicle with the driver's seat reclined.

---

#### Easy Entry & Exit



Easy Entry & Exit provide more space for the drivers, making entry and exit easier. You can move the **SEATS** or, **SEATS** and **STEERING WHEEL** creating more room for the driver during entry and exit. Easy Entry & Exit moves the seat back and the steering wheel up to the highest possible position.

#### Enable Entry & Exit

To enable Easy Entry, on the Pilot Panel press  > **DOORS & SEATS** > **Easy Entry & Exit**

-  **Note:** By default, this option is OFF.

#### Enter with Entry & Exit

-  **Note:** Activate the **Easy Entry & Exit** feature.
-  **Note:** If you select **SEATS ONLY**, the steering wheel will not move.

1. When you open the driver's door, the seat and steering wheel will move to the Entry & Exit position.
2. When you close the driver's door, press on the brake, or buckle the seatbelt. The seat, mirror, and steering wheel will move to your saved profile position.



 Note: If the vehicle reaches 10 mph (16 kmph), the seat movement will automatically stop to ensure your safety while driving.

 Note: The massage feature will select the last used program and intensity if you previously used it.

**Exit with Entry & Exit**

 Note: Activate the **Easy Entry & Exit** feature.

 Note: If you select **SEATS ONLY**, the steering wheel will not move.

1. Place the vehicle in Park.
2. Open the driver's door. The seat and steering wheel will move to the Entry & Exit position.

 Note: If the driver's saved seat position is further rearward than the Easy Exit position, the seat will not move rearward on exiting with easy entry enabled. The steering wheel will continue to tilt to its maximum angle if it is not already in the maximum position on exiting.



**Disable Easy Entry & Exit**

On the Pilot Panel press  > **DOORS & SEATS > Easy Entry & Exit**.

Message Feature

---



Both front seats have a seat massage feature for comfort when seated for long periods of time.

To control the seat massage programs using the Pilot Panel, select  >  **MESSAGE**.

Select the required seating position using the **DRIVER** or **PASSENGER** tab. Select the massage program you want to use from the side menu.

Press the **START MESSAGE** button to activate the seat massage feature.

Each massage program runs for 20 minutes. A countdown showing the remaining time will show on the screen. To stop the massage program, press the **STOP MESSAGE** button.

The intensity of the massage can be increased or decreased by pressing the  or  icons.

 Note: The seat massage feature is not available in all models/trims.



Seat Heating and Ventilation

---

Both front seats have integrated seat heaters and ventilation.

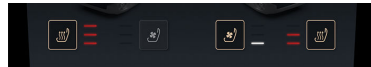
Select  to control seat heating and ventilation using the Pilot Panel. Press the corresponding icon to heat or ventilate the desired seat.



You can  heat or  ventilate the seats at three different levels:

- Press once to operate at the highest level; three intensity indicators will illuminate.
- Press twice to operate at the medium level; two intensity indicators will illuminate.
- Press a third time to operate at the lowest level; a single intensity indicator will illuminate.
- Press a fourth time to turn off the selected feature.

---

Pressing one of the two zones on the seats will deactivate heating or ventilation for that zone.

 *Note:* Seat heating and ventilation cannot be used together. Changing the seat heating to ventilation stops the seat heating and turns on the ventilation feature. Similarly, changing the ventilation to seat heating stops the ventilation and turns on seat heating.

# Rear Seats

## Rear Seat Folding

- ⚠ **WARNING:** Always secure objects transported in the passenger compartment. In an impact or sudden maneuver, unsecured objects can become projectiles and cause death or serious injury.

The split rear seat allows you to fold the entire or part of the seat forward to increase the load-carrying area. Before folding down a seat, remove any items on the seat or in the rear footwell and adjust the rear head restraints to the lowest position. See Rear Head Restraints.

The rear seat release handles are located in the trunk. To fold down a rear seat, pull the corresponding release handle. After you feel the latch release, fold the seat forward from inside of the passenger compartment.

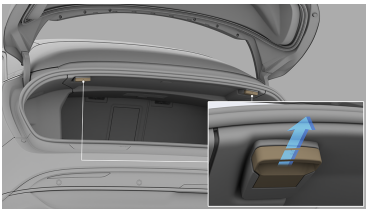

- ✎ **Note:** Use both release handles to completely fold down the entire rear seat.

## Raising

To return the seat to its upright position, push it back until it locks in place. Make sure the seat back is locked in place by trying to pull the seat back forward.

- ⚠ **WARNING:** When the seat back is in its upright position, make sure the locking mechanism fully engages. If the locking

mechanism does not fully engage, the risk of death and serious injury increases in an accident or heavy braking.

- ✎ **Note:** When returning the seat to its upright position, make sure that the seat belts are not trapped behind the backrest.

## Rear Seat Pass-Through

For your convenience, the rear seat has a pass-through hatch that allows you to carry long, narrow items without having to fold the rear seat forward.

To open the pass-through hatch:

1. Fold the rear seat armrest down.
2. Pull down on the latch and fold the pass-through hatch panel forward onto the rear armrest.



To close the hatch, push the panel up until the latch engages.

- ⚠ **CAUTION:** When passing items through the hatch into the vehicle, make sure not to damage the upholstery on the seats and the armrests.

All rear seating positions have seat heaters in the seat base and back, except the rear center seatback, which only has a heater function in the base.

Control the seat heating in the Pilot Panel, (select  > **REAR**), the rear display, or the capacitive buttons on either side of the rear display.



Press the corresponding  heat icon to heat the desired seat. You can heat the seats at three different levels.

- Press once to heat at the highest level; three intensity indicators will illuminate.
- Press twice to heat at the medium level; two intensity indicators will illuminate.
- Press a third time to heat at the lowest level; a single intensity indicator will illuminate.
- Press a fourth time to turn off the seat heater.

# Head Restraints

## Correct Head Restraint Position

- ⚠ WARNING:** Rear seat occupants must adjust the headrest to the proper position (see the diagram and description of proper alignment below) before operating the vehicle or sitting in the vehicles' seats. In the event of a crash, improper positioning can result in serious injury, paralysis, or death.

In addition to seat belts, head restraints are an important safety feature that, when used properly, can reduce the risk of personal injury (such as whiplash) in a collision. If the head restraints are not correctly adjusted, the risk of injury increases.

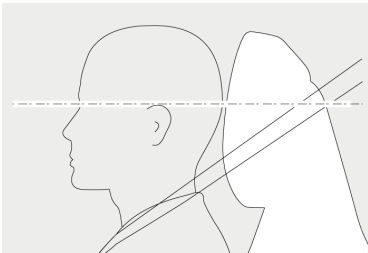

- Adjust the head restraint so the height of the restraint is at the top of the occupant's head. Doing so will place the thickest portion of the restraint behind the person's head at ear level.

 **Note:** Front seat head restraints are not vertically adjustable.

- Adjust the head restraint so the distance of the restraint is as close as possible to the back of the head.

## Adjusting the Head Restraints

Your vehicle has an adjustable head restraint for each seating position, with the exception of the rear center seat.

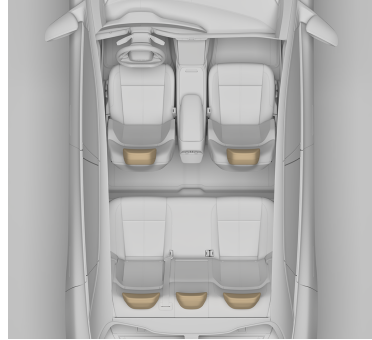

### Front Head Restraints

The front headrests of your **Lucid Air Sapphire** are designed to accommodate occupants with or without helmets. The headrest can be manually adjusted by grasping the sides and pulling gently.

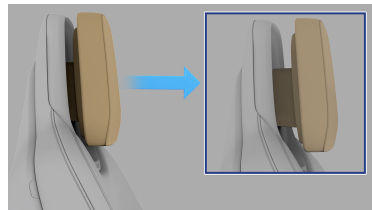

The headrest can be pulled out from its retracted position to one of three extended positions. Pulling beyond the last position will set the headrest back to its fully retracted position.

---

## Rear Head Restraints

- ⚠ WARNING:** A rear head restraint set to its lowest position is intended to provide maximum visibility out of the rear window when that seat is unoccupied. When the rear seat is occupied, the lowest headrest position may not provide adequate head and neck support in the event of a collision, and should be adjusted accordingly to fit the seat occupant.

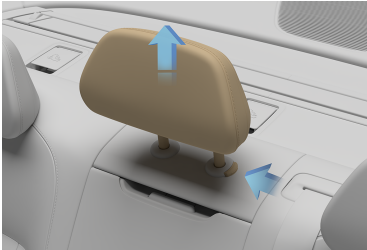

For an occupied rear seat, move the restraint upward to at least the first locked position. Make sure the head restraint is in a locked position during height adjustment.

Press the button on the side of the base to lower the headrest. To raise it, slide freely until it reaches last lock position. If the headrest is in last lock position, press the button to raise or lower it.

- ✎ Note:** The rear center head restraint is not adjustable, only removable.

## Removing a Head Restraint

- ⚠ WARNING:** The absence of a properly adjusted head restraint increases the risk of serious injury or fatality in the event of a collision.
- ⚠ WARNING:** Remove the head restraint from the vehicle seat when installing a child safety seat, (with the exception of booster seats), to ensure that the

upper tether strap securely holds the child safety seat in place.

To remove a head restraint, press the button at the base of the head restraint, and pull up until the head restraint completely slides out.

















## Reinstalling a Head Restraint

- ⚠ WARNING:** Any head restraint that has been removed must be reinstalled to properly protect vehicle occupants.

To reinstall a head restraint, locate the head restraint bars into the head restraint locating holes and push the head restraint down until a positive lock occurs. To further lower the head restraint, push the button on the base of the head restraint and push the restraint to the desired position.

# Seat Belts

## Seat Belt Warnings

-  **WARNING:** It is the driver's responsibility to ensure that the occupants of the vehicle are wearing seat belts and adhering to all warnings and guidelines listed in this section.
-  **WARNING:** Make sure that the driver and passengers correctly wear the seat belts. Improperly wearing a seat belt increases the risk of injury or death in a collision.
-  **WARNING:** Always wear the seat belt with the lap section of the belt as low as possible and snug across your hips.
-  **WARNING:** Do not wear the seat belt with any part of the strap twisted.
-  **WARNING:** Never wear the seat belt with the shoulder belt under your arm.
-  **WARNING:** Never wear a shoulder belt without the lap belt.
-  **WARNING:** Do not wear seat belts over hard, fragile, or sharp items in clothing, (for example, pens, keys, and eyeglasses). Pressure from the seat belt on such items can cause personal injury.
-  **WARNING:** Each seat belt should only be used by one occupant. Never attempt to use a seat belt with a child or another person in your lap.
-  **WARNING:** Secure small children in a proper child safety seat.
-  **WARNING:** If a seat belt cannot be securely fastened because it is not long enough, only use Lucid-approved seat belt extenders.
-  **WARNING:** Using seat belt extenders may not allow the vehicle to determine whether a seat belt unlatches.
-  **WARNING:** Do not make modifications or additions to the seat belt assembly that prevent the mechanism from taking up or removing slack. A slack belt greatly reduces the occupant's protection.
-  **WARNING:** Do not attempt to remove, repair, disassemble, or install seat belts. Lucid recommends that only Lucid-certified technicians should perform any necessary repairs. Improper handling may result in the seat belts failing to correctly operate.
-  **WARNING:** Avoid contaminating the seat belt assembly with any liquids, chemicals, dirt, grit, or cleaning products. Contamination can affect the condition and function of the assembly.
-  **WARNING:** Seat belts showing signs of wear (such as fraying), or those that have been cut or otherwise damaged must be replaced. Immediately contact a Lucid Service Center.
-  **WARNING:** If a seat belt fails to latch or does not fully retract when not in use, contact Lucid Customer Care to have the assembly inspected and possibly replaced.
-  **WARNING:** Any seat belts that were in use during a collision must be inspected or replaced by Lucid-certified technicians, even if there is no apparent damage to the assembly.

- ⚠ **WARNING:** Take care not to damage the seat belt by allowing any part of it to become trapped in the door.

#### Wearing Seat Belts

- ⚠ **WARNING:** All occupants must wear seat belts, no matter the driving distance. Failure to do so increases the risk of serious injury or fatality in an accident.

Seat belts and child-restraint systems are the most effective means of restraining vehicle occupants from impact forces, which minimize the danger of injury from interior impacts and the effects of whiplash. Wearing a seat belt is required by law in most states.

All seating positions are equipped with three-point inertia retractor seat belts. Inertia retractor seat belts are automatically tensioned and allow freedom of movement during normal driving conditions.

The seat belt retractor automatically locks, preventing occupants' movement whenever your vehicle experiences the force associated with hard acceleration, braking, cornering, or impact in a collision. The retractor may also lock when driving on steep hills or slopes.

#### Automatic Locking Retractor (ALR)

The front passenger seat and all rear passenger seating positions are equipped with an **Automatic Locking Retractor (ALR)** to securely hold child safety seats. To engage ALR mode, slowly and fully extend the seatbelt. At this point, extension of the seatbelt is disabled and only retraction is permitted to ensure that child seats are securely fastened. When the retractor is in this mode, it will produce an audible ratcheting sound when the seatbelt is allowed to retract. To disengage the ALR, allow the belt to fully retract.

- ⚠ **WARNING:** The ALR should only be used to secure child seats and not when occupants are sitting directly on the seat (not in a child seat).

The front passenger seat has an ALR.

- ⚠ **WARNING:** Child seats should only be used in the rear seats. Do not install a child seat in the front passenger seat.

#### Fastening the Seat Belt

1. Correctly position the seat. See Correct Seating Position.
2. Slowly pull the seat belt out, making sure that it is not twisted or damaged.
3. Buckle the seat belt by fully inserting the latch patch into the buckle. A distinct **click** sound will indicate that the seat belt is securely locked in place.

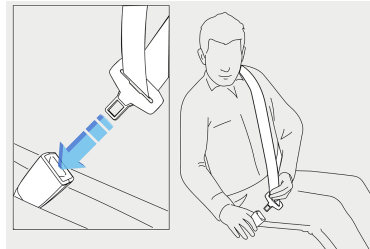

4. The height adjuster of the front seat belts can be adjusted.



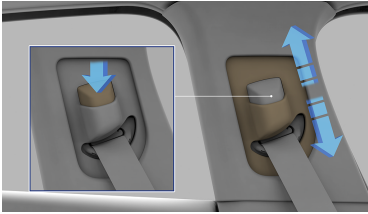

Press the button on the seat belt adjuster on the door pillar and move the belt up or down. Adjust the seat belt to the highest position possible for the seat belt to be mid-way between the shoulder and the neck, on the collar bone.

5. Tighten the seat belt across the lap and rest the seat belt on the hips by pulling the diagonal section up towards the shoulder.

### Releasing the Belt

To release the seat belt, press the red button on the buckle. The seat belt will automatically retract.

#### Seat Belt Reminders

**WARNING:** All occupants must wear seat belts. Never disregard or attempt to disable the seat belt reminder if it activates.

The seat belt reminder on the Glass Cockpit alerts you if a seat belt for an occupied front or rear seat is unbuckled.

If the vehicle speed is less than 12 mph (20 kmph), the red warning indicator will solidly illuminate, with no warning chime.

If the vehicle speed is more than 12 mph (20 kmph), the red warning indicator will continuously flash with an intermittent of chime sounds.

If all occupants are wearing seat belts and the warning indicator stays on, re-fasten all seat belts in use to ensure that they are correctly latched. Remove

any heavy objects (such as a briefcase) from unoccupied seats. If the indicator remains on, contact a **Lucid Service Center**.

In addition to the seat belt reminder, a graphic of the seat layout displays on the left side of the Glass Cockpit. The seat layout will display the detected occupied seats and the seat belt use status.



When the seat location displays a green indicator, it indicates that the seat position is occupied and the seat belt is fastened.



When a seat location displays a red seat belt indicator, it indicates that the seat position is occupied, but the seat belt is not fastened.

#### Using Seat Belts When Pregnant

**WARNING:** Pregnant women must wear seat belts to protect themselves and their unborn child.

**WARNING:** Do not place anything between you and the seat belt to cushion the impact in the event of a collision.



Wear the lap portion of the seat belt as low as possible across the hips, not the

waist. Position the shoulder part of the belt between the breasts and to the side of the abdomen. Make sure that the seat belt has no slack and is not twisted.

For any concerns about wearing seat belts, consult your physician.

#### Seat Belt Pre-Tensioners

- ⚠ **WARNING:** If a seat belt pre-tensioner activates, it must be replaced. After an impact or collision, even if there is no obvious damage, always have the seat belts checked and if necessary, replaced by a Lucid Service Center.

The seat belts for the front and outboard rear seating positions are equipped with pre-tensioners that will work either independently or in conjunction with the airbags in a severe front or side-impact collision, depending upon the severity of a crash.

- ✎ **Note:** A pre-tensioner will activate if the seat belt is already buckled at the time of the collision.

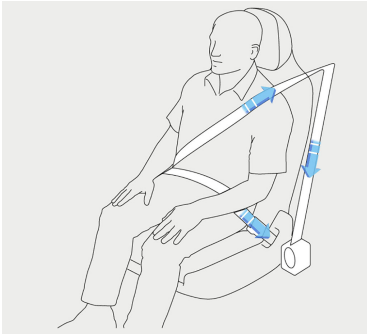

The pre-tensioners will automatically retract the seat belts, reducing any slack in both the lap and shoulder portions of the belts, thereby decreasing the forward movement of the seat belt wearer.

The seat belt pre-tensioners will only activate once before a **Lucid Service Center** must replace them.





If a pre-tensioner activates, the airbag warning indicator will display on the Glass Cockpit.

- ✎ **Note:** Even if the pre-tensioners activate, the seat belts will still function as restraints. Continue to wear the seat belts if the vehicle remains in a drivable condition.

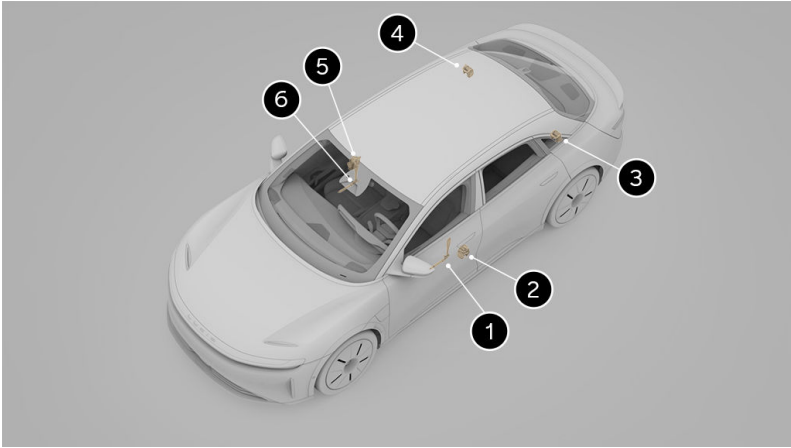
## Location of Seatbelt Pre-Tensioners



1. Driver Lap Belt Pretensioner
2. Driver Shoulder Belt Pretensioner
3. Left Rear Passenger Shoulder Belt Pretensioner
4. Right Rear Passenger Shoulder Belt Pretensioner
5. Front Passenger Shoulder Belt Pretensioner
6. Front Passenger Lap Belt Pretensioner

-  **WARNING:** Regularly check the condition of all seat belts. Replace the seat belts if you notice damage to the belt straps, fittings, retractor mechanisms, or buckles. Damaged seat belts may not provide proper protection in the event of an accident.
  
-  **WARNING:** When seat belts are not in use, they should be fully retracted and not hanging loose. If a seat belt does not fully retract, contact a Lucid Service Center.

There are three tests you should perform when checking the seat belts:





1. With the seat belt fastened, give the shoulder belt strap at the buckle a quick upward pull. The buckle should remain securely locked.
  
2. With the seat belt unfastened, unreel the belt to its limit. Check that it smoothly unreels with no snatches or snags. Visually check the belt for wear. Allow the belt to retract, checking that the retraction is smooth and complete.
  
3. With the belt half unreeled, hold the strap and quickly try to pull more of the strap out. The mechanism should automatically lock and prevent further unreeling.

If any issues arise during these tests, immediately contact a **Lucid Service Center** to have the seat belt replaced.

# Child Safety

## Guidelines for Seating Children

All child restraint systems are designed to be secured by lap belts or the lap belt portion of the lap-shoulder belt.

-  **WARNING:** Always obey all of the laws regarding the use of child safety seats and positioning of children inside a vehicle. Follow all of the manufacturer's instructions and obey all warnings that come with the child safety seat.
-  **WARNING:** Do not use a child seat on a seat with an operational airbag in front of it. There is a risk of death or serious injury when the airbag deploys. While it is possible to disable the front passenger airbag, this should not be relied upon to protect your child. Children should be placed in an appropriate child or infant restraint system that is secured in a rear seat. Crash statistics show that children are safer when properly restrained in a child or infant restraint system that is secured in a rear seating position.
-  **WARNING:** Do not use a forward-facing child seat until the child using it is above the minimum weight of 20 lb (9 kg) and able to sit up, unaided. Up to the age of two years, a child's spine and neck are not sufficiently developed to avoid injury in a frontal impact.
-  **WARNING:** A baby or infant should never be held or carried on the lap of another occupant. At all times, restrain children in age and size-appropriate child seats in the rear seat to reduce the risk of injury in a crash.

Lucid designed and fitted your vehicle's seat belts for adults and larger children. For the safety of infants and children



under 12, it is important to restrain them in a suitable child safety seat appropriate for their age and size. Fit a child seat that has been approved for use in your vehicle. Follow the manufacturer's fitting instructions, exactly. You can contact **Lucid** for a list of approved child seats. See Contacting Lucid Motors on page 254. The rear seat supports both iSize and ISOFIX child seats.

 **Note:** Legislation that governs how and where children should be carried when traveling in a vehicle is subject to change. It is the responsibility of the driver to comply with all current regulations.

 **WARNING:** NEVER place a rear-facing child safety seat in the front seat. In the event of an airbag deployment, this could lead to serious injury or the death of a child in the front seat. While it is possible to disable the front passenger airbag, this should not be relied upon to protect your child.

While it is possible to disable the front passenger airbag, this should not be relied upon to protect your child. **Lucid strongly advises that you DO NOT use a rear-facing child seat on the front passenger seat.**

## Child Safety Seat Warnings

-  **WARNING:** To ensure that children are safely seated, follow specific instructions provided by the manufacturer of the child safety seat.
-  **WARNING:** Always check and adjust every child's safety harness or seat belt for every trip.

- 
- ⚠ **WARNING:** Avoid dressing the child in bulky clothing (such as, thick or puffy coats), and do not place any objects between the child and the restraint system, as these practices could introduce slack to the restraints and reduce their effectiveness.
  - ⚠ **WARNING:** Children should never be left unattended in the vehicle, even when secured in a child safety seat.
  - ⚠ **WARNING:** According to collision statistics, children are safer when properly restrained in the rear seats than in the front seat.
  - ⚠ **WARNING:** Never use seat belt extenders on a seat belt that is used to install a child safety seat or booster seat.
  - ⚠ **WARNING:** Regularly inspect and check the installation of all child safety seats. Replace any seats or harnesses that show signs of wear.
  - ⚠ **WARNING:** Never use a child safety seat that has been in a collision. Have the seat inspected or replaced, as described in the child safety seat manufacturer's instructions.

Choosing a Child Safety Seat

- ▲ **WARNING:** Children age 12 and under should ride in the rear seats using a child safety seat suitable for the child’s age and weight.
- ▲ **WARNING:** Where consistent with applicable laws or recommended by the child safety seat manufacturer, Lucid recommends that children below the weight of 20 lbs (9 kg), and unable to sit up unaided should ride rear-facing using an integrated 5-point harness. Always obey all laws regarding the use of child safety restraints and positioning of children inside a vehicle and check to confirm that children riding in your vehicle are riding with and correctly using the appropriate restraints.

Child restraints accommodate different ages, sizes, and weight ranges of children. Many child restraints are designed to allow children to ride rear-facing. Carefully read and follow all of the instructions and warnings provided by the child safety seat manufacturer, and on all labels attached to the child safety seat.

Use the following tables to help you determine the best type of restraint for a child. There are also some general rules for each category.

Weight Group	Rear Outer Seat
<b>Group 0</b>  Under 22 lb (10 kg)	U
<b>Group 0+</b>  Under 29 lb (13 kg)	U
<b>Group I</b>  20-40 lb (9-18 kg)	U, UF
<b>Group II</b>  33-55 lb (15-25 kg)	U, UF
<b>Group III</b>  48-76 lb (22-36 kg)	U, UF

U: Universal belt rearward child restraint system

UF: Universal belt forward child restraint system

Weight Group	Rear Outer Seat
<b>Group 0</b>  Under 22 lb (10 kg)	IL

Weight Group	Rear Outer Seat
Group 0+ Under 29 lb (13 kg)	IL
Group I 20-40 lb (9-18 kg)	IL
Group II 33-55 lb (15-25 kg)	IL, IUF
Group III 48-76 lb (22-36 kg)	IL, IUF

IL: Any semi-universal LATCH/ISOFIX child restraint system

IUF: Any universal LATCH/ISOFIX child restraint system



Seating Larger Children

- ▲ **WARNING:** Make sure that the booster seat or vehicle seat properly supports the child's head. The seat back must be at or above the center of the child's ears.
- ▲ **WARNING:** Make sure to properly fit the vehicle seat belt onto the child with the shoulder portion of the belt away from the face and neck and the lap portion of the belt lying across the child's lap, not over the stomach.
- ▲ **WARNING:** When a booster seat is not in use, do not leave it loose in the vehicle. In a sudden stop or collision, it could strike the occupants or seat backs and cause serious injury. Secure the booster seat or remove it entirely from the vehicle.

If a child is too big to fit into a child safety seat, but too small to safely fit into the standard seat belts, use a booster seat appropriate for the child's age and size.

Carefully read and follow all the instructions, warnings, and labels attached to the booster seat and provided by the booster seat's manufacturer.

Always check and adjust every child's seat belt for every trip.

Children who are big enough to wear the shoulder belt properly and comfortably, and whose legs are long enough to bend over the front of the seat when their back is against the seat back, should use the seat belt in a rear seat.

Installing Child Safety Seats

- ▲ **WARNING:** When installing any child safety seat, it is strongly recommended to always remove the head restraint from the vehicle seat.

- ▲ **WARNING:** Correctly anchor the child safety seats. Incorrectly anchoring the child safety seats may result in a significant risk of injury to the child in the event of a collision or emergency braking.

- ▲ **WARNING:** After installing a child safety seat in the vehicle, do not adjust the vehicle seat, as this can loosen the safety seat attachments. Remove the safety seat before adjusting the vehicle seat position. When the vehicle seat has been adjusted, reinstall the safety seat.

Not all child restraint systems are the same, and they do not all install in the same way. There are two types of installations:

- Those that you secure to the vehicle seats by the seat belts
- Those that you secure using LATCH/ISOFIX child seat anchor points built into the rear seat frame

All new and most older child restraint systems also use an upper tether strap that is attached to an anchorage point on the parcel shelf.

- ✎ **Note:** Check the manufacturer's instructions to see which installation method to use. For some systems, you can use either installation method. Always follow the child restraint manufacturer's instructions and recommendations.

Installing LATCH or ISOFIX Child Seats

- ▲ **WARNING:** Child seat anchorages are designed only to withstand the loads imposed by a correctly installed child safety seat. Under no circumstances are they to be used for adult seat belts, harnesses, or attaching other items or equipment to the vehicle.

**⚠ WARNING:** Never attach two child safety seats to one anchor point. In a collision, one anchor point may be incapable of securing both seats.

**⚠ WARNING:** If the restraint is not correctly anchored, there is a risk of serious injury to the child in the event of a collision or emergency braking.

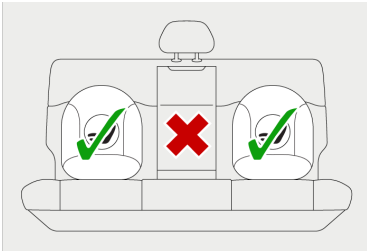

The outer rear seats are equipped to accept LATCH/ISOFIX restraints.

*✎ Note:* Only a seat belt-retained child seat can be used in the center rear seating position.

**To Install a LATCH/ISOFIX Child Seat:**

1. The lower LATCH/ISOFIX anchorage points are located between the seat back rest and rear cushion, indicated by child seat identification tabs on the seat.

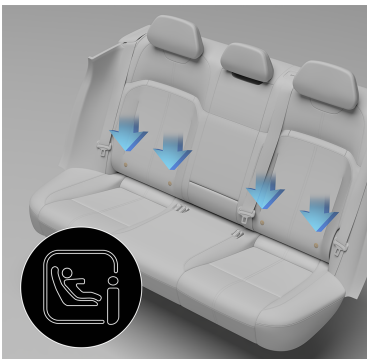

2. Position the child seat on the vehicle seat.
3. Attach the child seat latches onto the LATCH/ISOFIX lower anchor points, following the manufacturer's instructions to connect and tighten them.

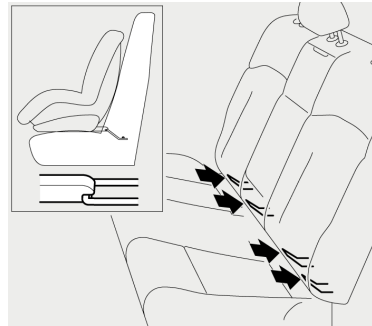

4. Securely connect and tighten the latches. To do this, attempt to pull the child seat away from the vehicle seat and twist it from side to side. Even if the child seat appears secure, visually check the anchor points to ensure correct attachment.

If the child seat moves more than 1 inch (2.5 cm) from side-to-side or front-to-back, it is too loose. If you cannot tighten the latches any further, try a different recommended seating location or another child safety seat.

5. If the child seat has an upper tether provided, correctly fit and tighten the upper tether. See Attaching Upper Tether Straps.

**⚠ WARNING:** When the combined weight of the child plus the child restraint is more than 64 lb (29 kg), you should not use the lower LATCH/ISOFIX anchors with the child seats or booster seats that have an integrated safety belt. Use the seat belt instead.

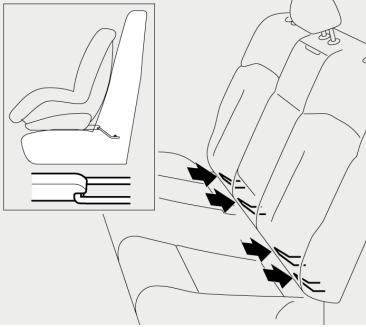

Installing Seat Belt-Retained Child Seats

First, make sure that the child falls into the correct weight range for the child seat being used. See Choosing a Child Safety Seat on page 51.

The following is a general procedure for installing a seat belt-retained child restraint. You should always read and follow the instructions provided by the manufacturer of the child safety seat you are installing.

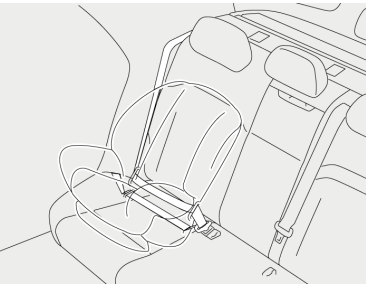

1. Place the child safety seat in the vehicle seat and fully extend the seat belt to engage the ALR. See Automatic Locking Retractor (ALR). Route the seat belt to secure the child safety seat and secure the buckle following the manufacturer's instructions.
2. Allow the seat belt to retract. Firmly push the safety seat into the

vehicle seat and remove all slack in the seat belt.

3. If the safety seat has an upper tether, attach it to the back of the vehicle seat. See Attaching Upper Tether Straps.
4. Check that the safety seat is not loose. Do this by holding the safety seat by the belt path and sliding it side-to-side and front-to-back.

If it moves more than 1 inch (2.5 cm) from side-to-side or front-to-back, then it is too loose. If you cannot tighten the safety seat any further, try a different recommended seating location or another child safety seat.

Attach a child safety seat using the lap belt or the lap belt portion of a lap-shoulder belt in accordance with the instructions of the manufacturer of the child seat.

**⚠ WARNING:** Children could be endangered in a crash if their child restraints are not properly secured in the vehicle.

Attaching Upper Tether Straps

There are upper tether strap anchors provided for each rear seating position.

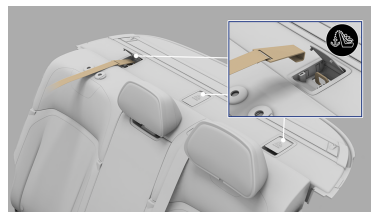

To attach the tether straps:

1. Remove the head restraint from the vehicle seat. See Adjusting the Head Restraints on page 41.

- 
2. Pass the tether strap over the top of the seat.
  3. Open the protective cover located behind the headrest.
  4. Attach the tether strap hook to the tether anchor point on the parcel shelf. Ensure that the tether strap hook is facing the correct way, according to the manufacturer's instructions, and that the strap is not twisted.
  5. Tighten the tether strap according to the manufacturer's instructions.

 **CAUTION:** The tether anchor point cover must be closed when lowering the rear sunshade to prevent damage.

# Airbags

## SRS Airbag System Components

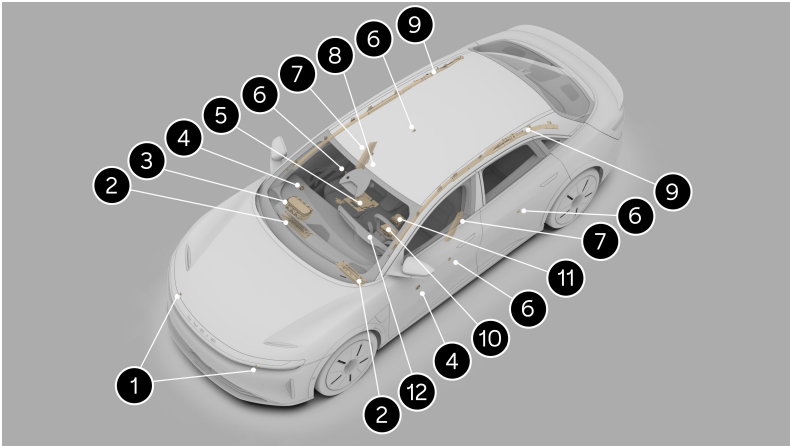

1. Front Impact Sensors
2. Knee Airbag
3. Front Passenger's Airbag
4. Side Impact Sensor (Front Door)
5. Passenger Seat OCS Sensor
6. Side Impact Sensors
7. Side Airbags (Seat-Mounted)

 Note: Driver center airbag included in Europe models only.

8. Passenger Airbag Status Indicator (Overhead Console)
9. Curtain Airbag
10. Driver's Airbag
11. Airbag Control Module
12. Airbag SRS Warning Indicator
13. Active Hood Hinges

---

 Note: This may not be available in all regions.

#### 14. Front Pressure Sensor

 Note: The illustration shows approximate airbag locations.

Airbag Safety Information

- ⚠ **WARNING:** Even with airbags, the driver and occupants must always wear their seat belts to minimize the risk of severe injury or death in the event of a collision.
- ⚠ **WARNING:** Airbags inflate with considerable speed and force. To reduce the risk of injuries, ensure that all occupants are wearing seat belts and are correctly seated, with seats positioned as far back from any front airbags, as possible.
- ⚠ **WARNING:** Never use a child safety seat or seat young children on a seat with an operational airbag in front of it. Doing so can cause serious injury or death if the airbag deploys.
- ⚠ **WARNING:** Keep hands, feet, arms, and legs away from where airbags deploy to prevent interference with their deployment.
- ⚠ **WARNING:** Contact Lucid first if you are planning to modify your vehicle for a person with disabilities in a way that may affect the airbag system. See Contacting Lucid Motors.

Airbag Safety Labels

Airbag safety labels are on the sun visors for the driver and front passenger.

How the Airbags Work

- ⚠ **WARNING:** The airbags are a supplemental restraint system, providing additional protection only in certain types of collisions; they do not replace the need to wear a seat belt.
- ⚠ **WARNING:** Occupants not properly positioned and restrained in designated seating positions are at a high risk of death or serious injury in the event of airbag deployment.

- ⚠ **WARNING:** Do not use a child restraint on a seat with an operational airbag in front of it. There is a risk of death or serious injury if the airbag deploys.

Airbags inflate when sensors detect an impact that exceeds deployment thresholds. These thresholds are designed to predict the severity of a crash in time for the airbags to help protect the vehicle's occupants.

Airbags instantly inflate with considerable force, accompanied by a loud noise. The inflated airbag and the worn seat belts limit the occupants' movement to reduce the risk of injury.

The front airbags are not designed to inflate as a result of:

- Rear Collisions
- Vehicle Rollover
- Slow Speed Front Impacts
- Side Impacts
- Driving Over Bumps or Potholes

Therefore, significant superficial damage can occur to the vehicle without the airbags inflating; or conversely, a relatively small amount of not easily visualized structural damage can cause airbags to inflate.

Types of Airbags

**Front Airbags**

The front airbags are designed to protect the head and chest of the driver and front passenger from impact with the steering wheel and dashboard panel components.

The front airbags fitted to your vehicle are advanced airbags. This type of airbag is designed to reduce airbag-related injuries to small-statured adults.

---



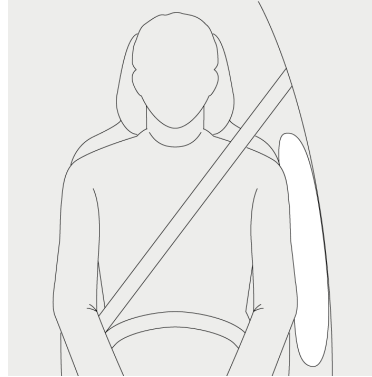

An occupancy sensor is built into the front passenger seat. If the sensor detects the weight of an infant or small child, the system will automatically turn off the passenger's front airbag. However, **Lucid** does not recommend that you seat an infant or small child in the front passenger seat.

No objects should be placed over or near the airbag on the instrument panel because the object could cause harm if the vehicle is in a crash.

 **Note:** If there is no front seat passenger detected, the passenger front airbag will not activate.



### Side Airbags

-  **WARNING:** Maintain a gap between the side of the vehicle and the torso; this enables correct inflation of the seat-mounted side airbags.
-  **WARNING:** Do not use seat covers or accessory seat covers on a front seat, because they will prevent the side airbag from correctly deploying in an accident. If in doubt, contact a Lucid Service Center.
-  **WARNING:** To ensure the correct inflation of the side airbags, maintain an unobstructed gap between an occupant's torso and the side of the vehicle.
-  **WARNING:** Lucid recommends that a Lucid Service Center performs all repairs. Incorrectly performed repairs to the side airbag system could impair function and lead to serious injury or death.

The side airbags are designed to protect the thorax region of the torso and pelvis, and only deploys in the event of a severe side impact. They do not inflate as a result of frontal or rear impacts. The airbags on the non-impacted side of the vehicle do not deploy.

### Knee Airbags

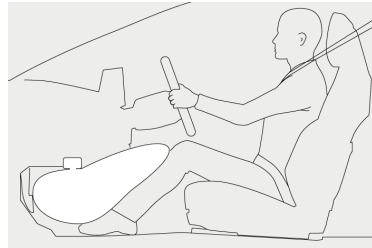

The knee airbags are designed to work in conjunction with the deployment of the front airbags. When deployed, the knee airbags limit the forward motion of the driver or front passenger by restricting leg movement, thereby positioning the occupant so that the front airbags work more effectively.



**Curtain Airbags**

- ⚠ **WARNING:** Occupants should not lean their heads against doors. In the event of a collision, the curtain airbag will deploy from the headliner and may cause injury.
- ⚠ **WARNING:** Never hang or attach heavy objects from the grab handles on the headliner. The hooks are for lightweight garments (not for hard objects).
- ⚠ **WARNING:** For the curtain airbags to correctly deploy, the roof lining and A-pillar trim must be undamaged. Any damage should be referred to a **Lucid Service Center** for inspection.

The curtain airbags are designed to protect the head in severe frontal crashes with a lateral component, severe side impacts, or rollovers. They do not inflate in all frontal impacts and do not inflate alone in a rear impact.

 *Note:* Curtain airbags can help prevent occupants from being thrown from the vehicle in the event of a vehicle rollover.

**Obstruction of Airbags**

- ⚠ **WARNING:** Do not allow passengers to obstruct the operation of the airbags by placing their feet, knees, any other part of the body, or any other objects in contact with, or in close proximity to, an airbag module.
- ⚠ **WARNING:** Front seat occupants should not place extremities including hands, arms, feet or legs against the dashboard area. An inflating airbag can cause fractures or other serious injuries.
- ⚠ **WARNING:** Do not attach or position items on an airbag cover that could interfere with the inflation of the airbag or propel inside your vehicle and injure occupants.

⚠ **WARNING:** Never place any body parts over an airbag cover as a deploying airbag can cause serious injuries.

For the airbags to correctly deploy, obstructions cannot intervene between an airbag and the occupant.

The following are examples of the type of obstructions that could impede the correct operation of airbags or jeopardize personal safety in the event of an airbag deployment:

- Accessories attached to or obscuring an airbag cover (for example, attached to the roof lining, door pillar trim, or the front seat backrests)
- Items of hand luggage, or other objects placed on an airbag cover
- Feet, knees, or any other part of the anatomy in contact with, or in close proximity to, an airbag cover
- Head, arms, or any part of the anatomy in contact with, or in close proximity to, a seat-mounted side airbag
- Objects (such as items of clothing) hanging from the handles attached to the headliner
- Objects (such as items of clothing or cushions) draped over the part of the front seat containing the airbag
- Seat covers/accessory seat covers over a front seat; in particular, seat covers that have not been designed for use with seat-mounted side airbags

 *Note:* If in doubt, consult your **Lucid Service Center**.

**⚠ WARNING:** Lucid strongly advises against seating a child on the front passenger seat, even if the passenger airbag is off. All occupants age 12 and under should ride in the rear seats. See Child Safety Locks on page 24.

**⚠ WARNING:** For the OCS to function as intended, the full weight of the front seat passenger should always be directly centered on the seat cushion. The passengers should not redistribute their weights to the armrest, center console, floor, backrest, or in any other way that reduces pressure on the seat cushion. The passenger should not place anything (such as a cushion) between themselves and the seat that could cause OCS to disable the front passenger's airbag.

Deployment of the front passenger airbag is not always beneficial for small or lower-weight occupants and could be harmful to children/infants in restraint systems.

The front passenger seat is fitted with an occupancy sensor that controls the status of the front passenger airbag based on the position and weight of the occupant.

**✎ Note:** The occupancy sensor system only controls the deployment of the front passenger airbags and passenger side airbag. It does not affect the deployment of the seat belt pre-tensioner or the passenger curtain airbag.

The occupancy sensor system meets the regulatory requirement of FMVSS 208 and automatically detects when deployment of the front passenger airbag may be unnecessary or potentially harmful.

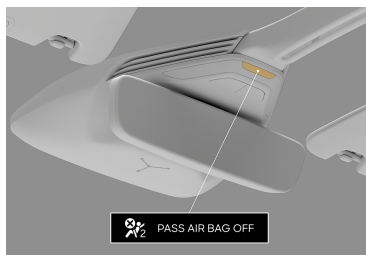

A status message on the overhead console indicates whether the front passenger airbag is currently off.

You should always check whether the passenger airbag status indicator shows the correct status for the current seat occupancy.

If you think the passenger airbag status is incorrect, check for the following:

- Objects lodged underneath the seat
- Objects wedged between the seat cushion and the center console
- Objects hanging off the back of the seat
- Cargo interference with the seat
- Rear-seat passengers pushing or pulling on the front passenger seat

Any of the conditions listed above may cause the occupancy sensor to incorrectly interpret the weight of the occupant or object as either heavier or lighter than the real weight.

Front Passenger Seat OCS Status Indicator

Depending on the input received from the occupancy sensor, the passenger airbag status indicator operates as follows:

Front Passenger Seat Occupancy	Passenger Airbag Status	Passenger Airbag Status Indicator	Airbag SRS Warning Indicator
Completely Empty/ Low-Weight Object <sup>*1</sup>	Deactivated	OFF	-
Child Restraint Seat with Infant	Deactivated <sup>*2</sup>	OFF	-
Child	Deactivated <sup>*3</sup>	OFF	-
Adult	Activated <sup>*4</sup>	ON	-
System Malfunction	Deactivated	OFF	ON

<sup>\*1</sup> A low-weight object or occupant is classified as weighing less than 52 lb (23.5 kg). The movement of a low-weight occupant or object while your vehicle is in motion may cause the status indicator to occasionally switch states.

<sup>\*2</sup> Never install a rear-facing child restraint system on the front passenger seat. A forward-facing child restraint system should only be installed on the front passenger seat when it is unavoidable.

<sup>\*3</sup> For some children (a child in a seat, booster seat, or convertible seat), the system may not recognize them as a child. Factors that may affect this can be the physique or posture.

<sup>\*4</sup> The system judges a person of adult size as an adult. When a smaller adult sits in the front passenger seat, the system may not recognize them as adults, depending on their physique and posture.

 **Note:** It is possible to receive an intermittent indicator status with an empty seat. This is part of the system's behavior and it does not affect the status of the front passenger airbags. However, if the status indicator is not permanently illuminated when the seat is empty, immediately contact a **Lucid Service Center**.

If you still believe that the airbag status indicator is incorrect, have your passenger ride in the rear of the vehicle and contact a **Lucid Service Center** to have the system checked.

-  **WARNING:** Failure to observe the following precautions regarding the front passenger OCS may cause death or serious injury:
- Wear the seat belt properly; see Wearing Seat Belts on page 44.
  - Make sure that the front passenger's seat belt latch plate is not inserted into the buckle before someone sits in the front passenger seat.
  - If an adult is seated in the front passenger seat and the **PASS AIR BAG OFF** indicator is displayed, ask the passenger to sit up straight, well back in the seat, with their feet on the floor and the seat belt worn correctly. If the **PASS AIR BAG OFF** indicator remains displayed, ask the passenger to move to a rear seat or move the front passenger seat fully rearward. In either case, contact a Lucid Service Center to help correct the issue.
  - Child restraint systems installed on the rear seat should not contact the front passenger seat back.
  - Do not recline the front passenger seat so far back that it contacts a rear seat or an object in the rear of the vehicle while the vehicle is in motion. This may cause the **PASS AIR BAG OFF** indicator to be displayed. Return the seat back to a position where it does not touch the seat or object. Keep the front passenger seat back as upright as possible when the vehicle is moving. Reclining the seat back may lessen the effectiveness of the seat belt system.
  - Make sure the **PASS AIR BAG OFF** indicator is not displayed when using a seat belt extender for the front passenger. If the **PASS AIR BAG OFF** indicator is displayed, disconnect the latch plate from

the seat belt buckle and reconnect the seat belt. If you continue to use the seat belt extender while the **PASS AIR BAG OFF** indicator is displayed, the airbags for the front passenger will not correctly activate. This could cause death or serious injury in the event of a collision.

- Do not apply a heavy load to the front passenger seat.
- Do not put objects underneath the front passenger seat.
- Do not allow rear seat passengers to put weight on the front passenger seat by putting their hands or feet on the seat back.
- Do not let a rear passenger push the front passenger seat with their legs.
- Do not allow a passenger to kick the front passenger seat or subject it to a severe impact. This could cause the Airbag SRS warning indicator to be displayed and prevent the system from operating correctly in an impact. Contact a **Lucid Service Center** if the warning indicator is displayed.
- Do not modify or remove the front seats.
- Do not modify, cover, or replace the upholstery on the front seat.

---

#### Effects of Airbag Inflation

---

-  **WARNING:** When airbags deploy, a fine powder is normally released. This powder can cause irritation. Thoroughly flush the powder from the eyes and skin, including any cuts or abrasions. The powder may aggravate asthma for some people.

- ⚠ **WARNING:** Following inflation, some airbag components are hot. Do not touch the airbag components until they have cooled.

After inflation, the airbags deflate to provide a gradual cushioning effect and to clear the driver's field of vision.

If airbags inflate or your vehicle has been in a collision, always have the airbags, seat belt, and all associated components checked and (if necessary) replaced by **Lucid**.

### Safety Features

Along with the inflation of the airbags, the following also occurs to assist you and any recovery personnel:

- Doors Unlock
- Hazard Warning Lights Turn On
- Interior Lights Turn On
- High-Voltage Power is Isolated

#### Airbag SRS Warning Indicator



You will be alerted of an airbag system malfunction with a red warning indicator on the Glass Cockpit.

The components monitored by the system include:

- Airbag Modules
- Seat Belt Pre-Tensioners
- Airbag Diagnostic Control Unit
- Crash Sensors
- Airbag Wiring Harnesses
- Seat Occupancy Sensors
- Seat Belt Buckle Sensors

When the vehicle is on, the airbag control unit monitors the readiness of the system's electrical circuits.

You should contact a **Lucid Service Center** if the warning indicator:

- Fails to illuminate when the vehicle starts
- Fails to extinguish within approximately six seconds after the vehicle starts
- Illuminates while driving the vehicle

#### Airbag Service Information

- ⚠ **WARNING:** Do not attempt to service, repair, replace, or modify any part of the airbag system. This includes wiring or components in the vicinity of the airbag components. Doing so may cause the system to trigger or render the system inoperative, either of which may result in death or serious injury.

- ⚠ **WARNING:** Any notable damage to airbag components or covers (for example, tears, burns, holes, chemical or detergent damage, or previous accidental damage), however produced, may cause the airbag module(s) to fail. Make sure a **Lucid Service Center** repairs or replaces any damaged components.

- ⚠ **WARNING:** If you need to dispose an airbag or seat belt pre-tensioner, contact a **Lucid Service Center**. Incorrect disposal procedures could cause personal injury.



05

# Driving & Operating

# Driver Information



## Vehicle Information and Alerts

---

Select  >  **About Vehicle** on the Pilot Panel to access information about your vehicle.

The screen will provide the following information:

1. Vehicle Model
2. Vehicle Identification Number (VIN)
3. Vehicle Software Version
4. Alerts That Were Recently Displayed On the Glass Cockpit

 **Note:** A notification badge will appear on the  **About Vehicle** icon if new alerts are available.

## Trip Information

---

Trip information is displayed on the left vehicle widget of the Glass Cockpit.

Select  >  **Vehicle** on the Pilot Panel to reset or change the display.

Select **Since Last Charge**, **TRIP A**, or **TRIP B** to change the trip displayed on the Glass Cockpit.

There are two trip range memories available: **TRIP A** and **TRIP B**. To reset either trip memory, press the **RESET** button next to the **TRIP** listing.

---

# Pilot Panel

Retracting, Extending, or Turning Off the Pilot Panel

---

## Retracting the Pilot Panel

The Pilot Panel can retract to reveal extra storage.



To retract the Pilot Panel, either of the following methods can be used:

- Touch and hold the arrow at the base of the Pilot Panel screen for at least one second.
- Swipe up on the arrow at the bottom of the Pilot Panel screen.

The Pilot Panel will retract into the dash, revealing additional storage space.

## Extending the Pilot Panel

While the Pilot Panel is retracted, touch the arrow on the exposed portion of the Pilot Panel. The panel will extend back to its original position.

## Turning off the Pilot Panel Display

To blank or turn off the Pilot Panel display, you can:

- Double-tap on the  on the Essentials screen.

To turn the display back on, tap anywhere on the blank Pilot Panel. The screen will also turn on automatically if the vehicle requires your input on the Pilot Panel.



# Center Cockpit Panel

## Center Cockpit Panel - Overview

 Note: The illustration below is for demonstration purposes. The information in your vehicle display may be different, depending on the current software version and market region.



1. Trip Information Area, see Trip Information on page 67
2. Charge Meter, see Charge and Power Meter on page 72
3. Power Meter, see Charge and Power Meter on page 72
4. Turn Signals, see Turn Signals on page 85
5. Navigation Widget, see Navigation Overview on page 154
6. Odometer
7. Speedometer
8. Battery State of Charge Indicator, see Battery State of Charge Indicator on page 72
9. Gear Selection Indicator, see Using the Drive Selector on page 78
10. Warning Indicator, see Warning Indicators on page 70

---

## Warning Indicators

---

The following icons may be displayed on the Center Cockpit Panel to alert you of features that are operating or any systems with faults.

For further information, refer to the relevant sections.



Anti-Lock Braking System (ABS) Disabled or System Fault Detected



Tire Pressure Management System (TPMS) - Low Tire Pressure (Solid), or System Fault Detected (Flashing)



Low Washer Fluid Level



Low Coolant Level



Headlight Leveling Fault Detected



Exterior Light Fault Detected



Rear Fog Light Active



Side/Position Lights Active



Low Beam Headlights Active



High Beam Headlights Active



High Beam Assist Enabled



High Beam Assist Fault Detected



Low High-Voltage Battery State of Charge (SoC)



12V Battery Charging System Fault Detected



High Temperature Detected for High-Voltage Battery



Low Temperature Detected for High-Voltage Battery



Brake System Warning; Stop the Vehicle; Call Lucid Service Center



Brake System Warning; Call Lucid Service Center



Excessive Brake Wear Detected



Left Turn Signal Active



Right Turn Signal Active



Airbag System Fault Detected

---

 Lane Departure Protection Disabled or System Fault Detected

 Driver's Monitoring Camera Cannot Detect Their Face

 Lucid Stability Control System is in a Reduced State

 Drowsy Driver Alert

 Collision Protection Disabled

 Lucid Stability Control Operating When Flashing; If Indicator Stays Solid, a Fault is Detected

 Collision Protection Fault Detected

 Limited Power Mode Active

 Drive Enabled

 Steering System Fault Detected

 Vehicle Hold is Currently Active and Holding Vehicle

The following warning indicators are only applicable to Canada:

 Parking Brake Applied

 Brake System Warning; Stop the Vehicle; Call Lucid Service Center

 Parking Brake Fault Detected

 Brake System Warning; Call Lucid Service Center

 Door Open or Ajar

 Excessive Brake Wear Detected

 Seat Belt not Fastened

 Parking Brake Fault Detected

 System Warning

 Parking Brake Applied

 System Alert

High-Voltage Drive System Failure

A red warning message and instructions will be displayed in the center of the Glass Cockpit accompanied by audible alerts, if the high-voltage drive system

---

detects a critical problem with the battery or drive motors.

Warnings, information, and/or instructions displayed in the left widget will accompany other Glass Cockpit indicators related to the battery or drive motors.



**High Temperature Detected for High-Voltage Battery**



**Low Temperature Detected for High-Voltage Battery**



**12V Battery Charging System Fault Detected**



**System Alert: A Detected Problem Requires Your Attention and Caution**



**System Warning: For Safety, a Detected Problem Requires Immediate Attention/Action**



**CAUTION:** There may be a reduction in performance if any of these notifications are displayed while driving, until the issue is resolved.

---

#### Charge and Power Meter

The meter that arcs over the speedometer shows the current power use of the vehicle and whether the vehicle is using or generating power.

If the vehicle is using power, then the meter fills to the right. If the vehicle is generating power, then the meter fills to the left.

---

#### Battery State of Charge Indicator

The battery icon below the speedometer shows the current State of Charge (SoC) level for the high-voltage battery pack,

along with an estimated vehicle range based on the remaining charge.

The battery pack's charge will be depleted and the icon will reflect the change in SoC and vehicle range, as you drive the vehicle or operate any of its features. Furthermore, the Glass Cockpit will display notifications while the charge level is drawn down. See High-Voltage Battery Pack Care on page 180.



A yellow, low battery indicator will display on the Glass Cockpit when the remaining battery pack charge falls below 50mi/80km.



**Note:** Lucid recommends finding a place where you can charge the vehicle if the SoC falls below 50mi/80km. Remember that the vehicle range is only an estimate, therefore, the actual drivable distance can vary depending on environmental and terrain conditions.

# Starting and Powering Off

## Starting

Your vehicle does not require a key to be turned or a button to be pressed to start it. If a paired key fob, Lucid key card, or phone is recognized when the driver's door is opened, the cockpit and Pilot Panels will power on, indicating that the vehicle is ready to operate.

### Accessory Position

The vehicle will be in Accessory position when you first get into the vehicle and sit in the driver's seat. The cockpit and Pilot Panels will also both power on.

The Glass Cockpit will show you the current vehicle status, e.g. door open and battery charge level.

All of the electrical features and controls can be operated, but the vehicle cannot be driven in the Accessory position.

 **Note:** The message **Push Brake** will be displayed if you try to select a gear in Accessory position without pressing the brake pedal.

### Drive Position

Press the brake pedal while sitting in the driver's seat, to put the car in Drive. The vehicle will search for a recognized key fob or Mobile Key. The vehicle is allowed to start if a known device is detected. If no known device is detected, a message will display on the Glass Cockpit.

The driver will be prompted to enter a PIN code before allowing you to drive if a Lucid key card is used to open the door.

See Starting on page 73.

 **Note:** You cannot put the vehicle into Drive if a charging cable is connected.

The display on the Glass Cockpit will change to show the speedometer, power meter, and the **PRND** display. The indicator lights will briefly illuminate during the system check.

 The Ready to Drive icon will be displayed on the Center Cockpit Panel.

Select a gear to drive the vehicle. See Using the Drive Selector on page 78.

 **Note:** The Drive enabled icon will disappear when the vehicle is in motion.

### Key Fob Not Detected

A message will appear on the Glass Cockpit, (when you attempt to shift out of Park), asking the driver to enter a PIN before the vehicle can be put into Drive if no recognized key fob is detected inside the vehicle.

If the vehicle still fails to start, try using another key fob or the Lucid key card. If the vehicle still can't be started, please contact **Lucid**.

 **Note:** Several factors impact the key fob's detection. These include a low key fob battery, radio frequency interference from other devices, and objects between the key and receiver.

### Key No Longer Detected

A warning message will be displayed on the Glass Cockpit if your vehicle is in Drive and the vehicle can no longer detect the key fob inside the vehicle.

- 
-  Note: Always make sure you have the key fob with you before making a journey because you will be unable to restart the vehicle once it is powered off.

#### Powering Off

---

When you have finished driving and have selected **P** (Park), the parking brake will engage and all systems will remain operational.

-  Note: If the vehicle is not in 'Park' and is stationary, when the driver door is opened, the vehicle will automatically shift to P (Park).

The vehicle will power down after 15 minutes if the key fob is still detected in the area and the brake pedal has not been pressed.



If a key is in the area, and no activity is detected, the Pilot Panel will display a countdown timer (30 seconds with an audible chime). If the countdown is not interrupted, the vehicle will retract the door handle, wait another 10 minutes, fold the mirrors, and finally sleep after an additional 5 minutes. The doors will unlock if the door handle is pressed before the vehicle sleeps.

---

# Steering Wheel

## Adjusting the Steering Wheel Position

---

Use the Pilot Panel to adjust the steering wheel position by touching  > .

Press the **Up/Down/In/Out** arrows to adjust it. Press **RESTORE** to return to the previous position, or press **SAVE TO PROFILE** to save the position to the current user profile.

Press **X** to close the application.

## Steering Feel and Sensitivity

---

The feel and sensitivity of the steering system is determined by the current driving mode selected for the vehicle. See Drive Modes.



1. For information about the left controls, see Steering Wheel DreamDrive Controls on page 113.
2. The right controls modify the volume for all media, audio, and phone calls:
  - Push up to raise the volume.
  - Push down to lower the volume.
  - Press the center button, (<1 second), to play/pause, take an incoming call, or mute the microphone during a call.
  - Give the center button a long press, (>1 second), to end an active call or reject an incoming call.
3. Press this to skip to the previous song or station.
4. Press this to skip to the next song or station.
5. Press this to use voice commands.



## Horn

---



To sound the horn, press the center pad on the steering wheel.

# Drive Selector

Using the Drive Selector

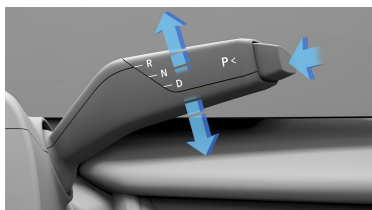

With the vehicle in **P Park** or **N Neutral**, move the right steering column lever up or down to select Reverse or Drive. The Center Cockpit Panel shows the current selection. When in Park, you must also press the brake pedal before selecting **D Drive** or **R Reverse**.

 *Note:* If you try to make a selection that is prohibited due to the current vehicle speed, a chime will sound and a message will display on the Glass Cockpit.

## R (Reverse)

Push the lever up and release to select **R**. Reverse can only be selected when the vehicle is stationary or if its forward speed is less than 5 mph (8 kmph).

## N (Neutral)

This allows the vehicle to roll freely unless the brakes are applied.

To shift into Neutral while in Park, push the Drive Selector up or down to a halfway point of resistance, and hold for one second. Release once the car shifts to Neutral.

To shift into Neutral while in either Drive or Reverse, push the Drive Selector in the opposite direction of the currently selected gear. Hold at the halfway

resistance delimit for one second, and release once the car shifts to Neutral.

 *Note:* If the vehicle's electrical system is unresponsive, the operator will need to connect a 12v jumpstart battery to the jumpstart terminal to shift to Neutral.

## D (Drive)

Push the lever down and release to select **D**. You can only select Drive when the vehicle is stationary or its speed is less than 5 mph (8 kmph) in reverse.

## P (Park)

When **P** is selected, the parking brake will automatically apply. With the vehicle stationary, press the end of the gear selector to select Park.

 *Note:* **P** is automatically engaged when you connect a charging cable to the charging port. This is to prevent the vehicle from moving while still connected.



 *Note:* If the vehicle is in **D** or **R**, **P** will automatically be selected if you open the driver's door and get up from the driver's seat.

 **WARNING:** It is the responsibility of the driver to always ensure that the vehicle is in Park before exiting. Never rely on the vehicle to automatically shift into Park.

## Vehicle Creep

 **WARNING:** Do not rely on Creep to keep your vehicle stationary on a hill. Always apply the brake to remain stopped when on a hill to avoid collisions or property damage.

---

Creep is enabled or disabled via the Pilot Panel. Select  >  **Vehicle > Drive Settings** to enable/disable Creep.

Releasing the brake pedal and tapping the accelerator when Creep is on will cause the vehicle to slowly move forward in **D** (Drive), or backward in **R** (Reverse). It may be necessary to apply the accelerator on steeper slopes or hills to move the vehicle forward.

When Creep is off, the vehicle will either be in a free-rolling state or hold stationary, depending on the selected drive settings.

# Drive Modes

## Drive Modes

Your vehicle can be set to your preferred driving and regenerative braking modes. You can opt for more comfortable and less responsive vehicle controls in order to increase energy efficiency.

Use the Pilot Panel to select a drive mode by touching .

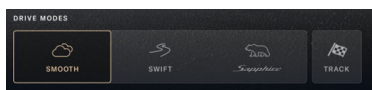

### SMOOTH

**SMOOTH** mode configures the vehicle for comfortable, effortless, highly-efficient driving. **SMOOTH** mode allows the vehicle to achieve maximum range while optimizing steering, braking, and suspension systems for comfort and a smooth powertrain response.

**SMOOTH** mode is the vehicle's default mode. Your vehicle will always be set to **SMOOTH** mode when it is first powered up.

### SWIFT

**SWIFT** mode is designed for spirited driving and gives an excellent combination of sportiness and comfort. Steering, braking, and suspension systems are optimized for a dynamic driving experience when activated. The powertrain responsiveness, available power and torque will be increased. The drive mode will return to **SMOOTH** upon powering the vehicle off and on again.

### SAPPHIRE

**SAPPHIRE** mode combines incredible power and torque with sporting reflexes and agility, for the ultimate on-road driving experience. It is designed

for short duration bursts of intense performance and enables the maximum power and torque of your vehicle. Steering, braking, and suspension systems are optimized for stability and control.

 **WARNING:** It is recommended that this mode is only used by advanced and skilled drivers, in a suitable environment, and with Lucid-specification summer tires installed.

 **Note:** This mode cannot be selected if the vehicle is using the guest profile. Please log in to enable this mode.

### TRACK

**TRACK** mode optimizes the vehicle for competitive track use. The vehicle is configured for maximum performance, with a focus on control, precision and power. This mode is designed for use on smooth tracks, and should not be used on public roads. To use this mode, you must select it and agree to a disclaimer. The drive mode will return to **SMOOTH** upon powering the vehicle off and on again, and the disclaimer requirement will reset.

 **WARNING:** It is recommended that this mode is only used by advanced and skilled drivers on a closed course, and with Lucid-specification tires installed.

 **Note:** For maximum performance, the vehicle should be pre-conditioned prior to the first track run.

 **CAUTION:** DreamDrive features are disabled in **TRACK** mode.

## Regenerative Braking

Within each regenerative brake setting, changing the drive modes will impact the regenerative braking effectiveness. Press and hold a drive mode to change your regenerative brake settings:

- High
- Standard

For more information, see Regenerative Braking.

### Launch Mode

Launch Mode maximizes the straight-line acceleration of the vehicle from a standstill by pre-loading torque applied to the traction motors. Launch Mode is available only when the vehicle is in **SAPPHIRE** or **TRACK** drive modes.

### Launch Mode

-  **WARNING:** Launch Mode should be used only on a closed course by a properly trained driver.

Enter Launch Mode by controlling the brake and accelerator pedals together.

1. First fully press the brake pedal:

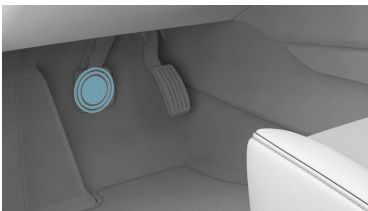

2. Then fully press the accelerator while still holding the brake pedal:

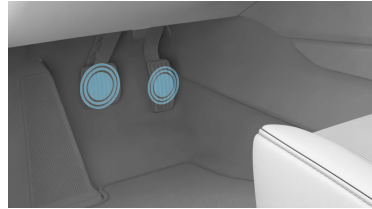

You will receive an indication you have entered Launch Mode on the Glass Cockpit Panel:



3. To launch, release the brake while still holding the accelerator:

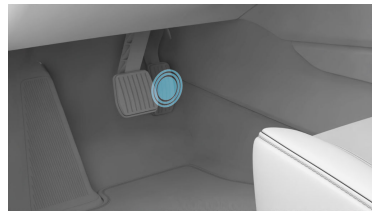

### Canceling Launch Mode

To cancel Launch Mode, release the accelerator while still holding the brake pedal.

Launch Mode will automatically cancel if the car enters a turn or if you lift your foot off the accelerator pedal.

-  **Note:** If you cancel Launch Mode, you must wait at least 10 seconds before you can re-engage it.

---

## Stability Control During Launch Mode

To achieve the best straight line performance, leave stability control in **FULL**. When in **FULL**, stability control switches to a traction optimized setting during Launch Mode. If stability control is in **TRACK**, traction control remains in the **TRACK** setting.

sustained operation of the vehicle.

## Warming up Tires

To achieve the best dragstrip and launch times, tires should be warm. This is achieved by using tire warmers, driving 5-6 small figure-eights at the grip limit of the tires, or performing a burnout (by setting stability control to OFF, then performing a launch) shortly before the dragstrip launch.

 **Note:** This driving-based method of tire warming should only be performed where it is safe and legal to do so.

---

## Limited Power Mode

 **CAUTION:** It is recommended that you travel in the lane of slower moving traffic and be prepared to stop, when driving in Limited Power Mode.

Limited Power Mode automatically activates to protect the powertrain if a fault is detected by the vehicle's drive controller. The vehicle power is reduced and speed and performance are limited, when activated.

 An indicator will be displayed on the Glass Cockpit, when Limited Power Mode is active.



Do not panic if Limited Power Mode activates while you are driving. You should still be able to drive your vehicle with reduced performance. Pull off the road when it is safe to do so and call roadside assistance. See Contacting Roadside Assistance on page 236.

 **CAUTION:** Limited Power Mode should NOT be used for the

# Mirrors

## Adjusting the Exterior Side Mirror Position

- ⚠ WARNING:** Distances may be difficult to judge accurately, depending on the type of mirror glass fitted to your vehicle. Furthermore, objects viewed in the mirror may be closer than they appear.

Use the Pilot Panel to adjust the side mirror position by touching  > .

1. Press the **LEFT** or **RIGHT** button to select the mirror.
2. Press the **Up/Down/In/Out** arrows to adjust it.



Once adjusted, press **RESTORE** to return to the previous position or select **SAVE TO PROFILE** to save the settings to the current user profile.

Press **X** to close.

### Reverse Tilt Mirrors

The side mirrors can be programmed to automatically tilt down when you shift into reverse. This can assist you while parking.

### Folding and Unfolding

To manually fold/unfold the exterior side mirrors via the Pilot Panel, press  > .

- ✎ Note:** You cannot fold/unfold the mirrors when the vehicle's speed is greater than or equal to 10mph / 16 kmph. Folded mirrors will automatically unfold once the vehicle's speed is greater than 10 mph / 16 kmph.

## Heating and Defrosting

The exterior side mirror defrost feature activates when the rear defrost button is turned on. See Defrost for more information.

### Interior Rear View Mirror

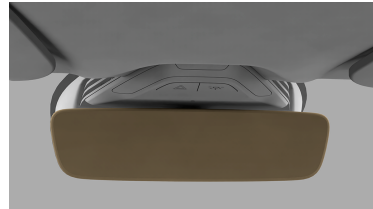

Manually adjust the rear view mirror's position for the desired view behind you.

The mirror will automatically dim in proportion to the level of glare detected from a vehicle's headlights.

- ✎ Note:** This feature is disabled when the vehicle is in **R** (Reverse) to provide an unimpeded view.

# Exterior Lights

## Exterior Lights Control

The exterior vehicle lights are controlled via either the left lever on the steering column or the Left Cockpit Panel.



Touch the corresponding icon to operate the exterior lights, accordingly:



**AUTO Lights**



**Position Lights**

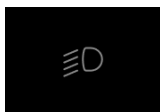

**Low Beam Headlights**

## AUTO Lights

The low beam headlights will automatically switch on when the ambient light falls below a pre-defined level. The front and rear position lights, as well as the license plate lights, are always on.

The headlights will switch off when the ambient light rises above that level.

 **Note:** The lights will switch on whenever the windshield wipers are operating.

## Position Lights

 The position lights indicator is displayed on the Glass Cockpit whenever the position lights are on.

## Low Beams

 The low beam indicator is displayed on the Glass Cockpit whenever the low beams are on.

## Daytime Running Lights

 **Note:** The functionality and operation of daytime running lights will vary according to market requirements.

In regions that require the vehicle's lights to be on even during the day, the daytime running lights will automatically turn on when the vehicle is powered, and will turn off if the headlamps or the fog lights are on.

## Light Failure

 If the vehicle detects an exterior light that is not working, the light failure indicator will be displayed on the Glass Cockpit. This will be accompanied by a message explaining which light function has failed. In the case of a failure of a turn indicator only: In addition to the aforementioned message, the frequency of the tell-tale indicator (on the Center Cockpit Panel), and audio chime will double to help alert the driver that a lamp is not operating normally.



High Beam Headlights

 **Note:** The headlight high beams will only operate if the low beams are on, except when used for temporary flashing.

Push the left steering column lever away from you to turn on the high beam headlights. To cancel, pull the lever towards you. High beams will only operate if the low beams are on.

 The high beam indicator will display on the Glass Cockpit when high beams are on.

**Headlight High Beam Flash**

You can flash the headlight high beams by pulling the lever towards you and releasing it.

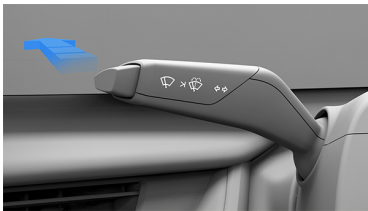

Rear Fog Light

 **Note:** Regulations concerning fog lights usage vary by country.

The rear fog light is considerably brighter than ordinary tail lights and should only be used to help other road users see your vehicle in low-visibility conditions, such as fog or heavy snowfall.



Use the Left Cockpit Panel to turn the rear fog lamp on or off.

 The rear fog light indicator will display on the Glass Cockpit whenever the rear fog light is on.

 **Note:** The rear fog light is automatically turned off each time the vehicle is powered on, and will need to be manually turned on, if required.

 **Note:** The rear fog lights can be turned on only when the headlights are manually turned on or in AUTO mode at night.

Turn Signals

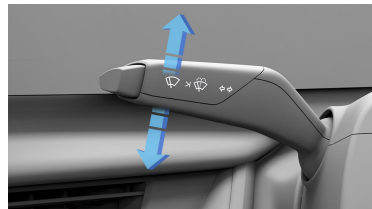

The turn signals are activated by moving the left steering column lever down to operate the left turn signals, or up to operate the right turn signals. The turn signals will continue to function until they are automatically canceled via the steering wheel or by lightly pushing the steering column lever in the opposite direction. You can also cancel by gently

---

pushing the stalk in the same direction from the idle position once more.

 *Note:* Pushing the steering column lever all the way in the opposite direction will switch the turn signals to the opposite direction instead of being canceled.

 The corresponding turn signal indicator will display on the Glass Cockpit when a turn signal is activated. You will also hear a clicking sound when the turn signal is operating.

### Lane Changes

Momentarily hold the lever up or down against the spring pressure and release it to signal a lane change. The turn signals will flash three times to indicate a lane change.

### Hazard Warning Lights

---

 *Note:* The hazard warning lights can be operated even when a key fob is not in the vehicle.

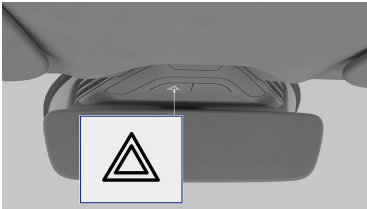

Press the switch located on the overhead console to turn on the hazard warning lights. All turn signals will flash along with the turn signal indicators on the Center Cockpit Panel.

Press the switch again to turn off the hazard warning lights.

 *Note:* You should only use hazard warning lights in an emergency to warn other road users of a breakdown or a potential danger. Remember to switch them off

when the hazardous situation has been resolved.

### After a Collision

If you are involved in a collision that causes the airbags to be deployed, the hazard warning lights will automatically switch on.

# Interior Lights

## Interior Lights

The interior lights automatically switch on when a vehicle door is opened and off when all doors are closed.

### Front Seats

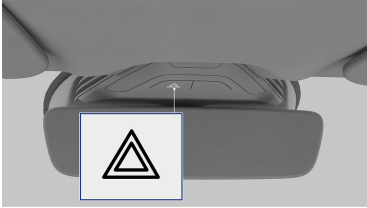

Use the switch located on the overhead console or individually touch either light to turn the front interior light on or off.

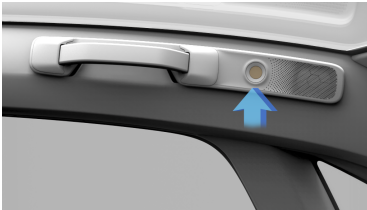

### Rear Seats



Press the center of the lamp lens to turn either of the two rear passenger reading lights on or off.

## Ambient Lighting

Ambient lighting illuminates the footwells, cup holders, and accent areas with your choice of colored lighting.

Press  >  **THEMES on the Pilot Panel** to customize ambient lighting.



 **Note:** If enabled, the ambient lights activate whenever the

vehicle is on. If ambient lighting is turned off, it will remain off until you turn it back on.

Tap an ambient lighting theme to select it. You can use the center color wheel to customize brightness, if desired. Furthermore, the center section of the color wheel has an ambient lighting on/off switch. If it is turned off, the touch interface will disappear until you switch ambient lighting back on.

# Wipers and Washers

## Wipers

-  **CAUTION:** Do not activate the wipers if they are frozen to the windshield because this can damage the wiper blades and the wiper motor.
-  **CAUTION:** Do not activate the wipers on a dry windshield because this can damage or cause unnecessary wear to the wiper blades.

Refer to the following control wiper icons in the Left Cockpit Panel:

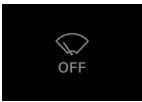

Off



In **AUTO**, the vehicles rain sensor detects whether or not it is raining and will activate the wipers, as required. The sensitivity of the wiper activation is selected by the **LO** or **HI** icons.



**LOW** Speed Continuous Wipe

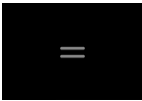

**HIGH** Speed Continuous Wipe

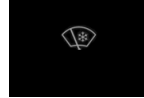

**DE-ICE:** Activate the wiper de-ice feature when there is ice/snow build-up on the windshield to assist in quick ice removal. This feature can only be activated when the vehicle is in Park and sufficient washer fluid is in the washer reservoir.

-  **Note:** Intervals between wipes reduce as the vehicle's speed increases.

## Washers

-  **WARNING:** Operating the washers in cold weather can cause the fluid to freeze on the windshield, potentially obscuring your vision and causing a collision. Use the windshield heater to warm the windshield to reduce the possibility of the fluid freezing.

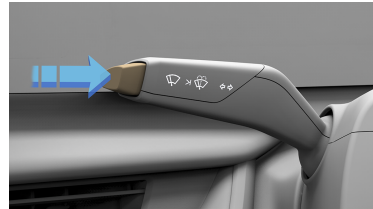

The left steering column stalk button is used for wiper controls. To get a single dry wipe, press the button to the first detent once or press and hold at the first detent for multiple dry wipes. To spray the washer fluid, press the button to the second detent or press and hold at the second detent for multiple wash-wipe cycles.

The wipers will operate with washer.  
Release the button to stop the washer.  
The wipers will make several extra  
sweeps after the button is released.





The warning indicator will display on the Glass Cockpit if the fluid level in the washer reservoir is low.

-  **CAUTION:** Do not operate the washers when the fluid reservoir is empty or frozen. This can cause the washer pump to overheat and fail.

# Brakes

## Braking Systems

-  **WARNING:** It is critical to occupant safety that your braking systems are always functioning properly. Contact a Lucid Service Center immediately if you experience any braking issues or receive any fault messages regarding the braking system.
-  **WARNING:** Driving through heavy rain or water can have a temporary adverse effect on braking efficiency.
-  **CAUTION:** Do not rest your foot on the brake pedal while the vehicle is in motion, unless you are applying the brakes because it can cause premature brake wear.

The foot pedal hydraulically-operated brakes are electrically boosted, but only when the vehicle is on. If the vehicle loses power when driving, you will need to apply more force on the brake pedal (which will cause longer stopping distances).



A red brake indicator and a notification message will display on the Glass Cockpit if the brake fluid level in the reservoir is low.



Red Brake Indicator (Canada Only).

See [Checking Brake Fluid](#) on page 194.



A brake system fault has been detected if the yellow brake indicator displays on the Glass Cockpit. Contact a **Lucid Service Center** as soon as possible.





Yellow Brake Indicator (Canada Only).



**Note:** New brakes normally produce minor noises during a break-in period (during which the brake pad and rotor optimize their surface contact area and friction force). A typical break-in period is approximately 20-25 stops from 35 mph (56 kmph) or higher.

## Anti-Lock Braking System (ABS)

-  **WARNING:** Always maintain an appropriate distance from the vehicle in front because ABS cannot overcome the physical limitations of trying to stop the vehicle a very short distance.
-  **WARNING:** The braking distance on road surfaces that are wet, slippery, or loose is always increased (even for vehicles equipped with ABS).
-  **WARNING:** Always drive with due care and attention to your surroundings and road conditions. ABS will not correct driver errors.

Your vehicle is equipped with an Anti-lock Braking System (ABS) that helps prevent the wheels from locking during hard braking or braking on roads with reduced grip.

The ABS monitors the speed of each wheel during braking and varies the brake fluid pressure at each wheel to prevent the wheels from locking. This system helps maintain steering ability during maximum brake application.

When ABS activates, you may experience the following conditions:

- Pulsations in the Brake Pedal
- A Slight Drop of the Brake Pedal
- Clicking or Grinding Noises
- ABS Warning Indicator Flickering on and off as the System Activates

These conditions demonstrate that ABS is operating and are not a cause for concern. Therefore, you must maintain a firm and steady pressure on the brake pedal while experiencing the pulsation.

### Emergency Braking

-  **WARNING:** Do not pump the brake pedal because this interrupts the operation of the ABS system and increases your stopping distance (which could lead to a collision).

Fully press the brake pedal in an emergency, even when the road surface is slippery.

### Secondary Collision Mitigation System

The secondary collision mitigation system, or post-collision braking system, automatically triggers the vehicle brakes if the vehicle detects a crash. The system is designed to activate the electric park brake automatically after the vehicle comes to a standstill.

The driver can override the secondary collision mitigation braking by either fully depressing the accelerator or brake pedal.

### ABS Warning Indicator



The ABS indicator displays with a notification message on the Glass Cockpit. If illuminated, the ABS is disabled. Contact a **Lucid Service Center** as soon as possible to have the fault repaired.

-  **CAUTION:** The pedal-operated braking system remains operational even when ABS is disabled. Be aware that braking distances may increase and wheels may lock under heavy braking.

### Regenerative Braking

-  **WARNING:** High regenerative braking can cause aggressive traction control when driving the vehicle in snowy/icy conditions. **Lucid** recommends switching to **Standard** when driving in such conditions to avoid possible loss of control.

Regenerative braking slows the vehicle and feeds energy back to the high-voltage battery whenever the vehicle is moving and your foot is off the accelerator.

Although you should still use the brake pedal whenever it is needed to stop safely, you can take advantage of regenerative braking by anticipating your stops and reducing accelerator pedal position.

-  **Note:** The brake lights turn on to alert others that you are slowing down if regenerative braking is aggressively slowing your vehicle (such as, when your foot is completely off the accelerator pedal at highway speeds).





---

During regenerative braking, the charge/power meter that arcs over the speedometer shows the current amount of energy being generated and fed back to the high-voltage battery.

The amount of generated energy being fed back to the high-voltage battery vary depending on the current state of the battery and the regenerative braking setting being used. For example, regenerative braking may be limited if the battery is extremely hot or cold or if the battery is already charged to its maximum allowable level. If the regenerative braking is limited, a notification will display on the Cockpit Panel.

-  **Note:** You'll notice a difference in driving behavior if the regenerative braking levels become limited. In that case, you may need to apply the brake pedal more frequently in such conditions.

### Regenerative Braking Settings

On the Pilot Panel, press  >  **Vehicle > Drive Settings**, then click to select between two levels of **Regenerative Braking**:

- **Standard** - Provides the standard amount of regenerative braking.

The vehicle takes longer to slow down and coasts further than if set to **High** when you release the accelerator.

- **High** - Provides the maximum amount of regenerative braking.

The vehicle decelerates faster and reduces the need to use the brakes when you release the accelerator.

The **Air Sapphire** will retain the selected regenerative braking setting when the vehicle is power cycled.



For more information, see Drive Modes.



---

### Vehicle Hold

Vehicle Hold controls brake settings and can keep your vehicle stopped even when your foot is not on the brake pedal.

When set to HOLD, the vehicle remains stationary after a stop. The brakes will hold until the driver presses the accelerator pedal again. If it is set to ROLL, the car rolls freely after releasing the accelerator.

To configure, use the Pilot Panel and touch  >  **Vehicle > Drive Settings**, then select the desired mode.

-  **Note:** Brake settings, (HOLD/ROLL), can only be changed when the vehicle is in P (Park), and will save to your user profile.
-  **Note:** Vehicle hold disengages if the driver shifts into **N** (Neutral), or presses and releases the brake pedal.
-  **Note:** Vehicle Hold will disengage and shift into **P** (Park) in any of the following instances:
  - The hold has been braking for approximately 10 minutes.
  - The system detects that the driver has exited the vehicle.

---

### Parking Brake

-  **CAUTION:** You will not be able to select another gear in the unlikely event that your vehicle loses electrical power, and therefore, will be unable to release the parking brake. Contact a **Lucid Service Center** for assistance.

The parking brake operates on the rear wheels, independent of the pedal-operated brake system.



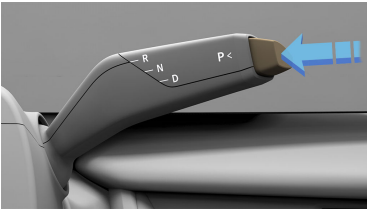

The parking brake automatically applies when **P** (Park) is selected, and releases when any other gear is selected. It is also engaged by certain systems when a time limit is reached. See Vehicle Hold on page 92.

**PARK** The red parking brake indicator is displayed on the Glass Cockpit when the parking brake is engaged. A flashing indicator signals either operating with a fault or a parking brake stuck in operation.



This is the red parking brake indicator (Canada only).

**PARK** If the indicator is amber, a fault has been detected and the parking brake may not be applied when the vehicle is in **P** (Park). This will be accompanied by a notification on the Glass Cockpit. Contact a **Lucid Service Center** to have the fault repaired.



This is the amber parking brake indicator (Canada only).

### Emergency Use

Pressing and holding the **P** (Park) button in an emergency decelerates the vehicle to a low speed using the service brakes, then applies the parking brake.

**CAUTION:** Driving the vehicle with the parking brake applied or repeated use of the parking brake to slow the vehicle may

cause serious damage to the brake system.

### Parking on a Slope

- WARNING:** In snowy or icy conditions, the rear wheels may not have sufficient traction to prevent the vehicle from sliding when parked on a slope. You are always responsible for parking safely.
- WARNING:** The vehicle will give audible and visual warnings if you are parking on too steep of a grade for the parking brake to securely hold the vehicle. Drive to a less steep area and re-park.

As an added precaution:

- If your vehicle is parked on a hill and facing uphill, turn the steering wheel so the front wheels are pointing away from the curb.
- If your vehicle is parked on a hill and facing downhill, turn the steering wheel so the front wheels are pointing towards the curb.

### Brake Pad Wear

- WARNING:** Neglecting to replace worn brake pads can damage the brake rotors, reduce the vehicle's braking efficiency, and increase the distance needed to stop the car.

The brake pads installed on your vehicle are equipped with wear indicators, which will cause the vehicle to display warning messages when the brake pads are nearing the end of life. Contact an authorized Lucid Motors Service Center to replace the brake pads.



If the red brake wear indicator displays on the Glass Cockpit, the system has detected excessive brake wear. Contact a **Lucid Service Center** as soon as possible to have the brakes inspected.



CANADA ONLY. If the red brake wear indicator displays on the Glass Cockpit, the system has detected excessive brake wear.

Contact a **Lucid Service Center** as soon as possible to have the brakes inspected.

#### Carbon Ceramic Brakes

The **Lucid Air Sapphire** is equipped with a high performance carbon ceramic brake system. Carbon ceramic brakes weigh considerably less than conventional cast-iron brakes, greatly reducing unsprung weight. They also have much better braking response, higher fading stability, and very little brake dust.

#### Burnishing Carbon Ceramic Brakes

**Lucid** recommends to carefully burnish the system when new to ensure optimal performance and component life. These burnishing procedures should be performed in non-public, safe environments.

On-road carbon ceramic brake burnishing procedure:

1. Select **SWIFT** drive mode, and select **STANDARD** regenerative braking.
2. From 60mph (97kmph) brake moderately (approximately 0.5g deceleration) to a stop. If your deceleration is correct, the stop should take around 5.5 seconds.
3. Repeat the previous step 10 consecutive times.
4. Drive for 3 miles (5 km) at 50-70mph (80-113kmph) to cool the brakes.
5. Repeat the above steps.

On-track carbon ceramic brake burnishing procedure:

1. Select **SWIFT** drive mode, and select **STANDARD** regenerative braking. Drive at 30% of the maximum pace for 3 minutes.

2. Drive for a further 3 minutes, gradually increasing your pace until at 80% of the maximum pace.
3. Cool the brakes by driving at 30% of the maximum pace for a further 6 minutes, maintaining vehicle speed above 50mph (80kmph) where safe to do so to ensure good airflow over the brakes.

#### Carbon Ceramic Brake Squeal

Carbon ceramic brakes may exhibit squeal or groan noises in certain situations, such as, but not limited to, when the vehicle is driven hard, or when the brakes are cold and/or damp. These noises are normal and are typical of high performance carbon ceramic brake systems.

#### Variable Carbon Ceramic Brake Torque Output

Carbon ceramic brake systems give variable brake torque output and brake pedal feel according to brake temperature. This is normal and typical of high performance carbon ceramic brake systems.

**⚠ WARNING:** Be prepared to apply the brake pedal more firmly and allow for longer stopping distances when the brake system is cold (such as in cold and/or snowy environments, or during the first few minutes of driving in the morning) or hot (such as during or after spirited driving).

**⚠ WARNING:** Stability and traction control performance may be degraded when the brakes are cold.

#### Increased Brake Wear During Track Use

Spirited driving and track use cause additional wear and tear on any vehicle. It is important to visually inspect safety-relevant components such as tires, brake pads, brake calipers, steering and suspension before and after each track driving session.

**Importance of Brake Cooldown After Hard Driving**

Carbon ceramic brake systems can reach very high temperatures during spirited driving or track use. To ensure that the brake fluid and neighboring suspension components are not subjected to high temperatures, after hard driving, drive at 50-70mph (80-113kmph) for 3 miles (5km) or 3 minutes to give sufficient airflow and cooldown time before the vehicle is held stationary or parked.

# Lucid Stability Control

## Lucid Stability Control

The **Lucid Stability Control** system uses multiple sensors to monitor driver inputs and vehicle motion. Under certain driving conditions, the system helps perform the following functions:

- It controls brake pressure to reduce wheel slip on one slipping drive wheel so the power is transferred to a drive wheel on the same axle that is not slipping.
- It controls brake pressure and traction motor output to reduce drive wheel slip.

It controls brake pressure at individual wheels and traction motor output to help the driver maintain control of the vehicle in the following conditions:

- One condition is under-steering (sometimes called **washout**); this is when the front wheels are turned and the vehicle does not respond but continues straight, causing the front tires to lose traction.
- The second condition is over-steering (sometimes called **fishtailing**); this is when the rear tire loses traction during a turn and causes the rear of the car to swing out further than intended.

 **WARNING:** No electronic system can remove the need for safe driving practices. Although the **Lucid Stability Control** system helps maintain control of the vehicle under certain driving conditions, it cannot prevent any accident that may occur due to unforeseen road conditions (e.g. black ice, standing water, etc.),

or result from careless/dangerous driving techniques.



This indicator will flash on the center Glass Cockpit if the **Lucid Stability Control** system activates while driving. The indicator will remain on if a fault is detected.

### Lucid Stability Control Settings

On the Pilot Panel, press  >

 **Vehicle** > **Drive Settings**, then select one of the three levels of **Lucid Stability Control**:

- **FULL** - This setting is recommended for most driving conditions.
- **TRACK** - Provides a more dynamic driving experience. It is not available in **SMOOTH** mode.
- **OFF** - Disabling stability control significantly reduces traction control and should only be disabled by advanced drivers on closed courses. It is not available in **SMOOTH** mode.



Note: You will be prompted for confirmation when turning **OFF Lucid Stability Control**.



The indicator will illuminate on the Glass Cockpit throughout the drive cycle if the **Lucid Stability Control** system is set to **TRACK** or **OFF**.



Note: The **Lucid Stability Control** system defaults to **FULL** when the vehicle is restarted.

---

# Getting Maximum Range

---

## Driving Tips to Maximize Range

---

- Remove any unnecessary cargo to reduce vehicle load weight.
- Ensure your tires are maintained at their specified inflation pressures. See Maintaining Tire Pressures on page 215.
- Keep all windows closed, when possible, to reduce drag.
- Avoid abrupt and/or frequent acceleration and try to maintain an even speed.
- When it is safe to do so, use one pedal driving techniques to gradually slow the vehicle using regenerative braking, rather than friction braking. See Braking Systems on page 90.
- Switch to Smooth Mode. See Drive Modes on page 80.
- Limit the use of the heating and air conditioning controls, when possible. Using seat heaters to keep warm is a more energy-efficient alternative than heating the entire cabin.

---

# Heating, Ventilation Air Conditioning

---

## Temperature Control

---

Cabin heating, ventilation, and air conditioning is divided into four zones: The driver and passenger side in front, and the left and right sides in the rear.

These zones can be simultaneously or individually adjusted using the Pilot Panel, the rear center console display, or the buttons on the dash.

 *Note:* Some **Lucid Air** models use a heat pump for climate control. When operating cabin cooling or heating, you may hear some faint electrical motor sounds. This is normal.

### Pilot Panel Climate Controls

On the bottom of the Pilot Panel, press . Press **FRONT** or **REAR** to access the controls for those zones. Use the sliding bars to adjust the temperature and fan speed for that zone. Slide the bar all the way down to turn the fan off.

 In the **FRONT** panel, this controls all zones, front and rear. In the **REAR** panel, this controls only the rear zones.

 Press this button to turn air conditioning on or off.

 Press this button to turn maximum cooling on or off.

 Press this button to switch between air circulation modes. Cabin air can be continuously recirculated, or a blend of fresh and cool air can be drawn from outside.

 *Note:* Avoid recirculating cool interior air for extended

periods, as this can fog up the windows.



Front Windshield Defrost; See Windshield Defrost



Rear Defrost and Side-View Mirrors; See Defrost on page 99



Activating this feature maintains the current cabin temperature after exiting the vehicle for 45 minutes.

 *Note:* You will be prompted to confirm your selection.

 *Note:* This feature automatically disables when the battery drops below 50 miles (80 kilometers) of range.



Press this button to open the Advanced Settings menu. The Automatic seat and steering wheel temperatures (if equipped) will automatically trigger seat heating or ventilation in extreme cold or heat when entering the vehicle to help occupants get comfortable as quickly as possible.



Zone fan speed and vent modes are both automated by the system based on the set temperature when this feature is on.

---



This causes all climate control states to synchronize with the driver zone, (temperature value, fan speed value, and vent modes).



Note: SYNC will turn off if a passenger adjusts a control while it is on. The control settings for the other zones remain as they were previously set in SYNC.



Press an icon to turn the fan for that area on or off. Multiple areas can be simultaneously selected.

### Front Temperature Control Buttons

Buttons on the dash can adjust the temperature and fan speed for the driver and front passenger. Move a button up or down once to change the temperature or fan speed by  $\pm 1$  increment. Press and hold the toggle to raise or lower by multiple increments.

The Right Cockpit Panel will open a small peek window along the bottom of the display when using the temperature control buttons. This window displays the current temperature and fan settings and updates according to the control interactions. Changed settings will be highlighted.



Note: The peek window will disappear after either a few seconds of inactivity or if you touch or swipe anywhere on the screen to dismiss it sooner.

### Rear Center Console Display

Select **Climate** on the main menu to access the controls for the rear zones. To return to the main menu, press on the bottom bar and swipe up.

Press an arrow once to change the temperature or fan speed by  $\pm 1$  increment or press and hold adjust by multiple increments.



Note: Climate controls will automatically turn off if the system does not detect any passengers in the rear seats.

### Remote Climate

Remote Climate is available within the **Lucid** mobile app and allows you to remotely set the cabin temperature or windshield defrosting controls.



Note: Any changes to the temperature controls via the Pilot Panel will cancel the feature when Remote Climate is activated.

### Defrost

#### Windshield Defrost



Press the icon on the Left Cockpit Panel or from the Pilot Panel screen to defrost the windshield. Note that the icon will highlight when activated.

The heat and fan speed will switch to high settings once pressed, and the air flow will be directed through the vents at the base of the windshield.



Note: Any changes to the temperature controls via the Pilot Panel will cancel the feature when front defrost is activated.

#### Rear Window Defrost



Press the icon on the Left Cockpit Panel or the Pilot Panel screen to activate the rear window defroster. The icon will highlight when activated.

The defroster will automatically turn off after approximately 15 minutes.

### Max Cool

Max Cool enables occupants to activate maximum cooling in the cabin with just

---

one press. It rapidly cools down the vehicle cabin in hot conditions.

Max Cool overrides the fan and temperature control settings. The fan speed is set to maximum and the temperature to the coolest. Front Seat ventilation of the occupied seats is set to maximum.

 *Note:* When the vehicle is powered on Max Cool is turned OFF by default.

### **Max Cool ON**

Select Climate on the Pilot Panel and select . When activated, the icon is highlighted and the HVAC controls are updated to indicate maximum cooling.

### **Max Cool OFF**

Select the Max Cool button again to turn it OFF. When turned OFF, all HVAC settings revert to the previous state.

 *Note:* If you change the temperature or fan speed in any zone, the Max Cool turns OFF.



# Interior Equipment

## Sun Visors

To use a sun visor, fold it down from its stowed position. Sun visors can also pivot towards the side window by releasing it from the retaining clip.

-  **Note:** Make sure the sun visor is secured by the retaining clip when returning it to its stowed position.

Both sun visors have a covered mirror. Raise the cover to use the mirror and an integrated light will automatically turn on. The light will turn off when the cover is closed.

### Sun Visor Battery Replacement

-  **WARNING:** Each sun visor contains three coin/button type batteries. These batteries contain toxic and corrosive substances. Batteries are a chemical burn hazard and should never be ingested. If a battery is swallowed, it can cause serious internal burns and may even lead to death.

- Keep new and used batteries out of the reach of children.
- If you think batteries may have been swallowed or placed inside any part of the body, seek immediate medical attention.

The sun visors use batteries to power the mirror lights due to the unique design of the vehicle.

-  **Note:** The batteries have an estimated life of approximately two years, based on typical usage.

To replace the batteries:

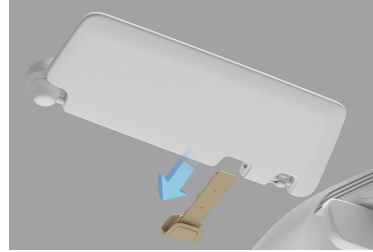

With the sun visor in its stowed position, slide the battery holder towards the front of the vehicle.

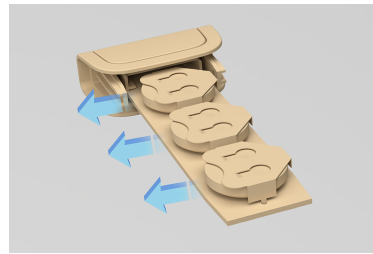

Remove the old batteries.

Install the new batteries and avoid touching the flat surfaces of the batteries, if possible, (as finger marks can reduce battery life). Wipe the batteries clean before installation. Fit the battery with the + side facing upwards and reinstall the battery holder in the sun visor.

-  **Note:** Always replace all three batteries with new 2450HT batteries.

## Glove Box

The glove box is opened using the Pilot Panel. Select  > **GLOVEBOX**. To close

it, push the glove box cover until it latches.

#### Front Armrest and Storage Compartment

**⚠ WARNING:** Do not operate the vehicle with the storage compartment lid open, as this could result in injury in a collision.

Slide the cover to access the front cup holders and storage area.

Pull the release latch and lift up the armrest to access the storage compartment.

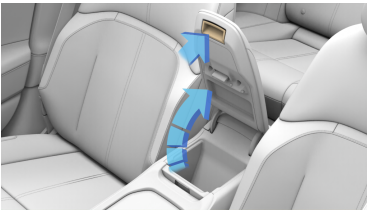

#### Center Console Storage Compartment

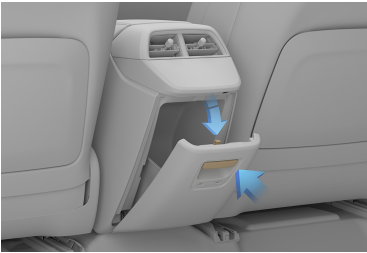

Pull the latch to release the storage compartment cover and allow it to open. Press the cover to close.

#### Rear Armrest and Storage Compartment

**⚠ WARNING:** The rear armrest must not be used as a seat or a booster cushion for small children. Children must be seated in a seat suitable for their

size and weight to reduce the risk of injury in a crash.

Use the latch to pull down the rear center armrest.

Pull up on the lid to access the storage compartment. Close the lid and push the armrest up to close it.

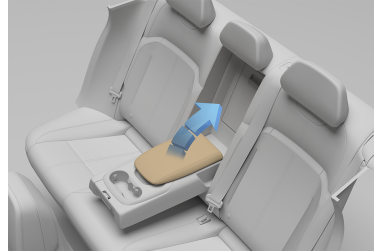

#### Cup Holders

**✎ Note:** The cup holders have a rubber insert that can be removed to allow them to be cleaned if there is a spillage.

Cup holders are located in the following locations:

1. In the front center console.

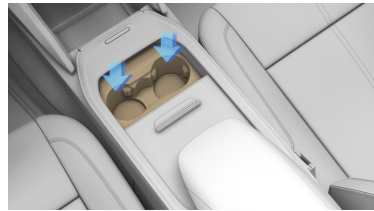

Slide the cover rearwards to access the cup holder.

2. In the rear arm rest.



Fold down the rear armrest to access the cup holder.

---

# Accessory Connections

## USB Connections

---

USB-C ports for charging mobile devices can be found in the following areas:

1. Two USB-C ports can be found in the storage compartment of the front center console.

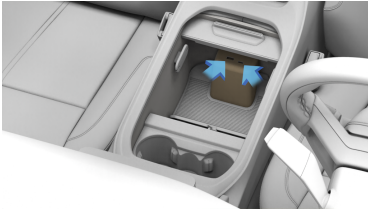

Insert the phone into the left clip with the back of the phone in contact with the side of the storage compartment to charge a mobile phone with wireless charging capability.

2. Two more USB-C ports can be found on the rear of the front center console.



**⚠ WARNING:** Remove all objects from the charger before charging your compatible smartphone. Objects, such as coins, keys, rings, paper clips, or cards, between the smartphone and charger may become very hot. On the rare occasion that the charging system does not detect an object, and that object becomes wedged between the smartphone and charger, remove the phone and allow the object to cool before removing it from the charger, to prevent burns.

**✎ Note:** Do not connect multiple devices to the USB ports using a USB hub. This may overload the USB charging circuit and prevent some devices from charging.

## Wireless Charging

---

A wireless charging pad is located in the center console storage compartment.

**⚠ CAUTION:** If objects in the vehicle interior are stored incorrectly, they can slide or be thrown around and hit vehicle occupants. There is a risk of injury, in the event of sudden braking or sudden change in direction of the vehicle.

- Always secure objects to prevent the objects in these types of events.
- Always make sure the objects do not protrude from storage spaces.
- Close lockable storage spaces before driving.
- Always secure heavy, hard, pointed, sharp-edged, fragile or bulky objects in the load compartment.

The operating temperature for the wireless charger is  $-40\text{ }^{\circ}\text{C}$  ( $-40\text{ }^{\circ}\text{F}$ ) to  $60\text{ }^{\circ}\text{C}$  ( $140\text{ }^{\circ}\text{F}$ ).

**FCC Notes**

This device complies with part 15 of the FCC Rules. Operation is subject to the following two conditions: (1) This device may not cause harmful interference, and (2) this device must accept any interference received, including interference that may cause undesired operation.

Changes or modifications not expressly approved by the party responsible for compliance could void the user's authority to operate the equipment.

This equipment has been tested and found to comply with the limits for a Class B digital device, pursuant to part 15 of the FCC Rules. These limits are designed to provide reasonable protection against harmful interference in a residential installation. This equipment generates, uses and can radiate radio frequency energy and, if not installed and used in accordance with the instructions, may cause harmful

interference to radio communications. However, there is no guarantee that interference will not occur in a particular installation. If this equipment does cause harmful interference to radio or television reception, which can be determined by turning the equipment off and on, the user is encouraged to try to correct the interference by one or more of the following measures:

- Reorient or relocate the receiving antenna.
- Increase the separation between the equipment and receiver.
- Connect the equipment into an outlet on a circuit different from that to which the receiver is connected.
- Consult the dealer or an experienced radio/TV technician for help.

**12-Volt Power Socket**

**⚠ WARNING:** Close the cover when it is not in use. If this outlet is mishandled, it may cause an electric shock.

**⚠ CAUTION:** The 12-volt power socket should not be used with a cigarette lighter. Lighters could potentially cause heat damage to the socket.

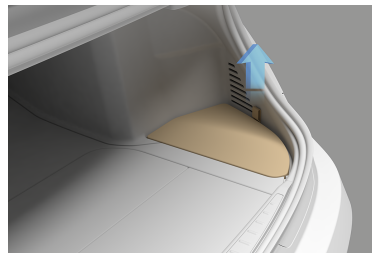

A 12-volt power socket is located in the trunk and can be accessed by removing the RH floor panel.



The power socket is primarily provided for use with the tire repair kit, but can also be used for other accessories requiring up to 15A or a maximum of 180 watts.

06

# DreamDrive

---

# About DreamDrive

## DreamDrive Features

---

Your **Lucid Air** is equipped with an Advanced Driver Assistance System (ADAS) called "**Lucid DreamDrive**." The following features are available:

 Note: DreamDrive features are not available when Driving Mode is set to *Track*.

### Driving Experience

- Adaptive Cruise Control
- High Beam Assist
- Traffic Sign Recognition
- Traffic Drive-Off Alert
- Drowsy Driver Alert
- Distracted Driver Alert
- Highway Assist (PRO)

### Supplemental Safety

- Forward Collision Warning
- Automatic Emergency Braking
- Cross Traffic Protection
- Lane Departure Protection
- Blind Spot Warning
- Blind Spot Display (PRO)

### Parking Experience

- Automatic Park In
- Automatic Park Out
- Rear View Monitoring
- Park Distance Warning

- Surround View Monitoring (PRO)

 Note: (PRO) These features are available only with DreamDrive Pro and in certain regions.

The DreamDrive features are configured using the Pilot Panel. To find out more about each feature, press the 'i' icon next to the feature.

These features are designed to increase vehicle safety and improve driving behavior. You can enable or disable most features individually and (in some cases) adjust operating parameters.

### Driver Responsibility

DreamDrive systems are designed for comfort, convenience, and to enhance safety. However, **these systems are NOT replacements for attentive, responsible driving.**

 **WARNING:** You are responsible for the vehicle's safe operation as its driver. You must be observant and address any warnings and indications of unsafe conditions caused by the vehicle, or external factors.

Brake or steering interventions only occur within defined limits, and may not have time to slow or correct the vehicle enough so it avoids a collision. **Your complete attention is still required while driving, and you should always be ready to steer the vehicle and apply the brakes when necessary.**



DreamDrive Component Locations

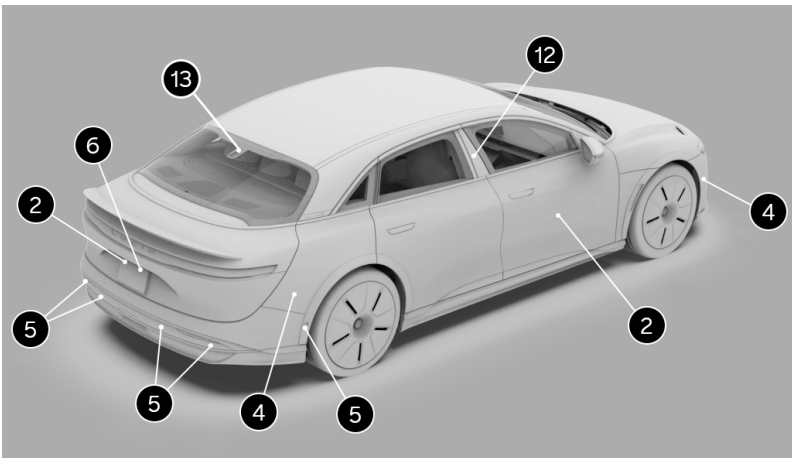
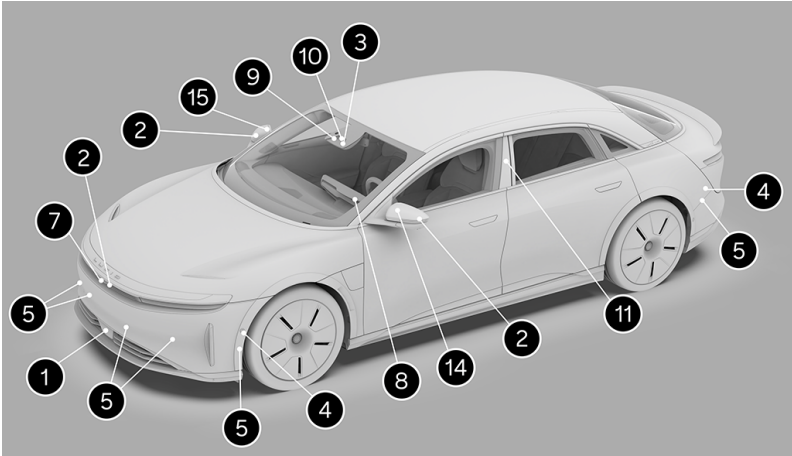

1. Long-Range Radar
2. Surround View Monitoring Cameras, see Surround View Monitoring.
3. Front Multifunction Camera
4. Short-Range Radar
5. Ultrasonic Sensors
6. Rear Multifunction Camera, see Rear View Monitoring.

- 
7. LiDAR
  8. Driver Monitoring Camera
  9. Front Narrow Angle Camera
  10. Front Wide Angle Camera - Center
  11. Front Wide Angle Camera - Left
  12. Front Wide Angle Camera - Right
  13. Rear Narrow Angle Camera - Center
  14. Rear Narrow Angle Camera - Left
  15. Rear Narrow Angle Camera - Right

- ⚠ WARNING:** The following does not include all of the situations that may interfere with the proper operation of DreamDrive components. Never rely on these components to keep you or your occupants safe. It is the driver's responsibility to remain alert and drive safely and responsibly at all times.
- ⚠ CAUTION:** **Lucid** strongly recommends always having your vehicle serviced at a **Lucid Service Center** to ensure that all of the vehicle's DreamDrive components are properly handled. Failure to do so can cause one or more DreamDrive features to malfunction.
- ⚠ CAUTION:** Contact a **Lucid Service Center** if a fault occurs with any of the DreamDrive features.

There are numerous factors that can impact the performance of the DreamDrive components, impacting their ability to function as intended. These factors include (but are not limited to):

- Poor sensor visibility due to weather conditions (such as heavy rain, snow, or fog)
- Bright ambient light (such as oncoming headlights or direct sunlight)
- Poor ambient light (such as at night or in poorly-lit tunnels)
- Dirty, foggy, damaged, or otherwise obscured sensors, cameras, or camera view areas of the Glass Canopy
- Interference or obstruction by an object mounted onto the vehicle (such as a bike rack)

- Obstruction caused by applying excessive paint or adhesive products (such as wraps, stickers, or rubber coatings) onto the vehicle
- Narrow or winding roads
- A damaged or misaligned bumper
- Interference from other equipment that generates ultrasonic waves
- Extremely hot or cold temperatures
- Partially or completely disabled Lucid Stability Control
- Selecting **Sprint** drive mode

**Sensor and Camera Failure**



- ⚠ CAUTION:** If blockage occurs with a DreamDrive sensor, attempt to clear the blockage. Remove any objects or debris that may be obstructing the component by following specific cleaning instructions. Contact a **Lucid Service Center** if the warning message persists. Furthermore, if something other than a blockage (that you cannot remedy) occurs and a sensor or camera failure occurs, contact a **Lucid Service Center**.



A warning with the location of the blocked component will display on the Glass Cockpit if the system detects a blocked sensor or camera.

When a DreamDrive component is blocked or faulty, any related features

---



will be unavailable or have a degraded performance. Any relevant settings will be grayed out with a warning message displayed on the Pilot Panel under  >  **DreamDrive**.

# Driving Experience

## Steering Wheel DreamDrive Controls



1. Left-side Toggle Switch
2. DreamDrive Activate
3. Gap Setting Adjustment
4. Cancel Drive Assist Control

- Press  to access or exit **DreamDrive**.
- Press and hold the button to switch between Adaptive Cruise Control and Highway Assist systems (see Adaptive Cruise Control and Highway Assist for more information).
- Press the toggle button to engage the feature.
- Push the toggle up/down to adjust the set speed by  $\pm 1$  increment.  
  
Push and hold the toggle up/down to adjust the set speed by  $\pm 5$  increments.
- Press  to adjust the gap setting.
- Press  to cancel Adaptive Cruise Control or Highway Assist.

#### DreamDrive Requirements

---

Adaptive Cruise Control or Highway Assist can be activated when all of the following conditions are met:

- Driver's Seat Belt is Buckled
- All Doors are Closed
- Vehicle is in **D** (Drive)
- Brake Pedal is Released
- Current Speed is at Least 20 mph (30 kmph)

Adaptive Cruise Control and Highway Assist will automatically disengage and sound an audible alert in any of the following situations:

- Brake Pedal is Pressed
- Driver's Seat Belt is Unbuckled
- Trunk, the Hood, or a Door is Open







- Gear is Shifted Out of **D** (Drive)
- Parking Brake is Applied, (See Parking Brake)
- Vehicle Speed Goes Above the Maximum Threshold of 90 mph (150 kmph)
- Tires Lose Traction
- Automatic Emergency Braking is Activated, (See Automatic Emergency Braking)
- System Feature Fails, such as a Powertrain or Sensor Failure
- Front Camera is Blocked
  -  **Note:** Try activating the wipers if the system notes that the front camera is blocked. See Wipers.
- Brake Temperature is Too High

Adaptive Cruise Control and Highway Assist systems, even under optimal conditions, are not a substitute for safe driving. See DreamDrive Limitations for details.

#### Adaptive Cruise Control

---

 **WARNING:** Adaptive Cruise Control is designed for your driving comfort and convenience and is not a collision warning or avoidance system. It is your responsibility to stay alert, drive safely, and be in control of the vehicle at all times. Never depend on Adaptive Cruise Control to adequately slow down the vehicle. Watch the road in front of you and be prepared to take corrective action at all times. Failure to do so can result in serious injury or death.

-  **WARNING:** Never depend on Adaptive Cruise Control to brake for pedestrians, animals, or other objects. Always watch the road and be prepared to take corrective action. Failure to do so can result in serious injury or death.
-  **WARNING:** Do not use Adaptive Cruise Control on city streets or on roads where traffic conditions are constantly changing.
-  **WARNING:** Adaptive Cruise Control may not detect or brake for narrow vehicles, such as bicycles or motorcycles.
-  **WARNING:** Adaptive Cruise Control may not detect stationary or slow-moving vehicles below 6 mph (10 kmph).
-  **WARNING:** Do not use Adaptive Cruise Control on winding roads with sharp curves, on icy or slippery road surfaces, or when weather conditions (e.g., heavy rain, snow, or fog), make it inappropriate to drive at a consistent speed. Adaptive Cruise Control does not adapt driving speed based on road and driving conditions.
-  **WARNING:** Temporarily turn off Adaptive Cruise Control when driving in areas where you must reduce speed (e.g., turn lanes, entering and exiting highways, or construction zones). This prevents the vehicle from accelerating to the stored speed in such situations.

When engaged, Adaptive Cruise Control uses data from the vehicle's exterior sensors to automatically adjust your cruising speed, maintaining a safe distance from any vehicles ahead. The default distance maintained is the furthest allowed. See Adjusting Following Distance on page 116.

Adaptive Cruise Control is primarily intended for driving on dry, straight roads



with no stops or sharp curves, such as highways and freeways.

Adaptive Cruise Control will issue a takeover request if it cannot safely brake the vehicle.

 **Note:** The Adaptive Cruise Control system will disengage and apply the Emergency Parking Brake (EPB) if your vehicle stops behind another vehicle and remains stationary for more than 10 minutes.

### Setting and Changing Cruising Speed

Press the  DreamDrive button on the steering wheel to activate Adaptive Cruise Control. See Steering Wheel DreamDrive Controls.

 **Note:** DreamDrive Mode will default to Highway Assist for first-time users. When a user profile is active, the system will go to the last used DreamDrive Mode, (Adaptive Cruise Control or Highway Assist). If Highway Assist is activated, press and hold the  DreamDrive button to switch to Adaptive Cruise Control.

To set the cruising speed:

- Push the left toggle up or down to adjust the speed by  $\pm 1$  increment.
- Push and hold the left toggle up or down to adjust the set speed by  $\pm 5$  increments.

**Minimum speed:** 20 mph (30 kmph)

**Maximum speed:** 90 mph (150 kmph)

The cruising speed displays to the right of the speedometer on the Glass Cockpit and is highlighted when Adaptive Cruise Control is active. Cruising speed can be changed using the same controls once activated.

---

## Cruising Speed

-  **WARNING:** Occasionally, Adaptive Cruise Control may brake late or unexpectedly due to following a vehicle too closely, or if detection issues occur due to road infrastructure, (e.g., curves, bridges, or tunnels). The driver is responsible for watching the road, controlling the vehicle, and intervening if required, at all times.

Adaptive Cruise Control maintains your selected cruising speed when a vehicle is not detected in front of you.

When cruising behind a detected vehicle, (highlighted in the Center Cockpit Panel), Adaptive Cruise Control will accelerate and decelerate the vehicle, as needed, to maintain the set following distance up to the set speed. See Adjusting Following Distance on page 116.

### Adopting New Speed Limits

Cruise Speed Update will prompt you on the Glass Cockpit when a new speed limit is detected. Press the left toggle button on the steering wheel to update the cruising speed to the new speed limit.

If you do not wish to update the cruising speed, the prompt will disappear after 7 seconds.

-  **Note:** You can disable the option of receiving speed limit change prompts from Cruise Speed Update.

### Driver Override

You can temporarily override the set speed using the accelerator pedal while Adaptive Cruise Control is active. Adaptive Cruise Control will disengage if it is overridden for more than 60 seconds.

The Center Cockpit Panel will display the following when you press the accelerator pedal:

- The **ADAPTIVE CRUISE display will change to OVERRIDE.**
- The lane display will no longer be highlighted, despite usually being highlighted when Adaptive Cruise Control is active.
- The target vehicle will not be highlighted.



Once the accelerator is released, Adaptive Cruise Control should automatically resume and return to the cruise speed set by the driver. The Glass Cockpit displays the active Adaptive Cruise Control mode.

-  **WARNING:** Adaptive Cruise Control will not apply the brakes to maintain the set following distance from a vehicle ahead during Driver Override.

### Adjusting Following Distance

-  **WARNING:** It is your responsibility as the driver to determine and maintain a safe following distance at all times. Do not rely on Adaptive Cruise Control to maintain an accurate or appropriate following distance.

-  **WARNING:** Never depend on Adaptive Cruise Control to adequately slow down the vehicle to avoid a collision. Always watch the road in front of you and be prepared to take corrective action at all times. Failure to do so can result in a collision with the risk of serious injury or death.

To adjust the vehicle's time gap settings from the vehicle ahead, press the  button on the steering wheel. See Steering Wheel DreamDrive Controls. There are four time gap settings to select from, which will cycle as the  button is pressed.



The change in the time gap settings displays on the Center Cockpit Panel.

### Cancel and Resume Cruise Control

To cancel Adaptive Cruise Control, press the  Cancel button on the steering wheel. See Steering Wheel DreamDrive Controls for more information.

Press the brake pedal, if it is safe to do so in the current traffic conditions, to cancel the system.

After Adaptive Cruise Control has been canceled, you can resume the previously set speed by toggling up the left steering wheel control.

### Highway Assist

#### Highway Assist Overview

Highway Assist is a **DreamDrive Pro** feature that detects lane markings to actively steer and center your vehicle in the lane. It detects the presence of other vehicles in your lane and adjusts your speed to help you maintain a safe following distance.

 **WARNING:** Highway Assist is designed for your driving comfort and convenience. Highway Assist is not a collision warning or avoidance system. It is your responsibility to stay alert, drive safely, and be in control of the vehicle at all times.

 **WARNING:** Never depend on Highway Assist to assume control of your vehicle. Always keep your hands on the steering wheel, watch the road in front of you, and be prepared to take corrective action. Failure to do so can result in serious injury or death.

 **WARNING:** A warning will display if Highway Assist reaches its limits. Always keep your hands on the steering wheel, watch the road in front of you, and be prepared to take corrective action. Failure to do so can result in serious injury or death.

 **WARNING:** Detection of lane markings and objects may malfunction, causing Highway Assist to make unexpected steering interventions. If this happens, you are responsible for steering the vehicle to conform to traffic conditions.

 **WARNING:** Turn off Highway Assist when driving in areas where the lane markings are not clear or unavailable (such as construction zones, newly paved roads without markers, etc.). This prevents the vehicle from maneuvering erratically in such situations.



 **WARNING:** Highway Assist may not be available in regions where the vehicle has no network coverage or if the system loses network reception.

 **CAUTION:** Some roads may contain sections with tight curves exceeding the steering capabilities of Highway Assist. In these sections, you will receive an alert that assisted steering is limited or unavailable.

Highway Assist is only available on some roads. If you activate Highway Assist and then drive onto a road that Highway Assist does not support, the system will deactivate Highway Assist and switch back to Adaptive Cruise Control.

#### Activating Highway Assist

To activate Highway Assist, press the  DreamDrive button on the steering wheel, followed by the toggle button to set the desired cruise speed. See DreamDrive Controls appear at the top of the center Cockpit Panel.

 Note: DreamDrive Mode defaults to Highway Assist for first-time users. The system will go to the last used DreamDrive Mode, Adaptive Cruise Control, or Highway Assist, when a user profile is active. If Adaptive Cruise Control is activated and implemented on a road that supports Highway Assist, press and hold the  DreamDrive button to switch to Highway Assist.

You will hear a chime, the lane will be highlighted, and the words Highway Assist will display on the Center Cockpit Panel when Highway Assist is activated.

 Note: When Highway Assist has been temporarily overridden, this indicator and lane highlighting will gray out, and the text will change to **Override**.

### Traffic Jam Assist

Highway Assist will follow the leading vehicle when the system cannot detect the lane lines or lane markings and there is a vehicle ahead.

 Note: Traffic Jam Assist is only available when the vehicle's speed is under 43 mph (70 kmph). The system will prioritize using the lanes over following a leading vehicle when lanes are detected.

 **WARNING:** If there are no lanes detected and Traffic Jam Assist is following a leading vehicle, your vehicle may pursue the vehicle into another lane. Therefore, it is your responsibility to stay aware of your surroundings and be prepared to take corrective action at all times.

### Cooperative Lane Change

To change lanes without disengaging or deactivating Highway Assist, activate the turn signal in the direction you will

be changing lanes. See Turn Signals on page 85.

Activating the turn signals and turning the steering wheel will temporarily override the Highway Assist feature. The effort needed to override the lane centering system will be reduced in the direction of the intended lane change, allowing you to manually complete the lane change with ease. Highway Assist will automatically resume when the vehicle is centered in the new lane and both lane lines are detected.

### Manual Lane Biasing

Manual Lane Biasing temporarily allows a you to manually adjust the vehicle's position within a lane while Highway Assist is still engaged and actively controlling the vehicle.

 Note: The system will go to an override state if you apply excessive steering force to maneuver the vehicle outside a lane, or if the vehicle crosses a lane.

### Hands-Off Detection and In-Lane Stops

Although Highway Assist helps you with steering, it is necessary to keep your hands on the wheel and pay attention to the road at all times. The system will provide a series of warnings if it detects that you are distracted and your hands are not on the steering wheel. If the warnings remain unattended to, the system will lead you to an in-lane stop. Refer to the following information for details on the warning prompts:

A prompt will display on the center Glass Cockpit if Highway Assist detects that you are distracted, not looking forward, or your hands are not on the steering wheel for more than 6 seconds,

A warning will display on the Glass Cockpit if no steering wheel input has been detected for 15 seconds, prompting you to place your hands on the steering wheel.

If steering wheel input still has not been detected after an additional 15 seconds:

- An elevated warning will appear on the Glass Cockpit, prompting you to put your hands on the steering wheel.
- An alert will sound.
- You will receive feedback through the brake pedal before in-lane stop deceleration begins.

The final stage of in-lane stop initiation depends on the current speed of the vehicle, and will occur any time after 33 seconds of continuous, non-existent steering wheel input:

- The vehicle will gradually slow, depending on the current speed.
- Hazard lights will activate.
- A flashing red animation will appear on the center Glass Cockpit.
- Audible warnings will sound.

 *Note:* If you provide steering wheel input, or presses either the brake or accelerator during an in-lane stop, the system will cancel the in-lane stop. If the vehicle has already started to slow down, Adaptive Cruise Control and Highway Assist will be unavailable until the next drive cycle.

Once an in-lane stop has completed:

- The vehicle will automatically shift into **P** (Park).
- Highway Assist will get canceled.
- DreamDrive will be unavailable until the next drive cycle.
- All doors will unlock.
- An audible alert will sound.

 *Note:* Warnings will be dismissed if the vehicle is shifted out of **P** (Park). See Using the Drive Selector on page 78 for more information.

 **WARNING:** An in-lane stop is illegal in many areas. It is only an emergency procedure and should not be misused. Do not deliberately initiate an in-lane stop as a means to stop the vehicle.

 **WARNING:** An in-lane stop is meant to reduce the hazard of a moving vehicle that is not being consistently controlled by the driver. However, a vehicle stopped in traffic can also be a hazard.

### Steering Override

You can temporarily override Highway Assist is active by turning the steering wheel. The Highway Assist indicator will gray out on the Glass Cockpit when you use the steering wheel.

Once the steering wheel returns to its neutral position, the vehicle is centered in the lane, and the system detects lanes again, Highway Assist will automatically resume and the Glass Cockpit will return to displaying the active Highway Assist mode.

### Manually Canceling Highway Assist

To cancel Highway Assist, press the

 Cancel button on the steering wheel. See Steering Wheel DreamDrive Controls on page 113.

Highway Assist can also be canceled by pressing the brake pedal if it is safe to do so in the current traffic conditions.

### Traffic Sign Recognition

The Traffic Sign Recognition system uses the front cameras and navigation system data to recognize traffic signs on the road, therefore providing you with driving

---

information, such as speed limits and other regulations.

Traffic signs will display on the Glass Cockpit next to the speedometer when they are detected.

 **WARNING:** Traffic Sign Recognition is only an assist feature. The driver is responsible for paying attention to the road signs and determining the appropriate speed limit, road conditions, and driving speed.

 **WARNING:** Traffic Sign Recognition is not available in all countries.

 **WARNING:** Map data is not always accurate. The GPS can miscalculate the vehicle location and provide an incorrect traffic sign.

 **WARNING:** The Traffic Sign Recognition system will not be fully functional and may provide inaccurate information if a road or traffic sign has recently been changed.

 **WARNING:** The Traffic Sign Recognition system will not display correct information and warnings won't take effect if it is unable to determine a traffic sign or is uncertain whether an acquired speed limit is accurate or not.

## Speed Limit Alerts

The display color of the speed limit sign will change color and may increase in size when Speed Limit Alert is enabled, (see Speed Limit Alert Settings), and if the current vehicle speed exceeds the detected speed limit. The display will return to its normal color and size when the vehicle is slowed down to within the speed limit.

## Wrong-Way Warnings

The system will alert you with an audible alert and a notification on the Glass

Cockpit if a Wrong Way road sign is detected and the vehicle passes it.

## Speed Limit Alert Settings

To configure Speed Limit Alert settings, use the Pilot Panel and touch  >

 **DreamDrive.**

- Touch to enable or disable **Speed Limit Alert**. Additional options to receive **VISUAL** or **VISUAL AND AUDIO** alerts are available when this feature is enabled.
- Touch to enable or disable **Cruise Speed Update**. This feature will notify you when a new speed limit is detected and prompts you with an option to update your cruising speed when Adaptive Cruise Control is active. It is the driver's responsibility to determine the appropriate speed limit, road conditions, and driving speed.

 **Note:** The detected speed limit will still be displayed next to the set cruise speed on the Glass Cockpit when this feature is disabled.

---

## Traffic Drive-Off Alert

When your vehicle comes to a stop behind traffic, or another stopped vehicle, the Traffic Drive-Off Alert system will monitor the driver and alert them if they are distracted when the front vehicle pulls away from a stopped position.

The system will provide audible and visual alerts if a stopped vehicle in front pulls away and the interior camera detects that you are not facing forward.

 **Note:** You will not receive Traffic Drive-Off Alerts if the interior camera detects that you are already facing forward.



When Adaptive Cruise Control is active (see Adaptive Cruise Control on page

114), and the vehicle is stopped, you will receive a prompt on the Glass Cockpit once the traffic ahead clears. You can resume cruising speed by pressing the accelerator or by pushing up on the left steering wheel toggle (see Steering Wheel DreamDrive Controls on page 113).

The prompt will change and the system will sound an audible alert if you do not react to the initial prompt within a few seconds and if the driver is distracted.

- ⚠ **WARNING:** Never assume it is safe or legal to proceed when the Traffic Drive-Off Alert activates. Always check your surroundings first.

### Traffic Drive-Off Alert Settings

Use the Pilot Panel and touch  >  **DreamDrive**, then press to enable or disable **Traffic Drive-Off Alert** to configure Traffic Drive-Off Alert settings.

-  **Note:** The Traffic Drive-Off Alert setting will be saved to the current active user profile and not reset at each drive cycle.

### Distracted Driver Alert

When enabled, the Distracted Driver Alert system will monitor the driver via the interior camera and issue alerts when it detects that the driver's eyes are not on the road.

-  **Note:** In some circumstances, the interior camera might be blocked. In this case, both the distracted driver and drowsy driver alerts will be unavailable. In this case, an alert will appear on the Center Cockpit Panel. When the obstruction is removed, the driver will be notified.



-  **Note:** The Distracted Driver Alert is not available when the vehicle's speed is below 25 mph (40 kmph).

If the system detects that the driver's eyes are off the road for two seconds, an alert will display on the Glass Cockpit and a chime will sound.

If the system detects that the driver has their eyes off the road for an additional three-to-five seconds, a warning will display on the Glass Cockpit. A chime will sound and a haptic pulse will vibrate the steering wheel to alert the driver.

- ⚠ **WARNING:** Do not rely on the Distracted Driver Alert to maintain your focus on the road. The driver is responsible for paying attention at all times while operating the vehicle.

### Distracted Driver Alert Settings

To configure Distracted Driver Alert settings, on the Pilot Panel, touch  >  **DreamDrive**, then enable or disable **Distraction Alert**.

The Distraction Driver Alert settings will then save to the current user profile.

### Interior Camera

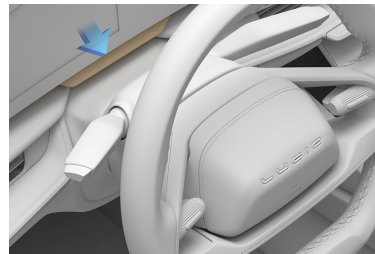

Driver Awareness Monitoring camera is located on the dashboard directly behind the steering wheel.

-  **Note:** If the steering column is not positioned properly, the DMS Camera might get blocked and Driver Monitoring warning will be unavailable.

When enabled, the Drowsy Driver Alert system will issue alerts once it detects early signs of drowsiness. This system will monitor for the following signs:

- Frequent Driver Eye Closure, detected via the Interior Camera
- Erratic Driving Behavior, such as Swerving

 **Note:** Drowsy Driver Alert is not available when the vehicle's speed is below 25 mph (40 kmph).



A notification will appear on the Center Cockpit Panel if the system detects signs of driver drowsiness.



An indicator will display on the Glass Cockpit when the Drowsy Driver Alert activates until the vehicle has been stopped or shifted out of **D** (Drive).

In addition to the alert, the Right Cockpit Panel will display a list of nearby break areas, when available. If desired, press a location to add a waypoint to your current trip and navigate it to that break area. See Navigating.

A warning notification will appear on the Glass Cockpit and an audible alert will sound if the system detects continued signs of drowsiness after the first alert.

When available, the Right Cockpit Panel will also display a list of nearby break areas. Press **SHOW ME** to view the list or **DISMISS** to clear.

A new warning notification will appear along with a louder audible alert and haptic vibration of the steering wheel

if the system still detects signs of drowsiness after the second alert.



Hazard lights will also activate and the Right Cockpit Panel will, again, display a list of nearby break areas.

Responses include:

- Pressing a Selection in the Prompt on the Right Cockpit Panel
- Double-Clicking the Hazard Light Button
- Stopping the Vehicle
- Shifting out of **D** (Drive)

 **WARNING:** Do not rely on the Drowsy Driver Alert to warn you when you are not focusing on the road or driving erratically. Drive to a safe area and park when you are unable to focus on driving.

## Drowsy Driver Alert Settings

Click  >  **DreamDrive** on the Pilot Panel, then press to enable or disable **Drowsy Driver Alert**.

Drowsy Driver settings will then save to the current User Profile.

## High Beam Assist

 **WARNING:** High Beam Assist is an aid for selecting the best possible lighting based on prevailing conditions. The driver is always responsible for manually switching between high and low beam depending on the traffic situation or weather condition.

High Beam Assist (HBA) is a feature that uses the vehicle's cameras to detect the headlights of approaching vehicles or the taillights of the vehicle directly ahead.

The vehicle's headlight's will automatically switch from high beams

to low beams when either of these conditions are detected.

The headlights will return to high beams when the camera sensor no longer detects an approaching vehicle or a vehicle ahead.

 *Note:* The feature may automatically switch to low beams when street lighting is detected.

 *Note:* This feature will only operate in dark conditions when the vehicle's speed is greater than 18 mph (30 kmph).

### Activating High Beam Assist

1. Make sure the feature is enabled via the DreamDrive settings.
2. Put the light settings in Auto Mode.
3. Push the left steering column lever away from yourself to turn on the high beams.



The High Beam Assist indicator is displayed on the instrument cluster whenever the system is **activated**.

To override High Beam Assist:



1. If HBA is in low or high beam and the driver wants continuous high beam, push the left steering column lever.
2. If HBA is in high beam and the driver wants continuous low beam, pull the left steering column lever. Push the left steering column lever to return to HBA after an override.

See High Beam Headlights on page 85 for more information on continuous high beam or flashing the high beams while HBA is on.



An indicator will display on the Instrument Cluster, and High Beam Assist will be unavailable if the system detects a fault. Headlight high beams

can still be operated using the left steering column lever.

High Beam Assist can be enabled or disabled using the Pilot Panel. Select  >  Vehicle > Drive Settings, then press to enable or disable High Beam Assist.

### Reduced High Beam Sensitivity

If High Beam Assist is enabled and the vehicle is parked, tapping and holding the High Beam Assist label in the Pilot Panel for 30 seconds will reveal the Reduced High Beam Sensitivity option.

 *Note:* This option will not appear if the vehicle is not in Park and will disappear automatically if it is in motion.

 **WARNING:** Reduced high beam sensitivity may result in the blinding of oncoming traffic. Do not use this mode.

---

# Collision Detection and Protection

## Collision Protection



---

Collision Protection includes Automatic Emergency Braking, Forward Collision Warning, and Rear Pedestrian Collision Protection. See Automatic Emergency Braking on page 124, Forward Collision Warning on page 125, and Rear Pedestrian Collision Protection on page 126.

Collision Protection is always enabled when you start the vehicle.

### Collision Protection Settings

-  **WARNING:** Lucid strongly recommends that you leave this feature enabled to provide potential supplemental assistance and help avoid serious injury.

Touch the  >  **DreamDrive** on the Pilot Panel, followed by enable or disable **Collision Protection**.

- You can select the level of sensitivity for Forward Collision Warnings: **EARLY**, **NORMAL** (default), or **LATE** when Collision Protection is enabled.

 **Note:** Sensitivity levels do not affect the actual braking distance.

 **Note:** The selected sensitivity level will be saved to the current user profile.

- You will be prompted to confirm your selection if you disable **Collision Protection**.



An indicator will display on the Glass Cockpit when Collision Protection is disabled.

## Automatic Emergency Braking

---

Working in conjunction with Forward Collision Warning, the Automatic Emergency Braking system detects the presence of an object such as a vehicle, bicycle, or pedestrian. The system will initiate emergency braking to reduce the severity of impact if it determines an imminent collision with an object to the front.

Furthermore, the system will provide additional brake support if the driver presses the brake during an Automatic Emergency Braking event.

An audible warning will sound and a visual warning will appear on the Glass Cockpit when Automatic Emergency Braking applies the brakes. You may also notice movement of the brake pedal.

 **Note:** If active, the Adaptive Cruise Control and Highway Assist systems will automatically deactivate if an Automatic Emergency Braking event is triggered. See Adaptive Cruise Control and Highway Assist.



 **Note:** Automatic Emergency Braking will not apply the brakes or stop applying the brakes when:

- The steering wheel is turned abruptly.
- The brake pedal is pressed and released while Automatic Emergency Braking is applying the brakes.
- The accelerator is pressed abruptly while Automatic Emergency Braking is applying the brakes.
- A hazard (vehicle, motorcycle, bicycle, or pedestrian) is no longer detected in the vehicle path.

 **Note:** Automatic Emergency Braking can be adversely affected by the limitations of Advanced Driver Assistance components. See DreamDrive Limitations. Use appropriate caution when driving.



A warning message and indicator will display on the Glass Cockpit if Automatic Emergency Braking is unavailable. Contact a Lucid Service Center if either of these items appear.

 **WARNING:** Automatic Emergency Braking is designed to minimize the impact of a frontal collision by attempting to reduce your driving speed, not to prevent a collision. Depending solely on Automatic Emergency Braking to avoid a collision can result in serious injury or death.

 **WARNING:** Automatic Emergency Braking only applies the brakes and does not steer the vehicle out of the path of the hazard.

 **WARNING:** There are factors that affect the performance of Automatic Emergency Braking, causing either no braking

or inappropriate or untimely braking. It is your responsibility to drive safely and remain in control of the vehicle at all times. Never depend on Automatic Emergency Braking to avoid or reduce the impact of a collision.

 **WARNING:** The brake pedal moves downward abruptly during Automatic Emergency Braking events. Always ensure that the brake pedal can move freely. Do not place material (including additional mats), under or on top of the vehicle-supplied floor mat. Always ensure that the driver's floor mat is properly secured. Failure to do so will impede the ability of the brake pedal to move freely.

### Speed Limitations

 **WARNING:** The Automatic Emergency Braking system will automatically cease when you manually disable Lucid Stability Control.

The Automatic Emergency Braking system, including Forward Collision Warning, is active at speeds above approximately 6 mph (10 kmph) and up to 112 mph (180 kmph). Pedestrian detection and reaction to stationary vehicles is active at speeds up to 53 mph (85 kmph).

### Automatic Emergency Braking Settings

See Collision Protection on page 124.

#### Forward Collision Warning

The Forward Collision Warning system uses the front camera mounted behind the windshield and the radar sensor mounted behind the front bumper to detect the presence of an object (such as a vehicle, bicycle, or pedestrian).

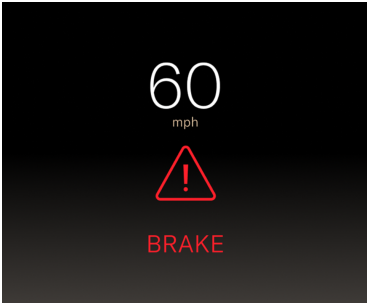

The system will sound an alert and prompt you to brake on the Center Cockpit Panel if it detects a collision that is likely to occur.

**TAKE IMMEDIATE CORRECTIVE ACTION if this happens**, and apply the brakes or steer clear of the impending collision.

 *Note:* The system will provide additional brake support if the driver presses the brake.

The Automatic Emergency Braking System will reduce speed if you do not react sufficiently to the warning. The warning is intended to help reduce the severity of a collision. See Automatic Emergency Braking.

The Glass Cockpit will flash red and an audible alert will sound when Automatic Emergency Braking is activated.

**TAKE IMMEDIATE CORRECTIVE ACTION if this happens.**

 **WARNING:** Forward Collision Warning is only an assist feature and is not a substitute for attentive driving and sound judgment. The driver is responsible for paying attention to the road, maintaining a suitable distance from the vehicle ahead, and braking or steering the vehicle, when necessary.

 **WARNING:** There are factors that reduce or impair the performance of the Forward Collision Warning

system, causing unnecessary, invalid, inaccurate, or missed warnings. Do not rely solely on Forward Collision Warning to warn you of a potential collision.

 **WARNING:** Forward Collision Warning only monitors what is in front of the vehicle. Be aware of your surroundings at all times while operating the vehicle.

 **WARNING:** Forward Collision Warning does not provide alerts when the driver is already applying the brake.

### Forward Collision Warning Settings

See Collision Protection on page 124.

#### Rear Pedestrian Collision Protection

Rear Pedestrian Collision Protection uses the rear camera to monitor for pedestrians behind the vehicle when the gear is in **N** (Neutral), **D** (Drive), or **R** (Reverse) and backward vehicle motion is detected. The system will issue a warning and apply the brakes if a collision is imminent. Note that Rear Pedestrian Collision Protection is active at speeds below 11 mph (18 kmph).



The system will sound an audible alert if it detects a rear collision with pedestrians that is likely to happen, and prompt you to brake on the Right Cockpit Panel. **TAKE IMMEDIATE CORRECTIVE ACTION if this happens.**

The emergency braking will activate if you do not react sufficiently to the warning to reduce the severity of the collision.

**⚠ WARNING:** Rear Pedestrian Collision Protection is only an assist feature and is not a substitute for attentive driving and sound judgment. The driver is responsible for paying attention while reversing, monitoring the surroundings, and braking or steering the vehicle, when necessary.

**⚠ WARNING:** There are factors that reduce or impair the performance of the Rear Pedestrian Collision Protection System, such as low ambient light conditions. This causes unnecessary, invalid, inaccurate, or missed warnings. Do not rely solely on Rear Pedestrian Collision Protection to warn you of a potential collision.

**⚠ WARNING:** Rear Pedestrian Collision Protection only monitors for pedestrians behind the vehicle. It does not detect objects and pedestrians outside of the range of the rear camera. Be aware of your surroundings at all times while operating the vehicle.

**⚠ WARNING:** Rear Pedestrian Collision Protection does not provide alerts when the driver is already applying the brake.

Cross Traffic Protection

Cross Traffic Protection warns the driver when there is a risk of collision with crossing traffic approaching from the left or right to the front or rear side of the vehicle. It will automatically apply the emergency braking if needed.

When enabled, Cross Traffic Protection is active at speeds below 10 mph (16 kmph) for warnings, and speeds below 6 mph (10 kmph) for braking.

*✎ Note:* Cross Traffic Protection is not available when the gear is in **P** (Park). Front cross traffic alerts or braking will not be issued if the vehicle speed exceeds 6 mph (10 kmph) or the driven distance

is over 131 ft (40 m) after shifting from **P** (Park) to **D** (Drive) gear.

Cross Traffic Protection will sound an alert and prompt on the Glass Cockpit when, the gear is in **D** (Drive) or **N** (Neutral), forward vehicle motion is detected and a collision risk is detected.

The system will activate emergency braking if the vehicle is moving and the driver does not react in time.

Cross Traffic Protection will sound an alert and prompt on the Right Cockpit Panel when the gear is in **R** (Reverse) or **N** (Neutral), backward vehicle motion is detected, and a collision risk is detected.



The system will activate emergency braking if the vehicle is moving and the driver does not react in time.

**⚠ WARNING:** Cross Traffic Protection is only an assist feature and not a substitute for attentive driving and sound judgment. The driver is responsible for paying attention while driving, monitoring the surroundings, and braking or steering the vehicle when necessary.



**⚠ WARNING:** There are factors that reduce or impair the performance of the Cross Traffic Protection system, causing unnecessary, invalid, inaccurate, or missed warnings. Do not rely solely on Cross Traffic Protection to warn you of a potential collision.

 **WARNING:** Cross Traffic Protection does not detect smaller objects outside of the range of the sensors. This can include (but is not limited to) small children or animals. Be aware of your surroundings at all times while operating the vehicle.

 **WARNING:** Cross Traffic Protection does not provide alerts when the driver is already applying the brake.

### Cross Traffic Protection Settings

 **WARNING:** Do not disable Cross Traffic Protection when driving. Disabling this feature deactivates alerts and emergency braking, which increases the risk of causing or contributing to a crash.

Touch   **DreamDrive** on the Pilot Panel, then press to enable or disable **Cross Traffic Protection** to configure Cross Traffic Protection. Settings will save to the current user profile.

#### Lane Departure Protection

---

Lane Departure Protection helps the driver prevent the vehicle from unintentionally straying out of a detected lane by providing steering correction with visual and haptic alerts.

Lane Departure Protection is available at vehicle speeds between 30-124 mph (50-200 kmph) for detecting lanes, and between 40-85 mph (60-140 kmph) for detecting road edges.

 **Note:** Lane Departure Protection is temporarily overridden when a turn signal is activated (see Turn Signals). Once you have steered into another lane and the turn signal automatically deactivates, Lane Departure Protection will resume if lane lines are detected.

When the system detects an unintentional drift toward the lane or road boundaries:

- An alert will display on the Glass Cockpit, highlighting the side the vehicle is drifting towards.
- If enabled, the steering wheel will provide a haptic vibration.
- Steering correction is applied to bring the vehicle back into the lane or road.

An audible alert will sound on the second correction if two or more steering corrections are detected within 180 seconds without the driver's hands on the steering wheel.

Audible alerts will be longer in duration for any consecutive steering corrections.



Lane Departure Protection alerts will be canceled immediately if any of the following actions occur:

- Activated Turn Signal
- Intentional Steering
- Intentional Acceleration
- Intentional Braking

 **WARNING:** Lane Departure Protection is for guidance purposes only and is not intended to replace your own direct visual checks. Never depend on Lane Departure Protection to inform you of unintentionally driving outside of the boundaries of the driving lane or road edge. Always stay alert, pay attention to the driving lane, and always be aware of other road users. Failure to do so can result in serious injury or death.

- ⚠ **WARNING:** Lane Departure Protection is designed to detect lane markings and certain road edges. It is your responsibility to drive attentively and stay within the boundaries of the driving lane.
- ⚠ **WARNING:** Any changes to the vehicle's suspension or wheel height may result in degraded feature performance or no activation.
- ⚠ **WARNING:** Excessive crosswinds, large road crown, improper tire pressures, or vehicle loading conditions can affect the feature's performance.

### Lane Departure Protection Settings

To configure Lane Departure Protection, touch  >  **DreamDrive** on the Pilot Panel, then enable or disable **Lane Departure Protection**. The settings are saved to the current user profile.

 An indicator will display on the Glass Cockpit when Lane Departure Protection is disabled or is unavailable.

When enabled, press **INTERVENTION** (default), or **WARNING** or **WARNING AND INTERVENTION**. The system will give you haptic feedback through the steering wheel, when you select **WARNING** or **WARNING AND INTERVENTION** and when it detects that you need to make a correction while driving.

Warnings automatically cancel when the risk of an unintentional lane departure has been reduced (such as when you steer the vehicle back to the current lane).

#### Blind Spot Warning

**Blind Spot Warning** will provide visual and audible warnings, if enabled, when the vehicle is in motion and the system detects an object in your blind spot or close to the side of your vehicle.

Warnings will automatically cancel when the risk of a collision is no longer present or a vehicle is no longer detected in the blind spot.



The amber LED in the mirror will illuminate depending on which side an object is detected in a blind spot.



 **Note:** The amber LED in the corresponding mirror will flash if the vehicle speed is above 6 mph (10 kmph) and a turn signal is activated in the direction of the object.

Visual and audible warnings will activate, (if enabled), when a turn signal is turned on in the direction of the object in a blind spot.

A camera view of that blind spot will also be displayed if Blind Spot Display is activated. See Blind Spot Display.

- ⚠ **WARNING: Blind Spot Warning** should not be used as a replacement for checking the interior and exterior mirrors or looking over your shoulder before changing lanes. It's the driver's obligation to stay alert, pay attention to traffic, and take action if necessary.
- ⚠ **WARNING: Blind Spot Warning** may not cover an extended blind spot zone when a trailer is attached to a detected vehicle.

### Blind Spot Warning Settings

Touch  >  **DreamDrive** on the Pilot Panel, followed by enable or disable **Blind Spot Warning** to configure Blind

---

Spot Warning. Settings will save to the current user profile.

Select whether you would like to receive **VISUAL** (default) or **VISUAL AND AUDIO** warnings once it is enabled. If it is disabled, visual and audible warnings on the Glass Cockpit will longer issued. Warnings via LED's on exterior rear view mirrors will still be provided.

#### Blind Spot Display

---



Blind Spot Display uses the exterior cameras to project an image of the blind spot field of view onto the Glass Cockpit when a turn signal is activated, helping the driver assess the surroundings. See Turn Signals.

 Note: Blind Spot Display is only available at speeds above 25 mph (40 kmph).

Activating a turn signal, (with Blind Spot Display enabled), will bring the camera view up for that side on the Center Cockpit Panel.

 **WARNING:** Blind Spot Display should not be used as a replacement for checking the interior and exterior mirrors or looking over your shoulder before changing lanes. It is the driver's obligation to stay alert, pay attention to traffic, and take action if necessary.

### Blind Spot Display Settings

Touch  >  **DreamDrive** on the Pilot Panel, then enable or disable **Blind Spot Display on the Glass Cockpit** to configure Blind Spot Display. Settings will save to the current user profile.





# Parking Experience

## About Parking Experience

-  **Note:** Automatic parking maneuvers are calibrated according to the tire size. The accuracy of these maneuvers and the overall performance of the parking experience depends on the vehicle knowing the installed tire size. Installing tires of different sizes without updating the tire size in the system will affect parking performance. Lucid strongly recommends changing your tires at a Lucid Service Center to ensure an optimal automatic parking experience. Failure to do so may cause degraded performance and potential damage to your vehicle or wheels.

## Automatic Park In



Automatic Park In takes control of shifting, accelerating, braking, and steering the vehicle into a parking space.

-  **Note:** The sensors only detect parking spaces that are bounded by a three-dimensional object on at least one side (such as an open space next to a vehicle or between two vehicles).
-  **Note:** Automatic Park In cannot detect or park in diagonal spaces.
-  **WARNING:** Automatic Park In does not consider objects located outside the range of sensors during the detection of parking spaces or calculating the parking path. Continually check your surroundings throughout the parking sequence. Be prepared to apply the brake and take control to avoid pedestrians, vehicles, or objects.
-  **WARNING:** It is the driver's responsibility to determine

whether it is safe and legal to park in a parking space detected by Automatic Park In.

## Using Automatic Park In

Press  on the Pilot Panel to activate Automatic Park In. The system will then search for parking spaces using the exterior sensors. Drive slowly forward to cause the system to scan the surroundings.

-  **Note:** The vehicle must be moving below approximately 15 mph (25 kmph) to scan. The system will prompt you visually and audibly to slow down if it is moving too fast.
-  **Note:** You must drive past a space before it can be fully detected.



Detected spaces will be displayed on the Pilot Panel and Glass Cockpit. An audible alert will sound for each one. If you wish to park in a detected space:

1. Bring the vehicle to a full stop.

2. Press and hold the brake pedal.
3. Press a space on the Pilot Panel to select it.

 Note: The system can detect up to four parking spaces at a time.

Release the brake pedal and steering wheel to begin parking when the system prompts you. An audible alert will sound when vehicle movement begins. The rear view camera will display on the Right Cockpit Panel during Automatic Park In.

The Pilot Panel will display parking in progress. Monitor your surroundings throughout the parking sequence and be prepared to take control of the vehicle at any time.

- Automatic Park In can be stopped at any time by pressing the brake pedal, and will resume automatically when the brake is released.
- The system will stop the vehicle and prompt you to brake if it detects an obstacle in the vehicle's trajectory. The **RESUME** button on the Pilot Panel will become available when the hazard has cleared. Press **RESUME** and release the brake to continue the parking sequence.

 **WARNING:** Automatic Park In does not guarantee braking for an obstacle. The driver is responsible for observing surroundings and braking as needed.

- Press **CANCEL** at any time to stop Automatic Park In. Be prepared to take control of the vehicle. See Automatic Park In on page 131.

 Note: An audible alert will sound when the vehicle switches gears.

The Pilot Panel will prompt when parking has completed and an audible alert will sound. The vehicle will automatically shift into P when parking has completed.

 Note: If the system detects a curb or slope, it will set the wheels, accordingly. To disable this feature, see Automatic Park In on page 131.

### Canceling Automatic Park In

During the automated parking sequence, Automatic Park In will be immediately canceled if any of the following incidents occur:

- System or Sensor Faults
- Driver Presses the Accelerator Pedal, Holds the Steering Wheel, or Shifts Gears
- Driver Unbuckles the Seat Belt
- Driver Presses **CANCEL** on the Pilot Panel
- The Trunk, the Hood, or a Door is Not Closed
- The Selected Parking Space is Found to be Too Small after Initial Scan
- System Cannot Park Safely After Eight Tries
- Road Slope or Grade is Too High
- Road is too Slippery or Provides Poor Tire Traction
- A Safety System Activates (such as Collision Protection or Automatic Emergency Braking; see Collision Detection and Protection on page 124)



The vehicle will stop, emit an audible alert, and prompt the driver to take control of the steering wheel and brake pedal when the system is canceled. The vehicle will automatically shift into **P** (Park) if there is no response from the driver after 30 seconds.

You must start over at the beginning of the process and scan for a space if





Automatic Park In cancels for any of the aforementioned reasons and you wish to use the system again.

### Automatic Park In Settings

Touch  >  **DreamDrive** on the Pilot Panel, then press to enable or disable **Auto Park Wheel Curb Assist** to configure Blind Spot Display. Settings will save to the current user profile.

### Automatic Park Out

Automatic Park Out takes control of shifting, accelerating, braking, and steering the vehicle, positioning it to pull straight out of a parallel parking space.

-  *Note:* Automatic Park Out is only used to help exit parallel parking spaces.
-  *Note:* Automatic Park Out can only be activated when the vehicle is in **P** (Park).
-  **WARNING:** Automatic Park Out does not consider objects located outside the range of sensors during the pull-out sequence, including oncoming traffic. Continually check your surroundings throughout the pull-out sequence, and be prepared to apply the brake and take control to avoid hazards.

### Using Automatic Park Out

To activate Automatic Park Out, press  on the Pilot Panel. Press and hold the brake pedal, then tap the direction to pull out. Keep holding the brake pedal while the vehicle scans the available space.

-  *Note:* The **Automatic Park Out** display will vary depending on the DreamDrive package.

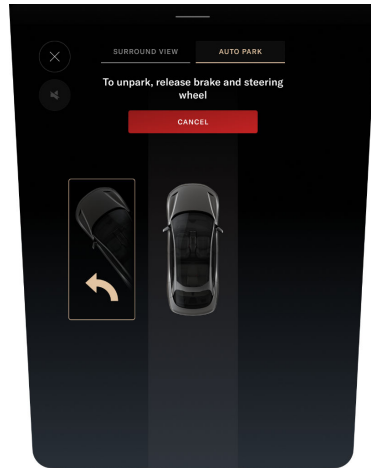

Release the brake and steering wheel to begin the pull-out sequence when the system prompts you.

An audible alert will sound when vehicle movement begins. A turn signal will activate in the direction you're turning out.

-  *Note:* The driver is still responsible to make sure the turn signal is in the correct direction.

The rear view camera will display on the Right Cockpit Panel during Automatic Park Out.

The Pilot Panel will display **Unpark in progress**. Monitor your surroundings throughout the sequence and be prepared to take control of the vehicle at any time.

- Automatic Park Out can be stopped at any time by pressing the brake pedal, and will resume automatically when the brake is released.
- The system will stop the vehicle and prompt you to brake if a system detects an obstacle in the vehicle's trajectory. The **RESUME** button on the Pilot Panel will

---

become available when the hazard has cleared. Press RESUME and release the brake to continue the parking sequence.

- Press **CANCEL** at any time to stop Automatic Park Out. Be prepared to take control of the vehicle. See Automatic Park Out on page 133.

 Note: An alert will sound when the vehicle switches drive modes.

When the system has completed the sequence:

- The gear will automatically shift into **D** (Drive).
- The system will hold the vehicle in place with the brake.
- The Pilot Panel will prompt you visually and audibly to take control of the vehicle.

The gear will automatically shift into **P** (Park) if there is no response from the driver after 20 seconds.

 Note: The Pilot Panel will alert you if Park Out direction is unavailable.

### Canceling Automatic Park Out

Automatic Park Out will be immediately canceled during the automated pull-out sequence, if any of the following incidents occur:

- System or Sensor Faults
- Driver Presses the Accelerator Pedal, Holds the Steering Wheel, or Shifts Gears
- Driver Presses **CANCEL** on the Pilot Panel
- Driver Unbuckles the Seat Belt
- The Trunk, the Hood, or a Door is not Closed

- The Selected Parking Space is Found to be too Small after Initial Scan
- System Cannot Park Safely After Eight Attempts
- Road Slope or Grade is Too High
- Road is too Slippery or Provides Poor Tire Traction
- A Safety System Activates (such as Collision Protection or Automatic Emergency Braking; see Collision Detection and Protection on page 124)

The vehicle will stop, emit an audible alert, and prompt the driver to take control of the steering wheel and brake pedal when the system is canceled. The gear will automatically shift into **P** (Park) if there is no response from the driver after 20 seconds.

You must start over at the beginning of the process if Automatic Park Out cancels for any of the aforementioned reasons and you wish to use the system again.

### Surround View Monitoring

---

The Surround View Monitoring system uses the exterior cameras to display the immediate vehicle surroundings in real time. This system will assist you in situations, such as parking or exits with reduced visibility.

 Note: Surround View Monitoring is only available when the vehicle's speed is below 16 mph (27 kmph).

 **WARNING:** The Surround View Monitoring system should not be used as a replacement for looking into the interior and exterior mirrors or looking over your shoulder when operating and parking the vehicle. Always inspect your surroundings with your own eyes.

## Using Surround View Monitoring

Press  on the Pilot Panel to activate the system, then select **SURROUND VIEW**.

Surround View Monitoring will activate automatically on the Pilot Panel when the gear is in **R** (Reverse).

Press  at any time to close the screen.

 *Note:* Visual indicators for object distance will be displayed when Park Distance Warning is activated. See Park Distance Warning.

Use any of the following screen gestures to manipulate the view:

- Use one finger to press and drag, panning the screen to move the camera angle in any direction.
- Double tap the screen to zoom and center on the image. Double tap again to zoom out.
- Use two fingers to pinch in on the screen to zoom out the camera angle. Reverse the gesture to zoom in.
- Use all five fingers to pinch in on the screen and the system will return to the default top-down view.

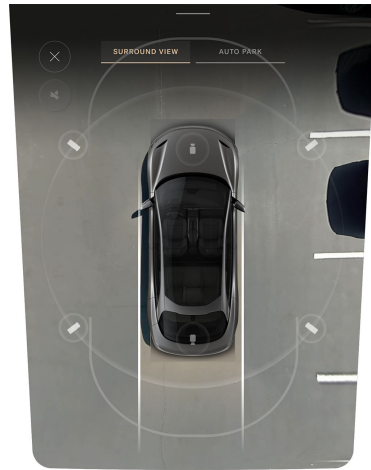

Press a  camera button in the default top-down view to switch to a 3D view from that camera angle.

Press a  camera button on the front or rear of the displayed vehicle to switch to the camera view from the front or rear bumper.

Press the  button in 3D view to switch to the top-down view.

### Surround View Monitoring Limitations

The Surrounding View Monitoring system may not function correctly in the following situations in addition to the limitations of Advanced Driver Assistance components (see DreamDrive Limitations):

- The trunk, hood, or a door are not closed.
- The side mirrors are folded in.
- The trunk or hood is open.

### Rear View Monitoring

Rear View Monitoring is an assist feature that will automatically display the rear

camera view on the Right Cockpit Panel when the vehicle shifts into **R** (Reverse). See Selecting a Drive Mode.

Press **P<sub>1</sub>** on the Pilot Panel to manually activate Rear View Monitoring.



Perform any of the following to manipulate the camera view:

- Swipe down on the screen to switch to the front camera view or up for the rear camera view.
- Pinch outward with two fingers on the screen to zoom in the camera angle. Reverse the gesture to zoom out.

 **Note:** The current magnification level will be displayed to the right of the camera view.

- Press the **+/-** buttons to zoom the view in/out.
- Press **X** to close the screen.

 **WARNING:** The Rear View Monitoring system should not be used as a replacement for looking into the interior and exterior mirrors or looking over your shoulder when operating and parking the vehicle. Always inspect your surroundings with your own eyes.

#### Park Distance Warning

Park Distance Warning uses the exterior sensors to provide you with visual and audible alerts when the vehicle is slowly moving towards a potential hazard.

 **Note:** This feature is only available at speeds below 10 mph (15 kmph).

 **Note:** The **Park Distance Warning** display will vary depending on the DreamDrive package.

The system will provide visual and audible alerts on these camera views when it is enabled:

#### Right Cockpit Panel:

- Rear View Monitoring

#### Pilot Panel:

- Surround View Monitoring

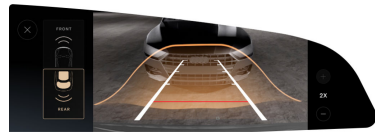

The shade of the visual indicator represents how close your vehicle is to an object. Objects that are further away will be indicated by a neutral shade.

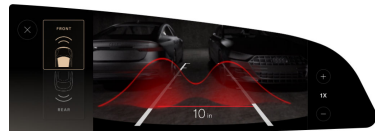



The visual indicator will gradually intensify to a darker shade of red as your vehicle approaches an object. **If this happens, apply the brakes to slow the vehicle and take any other appropriate corrective action.**

 **WARNING:** Park Distance Warning is an assist feature only, and will not act to prevent a collision. It is the driver's responsibility to assess the surroundings and take action when necessary.

---

## Park Distance Warning Settings

Touch  >  **DreamDrive** on the Pilot Panel then enable or disable **Park Distance Warning** to configure Park Distance Warning settings. The settings will save to the current user profile.



07

# Infotainment

# User Profiles

## About User Profiles

You can create multiple user profiles for your vehicle, enabling everyone to personalize their vehicle settings, including:

- Preferences for Entry into and Exiting from the Vehicle, see Loading and Switching Profile Preferences on page 141
- Seat Positioning, see Adjusting the Front Seats on page 35
- Positioning of Exterior Mirrors, see Adjusting the Exterior Side Mirror Position on page 83
- Certain Drive Settings, see Drive Modes on page 80
- Preferences for Units of Measurement; Press  >  **Displays > Units**
- Paired Bluetooth® Phones, including Synced Contacts, Calls, and Messages, see Pairing a Bluetooth Device on page 160
- Music and Audio Preferences, such as Radio Stations and Third-Party Media Applications, see Playing Media from Devices on page 151
- Interior Lighting and Display Themes, see Interior Lights on page 87
- Personalized Home and Work Navigation Destinations, see Navigation Overview on page 154

## User Profile Types

There are three types of user profiles, each with its own level of access:

- **Owner:** This is the main profile with access to all features, including



Lucid ID syncing and user profile removal. There is only one owner profile. See Creating a User Profile on page 139.

- **Secondary Driver:** This is for additional regular users of the vehicle who would like to create a user profile that can store their individual preferences and settings. The vehicle can save up to three secondary user profiles. See Creating a User Profile on page 139.
- **Guest:** This is for any user who requires temporary access to the vehicle or a regular user who does not wish to create a profile. The guest profile does not have access to any profile detection features and will not save adjustments to the seat, steering wheel, or external mirrors. There is only one guest profile.



## Creating a User Profile

### Setting up the Owner Profile

An Owner Profile setup prompt will appear on the Right Cockpit Panel in a new vehicle at the end of a driving session. Press **SET UP** to begin the setup process.

Press  >  **Access and Profiles**, followed by **SET UP THIS PROFILE** to manually access the setup on the Pilot Panel.

 **Note:** The vehicle gear must be set to **P** (Park) and remain there throughout the setup process.

 Note: Do not skip the first step. However, you can pause any subsequent steps by pressing **EXIT SETUP** and return to them later via the  **Access and Profiles** menu. You can also press **<** to return to the previous step.

1. Sign in with your Lucid ID to allow your data to be synced to other Lucid vehicles and the Lucid Mobile App. This will allow you to remotely access your vehicle and its data.

 Note: Your Lucid ID is set up at the time you purchase your vehicle. If you cannot locate your login information, contact Lucid Customer Care for assistance. See Customer Care on page 254.

2. Enter a profile name and select an avatar.
3. Enter a 5-digit Personal Identification Number (PIN) of your choosing, and enter it again to confirm. Confirm your identity with your pin if you chose not to enable Face Login.
4. Press and follow the on-screen directions to link a key fob or phone to your profile. Your vehicle will automatically load your profile if your linked device is detected.

 Note: The device must be in your hand during setup because some user interaction is required. Have the Lucid Mobile App open and signed into with your Lucid ID if you are linking a smartphone.

5. Use the touchscreen to set up your home and work addresses to access shortcuts to these destinations, such as when using

maps. See Maps and Navigation on page 154.

6. Set up facial recognition to quickly load your profile when you enter the vehicle.



### Setting Up Additional Profiles

To add another user profile:

- Sign in using the owner profile.
- Make sure the vehicle is parked and remains parked throughout the setup process.

Press **+** **Profile Settings** on the Right Cockpit Panel to launch the Access and Profiles settings on the Pilot Panel.

 Note: The option to create or add a user profile will not be available if the maximum number of profiles has already been added. Refer to Removing Secondary User Profiles on page 141 to delete a profile to add another.

Press  **>**  **Access and Profiles**, then **CREATE NEW PROFILE** on the Pilot Panel, and follow the subsequent steps after a prompt for the primary driver's PIN appears:

1. Enter a profile name and select an avatar.
2. Press to link a key fob or phone to the profile. Your vehicle will automatically load the profile if the linked device is detected. Follow the on-screen directions to link a device.



Follow the on-screen directions to link a device.



 **Note:** The device must be in your hand during setup because some user interaction is required. You must have the Lucid Mobile App open and signed into with your Lucid ID if you are linking a smart phone.

Profile Settings

There are multiple ways to access your user profile settings:

- Press your avatar image on the Right Cockpit Panel, then **PROFILE SETTINGS** to launch.
- Press  >  **Access and Profiles** on the Pilot Panel and toggle **Automatically Load Preferences** on or off (see Loading User Profile Preferences), or select an option from the listed menu options.

**Changing Profile Name and Avatar**

You can change the avatar for the owner profile and/or the name and avatar for the secondary profiles in the Lucid Mobile App.

**My Profile**

You can view and edit your home and work addresses or reset your personal identification number (PIN) under **My Profile**.

 **Note:** Secondary profiles must have access granted by the owner to reset a pin. When prompted, press **REQUEST ACCESS**. The Lucid Mobile App tied to the Owner’s Lucid ID will need to be opened within a certain time frame in order to grant access.

You will be prompted to **CONFIRM** loading your preferences on the Right Cockpit Panel when you enter the vehicle and confirm your user profile. This includes automatically adjusting to the saved steering wheel, seat, and mirror positions.

You can set your user profile to automatically load your preferences upon entry. See Profile Settings.

**Switching Between User Profiles**

Press the current avatar image on the Right Cockpit Panel. Then, select any user profile from the list. Switching between user profiles is only available when the vehicle is in **P** (Park).

Removing Secondary User Profiles

The owner can remove existing secondary user profiles from the vehicle, if desired. Removing a profile will delete all data and preferences for that user.

 **Note:** Only the owner can manage user profiles.

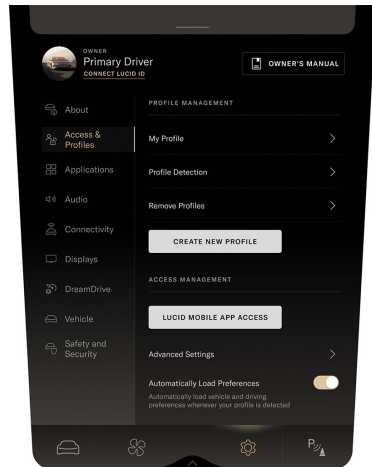

1. Press  > **Access and Profiles** > **Remove Profiles** on the Pilot Panel.
2. Press **EDIT** to bring up the editing screen.
3. Press **REMOVE** next to the profile to be removed. You will be prompted to confirm your selection.

#### Factory Reset

Factory Reset is a feature that wipes all user profile data from the vehicle, including the removal of any secondary user profiles that were created.

#### Performing a Factory Reset

The following conditions must be met before attempting a factory reset:

- Connected Lucid ID
- Vehicle Charged to at Least 20%
- Vehicle is in Park

Navigate to the **Access and Profiles** page on the Pilot Panel and select **Advanced Settings** to perform a factory reset.

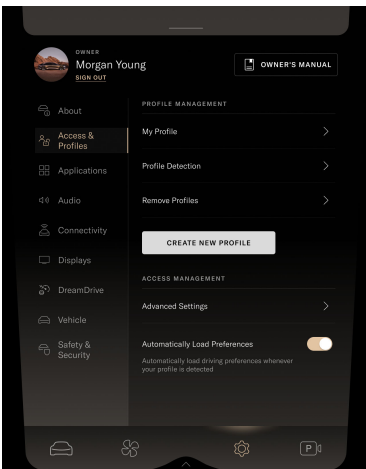

The **Factory Reset** feature is within Advanced Settings. You must confirm your decision before the reset proceeds. Furthermore, you also have the option of clearing all cloud data, as well as vehicle data by selecting the toggle switch.

 **CAUTION:** This step cannot be undone. All data will be lost forever.

You will see a series of **Factory Reset in Progress** screens after confirming factory reset. Factory reset will be complete and all data will be deleted when these screens disappear.

#### Changing Display Settings



Select  > Displays on the Pilot Panel, then tap either Units, Time Zone, or System Language to change the Unit of Measure, Language, and Time Zone.

#### Keyboard Language and Input Preferences

The onscreen keyboard lets you enter text input on the Pilot Panel, such as search bars, usernames, or passwords. Your preferences are saved to the profile.

#### Change Input Method

Use the onscreen keyboard to input text in three ways:

1. Alphanumeric keyboard 
2. Swipe to type on the Alphanumeric Keyboard
3. Handwriting Recognition 

#### Swipe to type

To type a word, select the first letter and then swipe across the keyboard. After you complete the word, lift your finger from the keyboard. The keyboard will display the closest match based on your input. You can change this by selecting the alternative word suggested at the top of the keyboard.

Pressing and holding the keyboard displays the alternative keyboard.

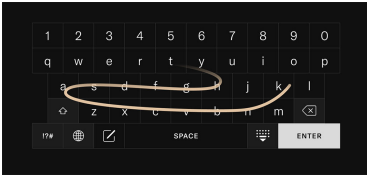

### Handwriting Recognition

1. Switch to handwriting mode and start writing the word either individual letters or the whole word.
2. After the word is complete, select the space bar to progress to the next word or choose an alternative word from the suggestions to select an alternative word and continue writing.

### Changing Input Language

The input language defaults to the vehicle's selected language. Change the input language when the keyboard or handwriting is open by pressing and holding the languages  button.

Alternatively, tap the icon to switch between the available languages without showing the languages' list. Pressing and holding the icon will show the list.

 **Note:** You cannot change the language once you have entered characters into an input field.

Changes to the input language are saved to your profile.

---

# Media and Audio

## Media Overview

---

Tap the Media icon  on the Right Cockpit Panel to launch the media overview.

Applications displayed in the Smart Drawer window on the Right Cockpit Panel allow you to browse the contents. The Pilot Panel view of the smart drawer shows additional controls for lists and libraries.

Tap on a media item to select and play media from that source.

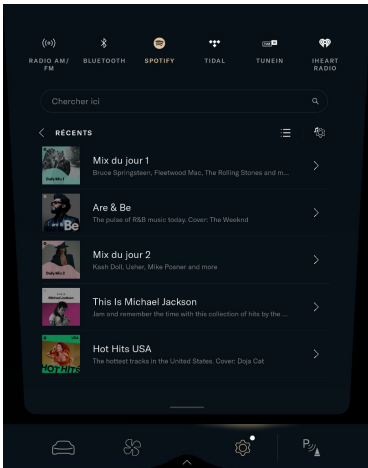
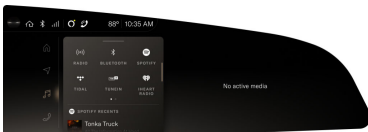

## Steering Wheel Media Controls



Use the following steering wheel controls when active media is playing or a call is in progress:

1. **Right Toggle/Center Button:** Press the button to play/pause the media playback, mute/unmute the radio, or to answer a call. Press once to answer an incoming call or press and hold to reject an incoming call.
2. **Rocker-Up:** Toggle and hold the button to increase volume.
3. **Rocker-Down:** Toggle and hold the button to decrease volume.
4. **Previous:** Press the button to skip to the previous available media. When using the radio, press to scan to the previous available frequency. See Radio on page 146.
5. **Next:** Press the button to skip to the next available media. When using the radio, press to scan to the next available frequency. See Radio on page 146.
6. **Voice Assistant:**  Use this feature to invoke the configured voice assistant.

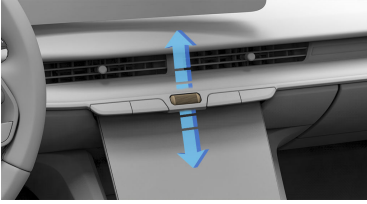



The toggle on the dashboard can adjust the volume when media is playing by scrolling up to increase or down to decrease the volume.

Use the Volume Roller or Steering Knob to adjust the volume of the active audio source. Control the volume for Phone, Media, Voice Assistant, and Navigation with the Volume Slider on the Pilot Panel. You can set the Media, Navigation, and Voice Assistant volume to different levels while the media plays. Once set, these settings will remain in effect until manually changed.

To mute/unmute the maps audio move the Navigation slider.

#### Searching Media Content

Use the  search bar to search for a particular song, album, artist, station, or podcast when media applications are opened on the Pilot Panel. Note that search may not be available for a particular media source.

 **Note:** Search functions are not available when the vehicle is not in **P** (Park).

#### Radio

##### About HD Radio™

Your vehicle is equipped with a special radio receiver that can receive digital broadcasts of local AM/FM stations and analog broadcasts. Many stations

broadcast a digital signal that may contain additional features not found in an analog signal. For more information, visit [www.HDRadio.com](http://www.HDRadio.com).

HD Radio Technology manufactured under license from iBiquity Digital Corporation. U.S. and Foreign Patents. For patents, see <http://dts.com/patents>. HD Radio and the HD, HD Radio, and "ARC" logos are registered trademarks or trademarks of iBiquity Digital Corporation in the United States and/or other countries.



Lucid and iBiquity Digital Corp are not responsible for the content sent using HD Radio™ technology. Content may be changed, added or deleted at any time at the station owner's discretion.

##### Using the AM/FM Radio application

Launch the AM/FM Radio application from the Right Cockpit Panel. Tap the Media icon  > **AM/FM Radio** via the launcher menu, then select AM/FM from the Smart Drawer.

You can select the desired category of radio stations from the main menu.

On the Right Cockpit Panel, press  > **AM/FM Radio**. The selected media will display with player controls.

- Press the  Favorites icon to add the current station to your Favorites list. The icon will turn solid when a station is added.
- The  icon will highlight when you are listening to an HD Radio station. Tap a channel number to switch stations.

HD Radio stations have a multicast indicator, (1 2 3....) and will appear if the current station has multiple digital broadcasts. Repeatedly press Seek Up or Down button to access the other digital broadcasts or tap a channel number to switch stations. The numbers that are highlighted signify available digital channels where new/different content

is available. HD1 will signify the main programming service and is available in analog and digital broadcasts. Any additional multicast stations (HD2–HD8) are only broadcast digitally.

**HD Radio Reception Factors**

Reception Area: If you are listening to a multicast, (HD2, HD3, etc.), station and are on the fringe of the reception area, the station may mute due to weak signal strength. If you are listening to HD1, the system will simply switch to the analog broadcast, until the digital broadcast is available again.

However, if you are listening to any of the possible multicast, (HD2–HD8), channels, the station will mute and stay muted unless it is able to connect to the digital signal again. The “swirl” icon will appear for a few seconds while in this state. If it is unable to reconnect to the digital signal, then the screen will be cleared and the text, "Station Unavailable," will appear in artist and title field area.

Station Blending: When a HD1 station is received, the system will play the analog audio broadcast from the station for a few seconds. If the receiver verifies that the station is an HD Radio station, it will transition to play the digital audio broadcast. You may hear a slight sound change when the station transitions from analog to the digital broadcast. The shift from analog to digital or digital back to analog sound is known as "blending," depending on the station quality.

Station Issues: A contact form has been developed to report any station issues found while listening to a station broadcasting with HD Radio technology to provide the best possible experience. Every station is independently owned and operated. These stations are responsible for ensuring all audio streams and data fields are accurate. The form can be found at: <https://hdradio.com/stations/feedback/>

**Troubleshooting HD Radio**

The table below describes how to troubleshoot certain issues:

Experience	Cause	Action
A mismatch of time alignment; a user may hear a short period of programming replayed or an echo, stutter, or skip.	The radio station's analog and digital volume is not properly aligned or the station is in ballgame mode.	Contact the radio station because it is a radio broadcast issue.
The sound fades, blending in and out.	The radio is shifting between analog and digital audio.	It is a reception issue. It may clear up if you continue to drive the vehicle. Turning the indicator of the "HD Radio" button off can force the radio in an analog radio.
The audio is mute when an HD2/HD3 multicast channel is playing.	The radio does not have access to digital signals at the moment.	This is normal behavior; wait until the digital signal returns. Seek a new station if you are out of the coverage area.

Experience	Cause	Action
There is an audio mute delay when you are selecting an HD2/HD3 multi-cast channel preset.	The digital multicast content is not available until the HD Radio broadcast can be decoded and makes the audio available. This takes up to seven seconds.	This is normal behavior; wait for the audio to become available.
The text information does not match the present song audio.	This is a data service issue by the radio broadcaster.	Notify the broadcaster. Complete the form: <a href="https://hdradio.com/stations/feedback">https://hdradio.com/stations/feedback</a> .
No text information is shown for the preset selected frequency.	This is a data service issue by the radio broadcaster.	Notify the broadcaster. Complete the form: <a href="https://hdradio.com/stations/feedback">https://hdradio.com/stations/feedback</a> .

SiriusXM®

## SiriusXM®

Your **Lucid Air** is equipped with SiriusXM. SiriusXM is a premium audio content service with a wide variety of ad-free music, news, sports, podcasts, and entertainment channels.

Upon first use, you will be guided through the setup process for accessing SiriusXM to start your listening experience.

### Subscription

Your vehicle comes with a SiriusXM trial subscription. Trial duration and service availability may vary by model, year, or trim. Service will automatically stop at the end of your trial subscription

period unless you decide to continue the service. Trial is non-transferable. If you do not wish to enjoy your trial, you can cancel by contacting SiriusXM. An active data connection must be enabled to access the service. All SiriusXM services require a subscription, each sold separately by SiriusXM after the trial period. All features, content and fees may change. **Use of the SiriusXM service is subject to the SiriusXM Customer Agreement and Privacy Policies available at [www.siriusxm.com](http://www.siriusxm.com) (U.S.) and [www.siriusxm.ca](http://www.siriusxm.ca) (Canada).**

Contact Information:

- US: 1-855-596-9555 or **Contact Us** at <http://www.siriusxm.com>
- Canada: 1-844-823-0844 or **Contact Us** at <http://www.siriusxm.ca>

### In-vehicle Data

You do not need to purchase an in-vehicle data plan to use the SiriusXM service separately. The SiriusXM service utilizes the cellular/Wi-Fi connectivity in your **Lucid** vehicle. Please ensure that a good cellular/Wi-Fi signal is available.

### Explicit Language Notice

Channels with frequent explicit language are indicated with an "XL" preceding the channel name.

### Media

To locate SiriusXM in your vehicle's Infotainment system, tap .

### Accessing SiriusXM

1. Tap **SIRIUSXM**  on the Pilot Panel to start the app.
2. Tap **LISTEN NOW**.
3. Accept the SiriusXM Terms and Conditions.
4. Enjoy your SiriusXM trial.



## Browsing Content

You can browse SiriusXM channels in several ways:

1. Tap **Search** 🔍 on the Pilot Panel to enable the keyboard search to browse various content options. Browsing results will return the most relevant content based on your search.
2. Tap **Categories** in the Smart Drawer to browse Music, Sports, News, and Talk Super Categories and explore the extensive SiriusXM content. This is considered an easy and convenient way to navigate through SiriusXM's library of Channels, Xtra Channels, Sports, and News content.

### Symbol Description

<CH	Skip to the previous channel
CH>	Skip to the next channel
◀	Skip backward
▶	Skip forward
	Pause
▶	Play
👍	Like a song & personalize the Pandora Station
👎	Dislike a song, skip to the next track and personalize the Pandora Station

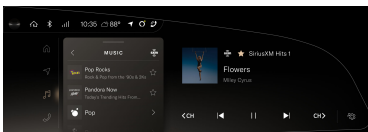

## SiriusXM Favorites

You can add Xtra channels, podcast shows, sports teams, and Pandora stations as **Favorites**. You can have unlimited favorites, but only your top 24 favorites are displayed.

1. Open the SiriusXM app.
2. Tap **Favorites** ☆ to save your favorite station or channel.

## Pandora Stations

Personalized Pandora Stations are customized music stations based on artists of choice in SiriusXM. To create a Personalized Pandora Station:

1. Tap **Search** 🔍 on the Pilot Panel to enable keyboard search.
2. Enter your favorite artist's name.
3. Tap on an artist in search results to play and create a Pandora station.

## SiriusXM - Live Sports

Easy access to live NFL, MLB®, NBA, NHL®, PGA TOUR, INDYCAR®, NASCAR®, and College Sports are available on SiriusXM.

1. Tap **Categories** in the Smart Drawer.
2. Select **Sports**.
3. Tap **Live Sports** to view all the games happening live.

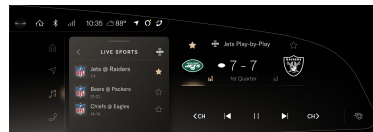

## For You Recommendations

Personalized recommendations include channels, episodes, and Pandora Stations based on your listening choices and SiriusXM Favorites. To view

recommendations, tap **For You** within the Smart Drawer.

## SiriusXM Settings

In Settings, you can manage and adjust your:

- Subscription Info
- Listener Settings
- System Setting
- Help and Support

From the Pilot Panel, tap **Settings**  to display the SiriusXM settings.

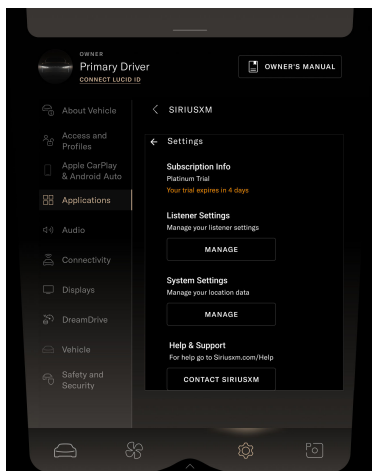

## NOTICE

It is prohibited to copy, decompile, disassemble, reverse engineer, hack, manipulate, or otherwise make available any technology or software incorporated in receivers compatible with the SiriusXM or that support any SiriusXM website or app. Software included in this product is protected by intellectual property rights, copyrights and trade secrets of SiriusXM Inc., SiriusXM Canada Inc. and their licensees.

## SiriusXM Customer Service Guarantee

SiriusXM guarantees to provide comprehensive customer service to you during the term of your trial subscription, including troubleshooting, assisting with online access, providing useful info regarding content and features, and account management. SiriusXM Listener Care is here for you in the United States at **1-877-447-0011** or via chat at **siriusxm.com/contactus** and in Canada at **1-888-539-7474**. To continue your service after your trial subscription ends, contact SiriusXM or go to **siriusxm.com/subscribenow** (USA) or **siriusxm.ca/signup** (CAN).

## Privacy Notice and How to Communicate with SiriusXM

In connection with your trial subscription included with your vehicle purchase or lease, Sirius XM **may collect your personal information from your dealer, automaker or other third party, or through the SiriusXM-enabled radio installed in your vehicle, to establish, activate and manage your subscription account, communicate important subscription information, improve the services SiriusXM delivers, market our services via mail, phone, email, or online, and for other business purposes.** For more info about the information SiriusXM collects, how they use it, and your rights relating to such use, visit **siriusxm.com/privacy** (USA) or **siriusxm.ca/privacy** (CAN). For more about U.S. state specific disclosures and rights where applicable, read **Your Privacy Choices** at **siriusxm.com/privacychoices**. If you have a preference on how SiriusXM contacts you, call them or set up and manage your preferences online at **siriusxm.com/myaccount** (USA) or **siriusxm.ca/myaccount** (CAN).

©2023 Sirius XM Radio Inc. and SiriusXM Canada Inc. SiriusXM, Pandora and all related marks and logs are trademarks of Sirius XM Radio Inc, and/or SiriusXM Canada Inc. All marks, channel names, logos are the property of their respective owners. All rights reserved.

---

 Apple CarPlay®
 

---

The Infotainment system is compatible with Apple CarPlay®. To use this application, you must have a compatible iPhone paired to the vehicle (see Pairing a Bluetooth Device on page 160) or plugged into a USB port.

For more information, see the Apple website: [www.apple.com/ios/carplay](http://www.apple.com/ios/carplay).

### Connecting to CarPlay

You can launch CarPlay in two ways:

- By connecting your iPhone via USB on the center console.
- By pairing your iPhone via Bluetooth®.

Once connected, you can use your smartphone's Siri voice assistant by long pressing the voice assist  button on the steering wheel.

 **Note:** Your vehicle will share information with your device, including vehicle, location, and voice data.

### Entry point on the homeapp

The CarPlay entry point present on your home app provides an intuitive way to launch CarPlay UI for your CarPlay connected device.

### Managing your CarPlay connection



In the device manager you will see which device is currently connected to CarPlay.

The CarPlay icon  is displayed in active status for the CarPlay connected device.

You can switch CarPlay connections by tapping on the non-active CarPlay icon of the device you wish to activate. That device is now the active CarPlay device.

### Disconnecting CarPlay

To disconnect CarPlay:



1. On the Pilot Panel, select  >  **Connectivity > Devices**.
2. Tap the Apple CarPlay icon next to the name of the iPhone that is connected for Apple CarPlay.
3. This will unselect the icon, and CarPlay will disconnect.

---

 Logging into Media Applications
 

---

You can directly control and personalize your apps through many third-party media applications that can be logged into via the Pilot Panel.

Select  >  **Applications** on the Pilot Panel for a list of available third-party media.

 **Note:** Many third-party media applications require a data connection and login information, and some services are subscription-based. Refer to the provider for more information.

---

 Playing Media from Devices
 

---

The Infotainment system can play media from USB or Bluetooth® connected devices.

### Bluetooth

Connect your Bluetooth device to the vehicle Infotainment system (see Pairing a Bluetooth Device on page 160). Select a Bluetooth® source via the list of media applications on the Right Cockpit Panel or Pilot Panel.

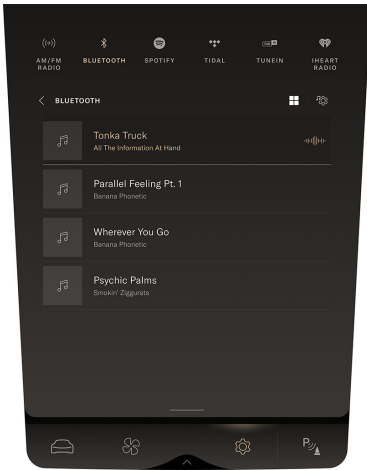



## USB Device

You can play media from a USB flash drive, (also called a USB stick, thumbdrive, or pendrive), by inserting the drive into one of the two front USB C ports (see USB Connections on page 104). Select a USB source from the list of media applications on the Right Cockpit Panel or Pilot Panel.

 **Note:** You can choose either front USB port, but only one port is supported at a time.

## Audio Settings

Select  >  **Audio** on the Pilot Panel to access the audio settings:

- **Equalizer:** Adjusts the bass, mid, and treble
- **Balance:** Adjusts the sound level between the speakers
- **Volume:** Adjusts the master volume and the volume levels for the navigation system and phone

# Using Alexa

Alexa Built-In

## Overview

The Lucid Air comes equipped with Amazon Alexa Built-In, allowing users to give voice commands for navigating to destinations, making phone calls, sending and receiving text messages, playing music, adjusting temperature, and controlling smart home devices.

-  *Note:* Alexa might not be able to speak the language used in your region. However, you can choose to use Alexa in the languages that it currently does support.

## Authentication

To sign into Alexa:

1. Go to **Settings > Applications > Alexa** on the Pilot Panel.
2. Go to **amazon.com/code** on your mobile device and enter the 5-character code or scan the QR code displayed on the Pilot Panel.
3. If a mobile device has been connected, you will be prompted to enable Alexa to access contacts and read messages.
4. If a mobile device has not been previously connected, the Alexa Settings screen will appear.

## Invoking Alexa

You can invoke Alexa in one of two ways:

- Press and hold the Voice Button  on the Steering Wheel
- Say **Alexa**

## Things to Try With Alexa

Go to **Settings > Applications > Alexa > Things** to try once you are signed in to see a list of sample Alexa commands.

## Calling and Messaging Setup

1. Ensure your phone is paired and connected under **Settings > Connectivity > Bluetooth** and tap on the ellipsis to access phone options.
2. Turn on the **Sync Messages** and **Sync Contacts** toggles; this gives the the **Dialer** app access to the messages and contacts on your phone.
3. Turn on the **Allow Alexa to Access Contacts** and **Allow Alexa to Read Messages** toggles; this gives Alexa access to the messages and contacts from the Dialer app.
4. Alternatively, go to **Settings > Applications > Alexa > Settings > Communication** and ensure that the toggles are turned on.

---

# Maps and Navigation

## Navigation Overview

---

Press the  icon on the Right Cockpit Panel to access navigation. The screen will display your current location and street name (where applicable).

If you pan away from the current location, the street name will be replaced by a Recenter button. Touching Recenter is a quick way to return to the default view showing the current position.

 **Note:** The user profile that first uses the navigation system will receive a prompt and that user must read and agree to the Terms and Conditions before proceeding.

The smart drawer can expand the Navigation screen into the Pilot Panel for additional menus not available in the Right Cockpit Panel.

## Search

---

Open the smart drawer on the Right Cockpit Panel to select a destination. Use voice commands to navigate hands-free. Tap the search icon to choose from one of the search category shortcuts or recent destinations and search terms.

Save Home and Work locations using  icon after searching for a location.

Move the smart drawer into the Glass Cockpit to access additional options:

- Use the **Search** bar to type an address or a business name via the on-screen keyboard.
- You can also select one of the six categories. Swipe left or right to view additional categories.
- Make your own shortcuts for **HOME** and **WORK**: Select from your

saved home and work locations. See Setting Home and Work Destinations on page 159.

- You will see **RECENTS** by default when opening Search. Before typing anything in the search bar, you can select from the list of recently-used destinations or search terms. Those places will be replaced with search matches if you start typing something.
- In the Search function, you may pan the map to another location and tap Search This Area to refresh the search results with matches for the new area.

When routing, you have two additional ways to search:

- Along the Route
- Near Destination

## Navigation Settings

---

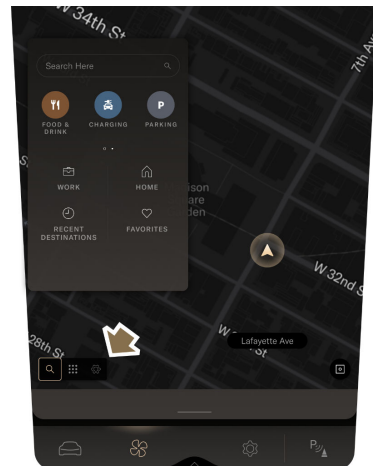

Press the  icon on the Navigation screen via the Pilot Panel to configure navigation options, including:

- **Satellite Imagery:** This toggles preferences for showing Satellite Imagery as the background map. When connectivity is poor, the Satellite images might initially look blurry while they fully load.
- **Traffic:** This toggles preferences for showing traffic on map, such as flow and incidents. This feature requires connectivity to work. When connectivity is poor, the Traffic information on the map may be slow to load. Traffic is visible at several zoom levels, while zoomed in at city level and street level views.
- **Offline Mode:** Navigation App settings now have an offline mode if users are concerned about privacy. You will not be connected to a server, but GPS is still available. Before switching to Offline mode, you must first download maps while you are still connected via WiFi or cellular connectivity. While in Offline Mode you can do Offline Search (limited to in-map businesses), Offline Routing (not considering Traffic or Charging) and can hear Offline turn-by-turn route guidance.

 **Note:** The number of Points of Interest for Search is more limited and the route will no longer be an EV Route (it won't auto-add charge stops, if needed), if connectivity is lost and you are only using downloaded maps.

- **Offline Maps:** Users can now download one or more states or provinces at a time. Offline maps are used when connectivity is lost, or in Offline mode. You can also pause and resume a download to

control what gets downloaded and when.

- **Personal Data:** The navigation system collects personal location data to improve your trip recommendations. You can permanently delete your personal data from this screen.

 **Note:** Only a primary user can accept or reject Terms and Conditions or delete downloaded maps. If the primary user declines Terms and Conditions, navigation will stop working for all users until the Terms and Conditions are accepted.

Anonymous longitude/latitude data is shared with our navigation service partner to enable Search and Routing, but personal data is locally saved. Both primary or secondary users can delete their own data. The navigation will still work in Guest mode after deleting, but home, work, and destination history will be erased.

 **Note:** Deleting personal location data cannot be undone. Lucid does not store a copy of this data.

#### Charging Category Search

---

Tap the **CHARGING** search category icon for the best way to search, sort and filter Charging Stations locations. These will include plug type and availability information by Stand (not by Plug) wherever possible. The plug type and availability information requires connectivity.

The default view shows nearby Lucid Charging Partner's DC fast chargers above 150 kilowatts, which provide the best charger user experience. You can adjust your Filter options to see more.

There is a toggle to see nearby **trusted** charging brands and locations and Lucid Charging Partners.

 **Note:** Only public chargers will be shown.

 **Note:** Your connection will attempt to supply power up to the published power output. The actual power delivery may be lower, depending on external factors.

You can also manually sort and filter chargers based on criteria, such as availability, distance, power, plug type, or charging vendor (such as Electrify America, Electrify Canada, or **Lucid Partner of Top Brands** in Europe).



 **Note:** DC FAST Chargers are not yet available in some countries. The EV Routing feature will, therefore, not be able to auto-add DC Charging Stops. Because of this, **Lucid** recommends manually searching for nearby chargers and adding them as stops on your route. However, the new route ETA will not be able to calculate an ETA for manually

added stops that include any potential charging time. Allow extra travel time if you manually add a charging stop.

## Routing

All Lucid routes are EV Routes by default, when connected. Lucid EV routes are integrated with your vehicle range and consumption profile. Lucid EV Routes also consider the current state of charge, road profile, temperature, heating, ventilation, air conditioning (HVAC), and traffic conditions, when predicting your unique vehicle consumption over time under those conditions.

The map will display an overview of the proposed route on both the Right Cockpit Panel and Pilot Panel once a location is specified. Up to three route options will be shown, each with its own written summary and visual display. The recommended top option is the fastest route, with the least over-all travel time (driving + charging time combined), and is shown on the map in blue. Other alternative suggestions are shown in gray. Traffic conditions on each route will also be included. Charge stops will be auto-added to and displayed on all three routes, if required.

You can preview and plan your route on the **MY ROUTE** screen before tapping **GO**.

For EV Routes which require charging stops, the Nav system has auto-added Charging Waypoints. The auto-added Waypoints will display the Brand name of the Charger (if available) in addition to the current charging location's name and address.



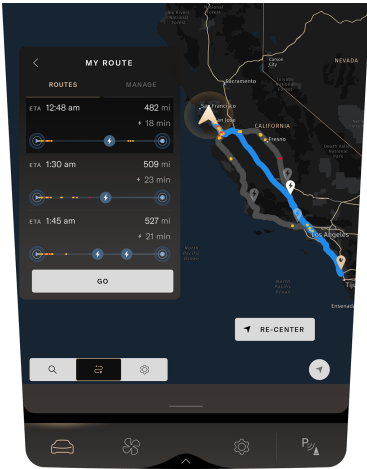

 **Note:** The system predicts the estimated remaining energy when you later arrive at a Waypoint or Destination. The predicted energy estimation is regularly updated in real-time as you drive toward your Waypoint or Destination.

After you start driving, alternate navigation routes will be continuously displayed on the map. They are easily identifiable by a different color and an info bubble displaying the time difference between them. To change routes, tap on the route or the info bubble. The alternate routes will automatically update after a decision point is passed based on new options ahead.

The alternate routes provide different options to choose from, allowing you to select the most suitable one for your needs. When connected, the alternate routes will be shown as the EV Routes with auto-added stops, if needed. However, even if you're not connected, alternate routes still work for non-EV routes.

Traveled Route portion is displayed on the Map behind the vehicle icon.

The turn-by-turn guidance instructions will show on the top navigation screen once the route has started. Lane guidance, exit numbers, and other guidance details will display when appropriate. If the navigation is replaced with media or phone while routing, navigation instructions will remain in view in the Center Cockpit Panel.

Extra details will be provided for each stop when the system automatically adds charging stops, such as the predicted percent of energy on arrival, suggested plug type to use, number of minutes to charge for, and minimum percent to charge up to.

This information will show persistently in both the **DETAILS** and **MANAGE** tabs until your route ends. You can directly tap each Waypoint on the route from the map view to access more details.

When you arrive at an Auto-Added Charging Waypoint, this information will remain on the screen until you dismiss it. You can now review the recommendation and make sure you're comfortable with it before proceeding.

 **Note:** The Navigation App calculates to predict energy usage along the route. For more information, see Predicting Energy Usage on page 158.

The smart drawer will show a full list of instructions when you start a trip. This list will automatically minimize after thirty seconds to use the full screen for viewing your maps and route. The route will display all of your stops and traffic conditions.

The smart drawer can be manually reopened by tapping the center icon in the lower left of the Pilot Panel. See the **DETAILS** tab for the list of remaining turn-by-turn instructions. See the **MANAGE** tab for a list of just the stops. You can add, reorder, or delete stops.

---

If you deviate from the route at any point, the system will immediately and automatically recalculate a new route and issue new instructions.

The route will continue to be present on the screen if, while routing, you have to stop and turn off the vehicle and come back and turn it on.

Press **END** or use voice commands, such as **cancel navigation**, to end navigation.

An **Insufficient Charge** notification will appear on navigation if the EV route requires charging, but a fast charger could not be automatically added along the route. In this case, we recommend that you manually search for charging. Slow chargers can usually be found and used along the route.

 **Note:** When routing starts, a mute button will appear on the top navigation screen, enabling you to turn off the audio guidance.

---

#### Predicting Energy Usage

When connected, the **Auto-Add Charging** feature is always **ON** and helps anticipate the vehicle's charging needs for a trip. This feature automatically adds DC charging stations to a calculated route, as needed.

 **Note:** You must manually search and add a charging stop to your route if no DC charging stations are available. For manually added chargers, the route ETA calculation will not be able to estimate the required charging time.

#### Using Range On Map

The Lucid Range On Map provides a visual representation of anticipated range based on your current battery state of charge, traffic conditions, elevation changes, and more. To display the Range On Map, select the feature using the map controls.

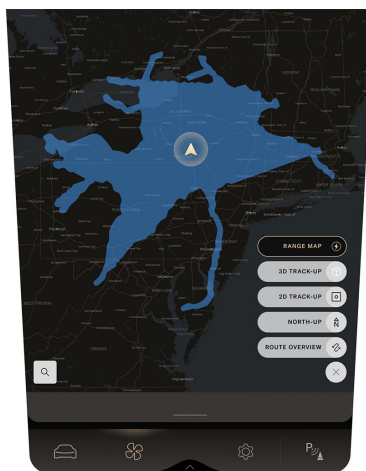

---

#### Adjusting the Map

The maps on either the Right Cockpit Panel or the Pilot Panel can be individually rotated, panned, or zoomed in and out via the touchscreen. The **RECENTER** button will appear any time the map is manipulated beyond your vehicle's current position. Tap it to return to your current position.

Pinch to zoom, or use one finger to double tap the touchscreen and zoom in on the map. Use two fingers to tap the touchscreen to zoom out. Swipe two fingers on the touchscreen to access a 3D view of the map.

The map centers around your current location by default and the current street name is displayed.

The Pilot Panel and Glass Cockpit can maintain their own independent map setting and zoom level whether routing or not. Touch the icon in the lower right of the map to select from one of five default map viewing modes:

- **Range Map:** Shows the approximate range that can be traveled using your current level of charge.

- **3D Track-Up:** 3D view that tracks your vehicle's current position, and rotates the map to show what is in front of the vehicle.
- **2D Track-Up:** 2D view that tracks your vehicle's current position, and rotates the map to show what is in front of the vehicle.
- **North-Up:** 2D view where North is always at the top of the map.
- **Route Overview:** Displays your current route end to end.

 **Note:** The **Route Overview** option will only appear when a route is selected.

The default map views will be ignored once you start manually interacting with the map. The system will maintain your personal user mode until you select one of the default views listed above.

The map contains features such as real time traffic, buildings, realistic 3D landmarks in most city centers, and points of interest. Points of interest can be selected from the map to see details and create a route to them. You can also tap a random place on the map to view their coordinates and make a route to that point.

It is also possible to turn on and off traffic and satellite maps in the Navigation app settings.

#### Setting Home and Work Destinations

Common destinations, such as your home or workplace, can be stored as shortcuts in the system, allowing you quick access within the Navigation menus.

If the Home and Work icons are already set in the Search drawer, they can be used as one-touch shortcuts to start a Route. Otherwise, type your address in the Search bar, select it to see the details tab, and tap the heart icon  to save as Home or Work location. Home and

work locations can also be set using voice commands and in vehicle Profile settings.

The applicable icon will appear next to the destination under its details.

The option under its details will change to **Remove** once a destination is set in this manner.

#### Map Updates and Offline Mode

Your in-car Navigation system will first try to get the newest maps around you over a wireless connection because it is connected-first. The system will fall back on using stored, offline maps, (on-board), if connectivity is temporarily unavailable. A small amount of nearby maps will automatically download for offline use, it is recommended to download your entire state for offline use manually.

**Lucid** strongly recommends you download your local state or province as a backup map in case connectivity is ever lost. You can download as many maps as you would like and can update them as often as you want, via deleting and re-downloading them. However, downloading maps requires connectivity, and is very fast when you have strong connectivity.

The local auto-downloaded maps are self-healing and are automatically updated over-the-air with no user intervention when a data connection is present as they become available.

When Offline, the Nav system can only display, search, and the route based on local or downloaded maps. Search results will be labeled as OFFLINE RESULTS, and routes will not be based on the traffic or EV considerations.

---

# Phone and Smart Devices

## Bluetooth® Wireless Technology

---

You can pair a Bluetooth-capable phone with your vehicle for hands-free use when in operating range. Bluetooth usually supports a wireless connection of approximately 30 feet (9 m), although the range can vary depending on atmospheric conditions and the device used.

You must pair your phone with the vehicle first to use it. See Pairing a Bluetooth® Device.

Two devices can be simultaneously connected. For example, if you own a personal phone and wish to stream music while taking calls from your work phone, you can connect a first device for phone features and a second device for media. The same device can alternatively be connected for both phone and media. However, only one device can be connected for each feature.



 **Note:** Other Bluetooth-capable devices can also be paired to your vehicle for use, such as an iPad or Android tablet.

## Pairing a Bluetooth Device

---

Pairing a phone to your vehicle enables you to place and receive hands-free calls and access your phone's contacts, messages, and recent call list. It also allows you to play media from various media apps from your device. Your phone will automatically connect to your vehicle whenever it is in range once it already has been paired.

To pair a device, have it with you in the vehicle and ensure it has Bluetooth® enabled and is discoverable. Then, follow these steps:

1. On the Pilot Panel, select  >  **Connectivity > Devices.**

2. When Bluetooth is enabled from the vehicle, tap Add Device to start scanning for devices. Tap the device to be paired. If the desired device is not seen, ensure the device is discoverable and tap RESCAN to scan it and try again.

 **Note:** Pairing must be initiated from the vehicle and cannot be done from your device.

3. **CONFIRM** the pairing code on your device when prompted if the pairing code on the screen matches the one on your device.
4. If prompted by your device, select whether to allow access to your contacts and messages.

The name of the device will be listed under **KNOWN DEVICES** when it is successfully paired and indicate that it is **CONNECTED**. A paired device will be connected for both phone and media by default. You can change device settings to disable your phone or media after pairing is complete.

Alternatively, you can initiate pairing or reconnect to Bluetooth from your mobile device.

To start pairing or reconnecting from your mobile device, go to your Bluetooth settings and tap on your vehicle's name. Your vehicle will only be discoverable for one minute. To make it discoverable again, turn off and on the Bluetooth toggle.

## Syncing Contacts and Messages

---

You can configure access to phone contacts and messages once a phone is paired, allowing you to make calls and display messages from contacts stored in your phone. Follow these steps:

1. Select **EDIT** next to Known Devices on the Pilot Panel Devices screen to reveal more options for each known device. Then, select the preferences button  for the device that you wish to edit.
2. Toggle the options to sync messages and contacts with the vehicle via this screen.
 

 *Note:* Larger contacts' lists can take more time to sync.
3. Go to your mobile device's Bluetooth settings and ensure that you have allowed text message notifications to sync your messages. See Editing Bluetooth Enabled Device Preferences on page 161 for more information.
4. Press **SAVE** to keep these settings and return to the previous screen.

Connecting and Disconnecting Bluetooth-Enabled Devices

Your paired phone will connect or disconnect automatically when it enters or exits the range of your vehicle. If you wish to connect to a different paired device:



1. Press **EDIT** on the Pilot Panel **DEVICES** screen.
2. Press the **DISCONNECT** button next to the device to be disconnected.
3. Press **DONE** when you have finished disconnecting any unwanted devices.
4. Tap the name of the device to be connected under **KNOWN DEVICES**.

You can alternately use the Right Cockpit Panel. Press the  icon in the status bar to display connected devices and connect or disconnect.

Editing Bluetooth Enabled Device Preferences

To edit device preferences:

- Select the phone or audio icon next to any device on the Pilot Panel **DEVICES** screen to connect or disconnect it for that functionality. These changes will automatically be saved as your preference. Message and contact syncing preferences can also be changed for any device. See Syncing Contacts and Messages on page 160 for more information.

If you no longer wish to use a device with the vehicle:

1. On the Pilot Panel **Bluetooth** screen, select **EDIT** next to Known Devices to reveal more options for each Known device.
2. Press the **FORGET** button next to any device you wish to remove.
3. Press **Done** when you have finished unpairing any unwanted devices.

Using the Phone App

 **WARNING: Distracted driving can lead to loss of vehicle control and a collision, which can result in serious injury or death. Lucid strongly recommends that the driver stay focused on the road at all times while driving. Safe operation of the vehicle is the driver's primary responsibility.**

 **WARNING: Always ensure you are following all applicable local laws regarding the use of phones while driving. This includes, but is not limited to, laws that prohibit texting and require hands-free phone operation at all times.**

---

Tap the  phone icon on the Right Cockpit Panel to open the phone smart drawer.

The phone smart drawer can be opened on the Pilot Panel when needed to show more detailed lists and information.

- **CONTACTS:** This option displays a synced contact list. See Syncing Contacts and Messages. Contacts can be searched and sorted on the Pilot Panel.
- **DIALPAD:** This option opens the dialpad for making manual calls.
- **FAVORITES:** This option displays a synced list of favorite contacts.
- **MESSAGES:** This option allows you to have text messages read aloud and send preset text messages. See Using Messages.

#### Making and Receiving Phone Calls

---

Use either method to make a phone call:

- Select a contact from the **CONTACTS**, **FAVORITES**, **MOST DIALED**, or **RECENT CALLS** lists.
- Use the **DIALPAD** screen to manually dial a number.

 *Note:* If it is safe and legal to do so, you may also make a call using the phone you have paired to your vehicle.

#### Receiving a Call

Incoming calls from a paired phone will display an alert on the right Pilot Panel. Any contact information for that caller will be displayed if your phone contacts have been synced to the vehicle. See Syncing Contacts and Messages on page 160.

 *Note:* For iPhone users:

- The call audio will always be routed through the car system if you take the call from the car system.

- The call audio will depend on iPhone **Call Audio Routing** setting if you take the call from your iPhone.

Press an option on the touchscreen or use the steering wheel controls to **DECLINE** or **ACCEPT** the call.

 *Note:* Your phone may prompt you to select the audio output for the call, depending on the type of phone and last output used.

#### Call Audio Routing for iPhone users

The **Call Audio Routing** setting can be configured in one of three ways:

- Automatic - The iPhone routes the audio to the phone, even though it is connected to the car via Bluetooth.
- Bluetooth Handset - The iPhone routes the audio to the car when the phone is connected to the car via Bluetooth.
- Speaker - The iPhone routes the audio to the phone speaker, even though the phone is connected to the car via Bluetooth.

#### In-Call Options

---

Active calls are displayed on the Right Cockpit Panel.

- The  active call icon will display in the status bar when a call is in progress.
- The contact information and call length will display on the main screen, along with call control buttons.

 *Note:* If your phone connects to the **Lucid** phone dialer app while a call is already in progress, the call time on the dialer app may not match the call time on your phone.

The call control buttons change if a call is placed on hold and a second call is made:

- Press **Swap** to switch between the active call and the call on hold.
- Press **Merge** to bring both callers into a shared call.

The call volume and mute option are controlled with the physical controls in your vehicle. See Physical Media Controls on page 145.

#### Using Messages

 **WARNING: Distracted driving can lead to loss of vehicle control and a collision, which can result in serious injury or death. Lucid strongly recommends that the driver stay focused on the road at all times while driving. Safe operation of the vehicle is the driver's primary responsibility.**

 **WARNING: Always ensure you are following all applicable local laws regarding the use of phones while driving. This includes, but is not limited to, laws that prohibit texting and require hands-free phone operation at all times.**

Tap the  phone icon on the Right Cockpit Panel to open the phone smart drawer and select **MESSAGES**.

Unread messages will be indicated by a dot, which will disappear once a message is played back. Press a message to have it read aloud, and press again to stop playback.

Press the  compose icon to send a new message. Select the recipient and the preset message, then press **SEND**.

### Incoming Messages

Incoming messages from a paired phone will display an alert on the right Pilot Panel. Any applicable contact

information will be displayed if your phone contacts have been synced to the vehicle. See Syncing Contacts and Messages on page 160.

Press an option on the touchscreen or use the steering wheel controls to **PLAY** the message, **CALL** the sender, or **REPLY** with a preset message.

---

# Connecting the Vehicle to Wi-Fi®

## Add a New Wi-Fi Network



---

### Add a Wi-Fi Network

Your vehicle can connect to a Wi-Fi network to send and receive data, which is often faster than cellular networks. Lucid recommends leaving Wi-Fi enabled and connected to a network whenever possible to receive software updates in a timely manner.

 **Note:** Connecting to a Wi-Fi network may result in large amounts of data being transferred to/from the car. Lucid is not responsible for any overages or charges related to Wi-Fi usage.

To connect to a network:

1. Select  >  **Connectivity > Networks** on the Pilot Panel.
2. The system will scan for available networks in range when the Wi-Fi is enabled. Select the network you wish to use under **OTHER NETWORKS**. Enter a password, if prompted, and press **JOIN**.
3. The name will appear under **CONNECTED NETWORK** if the connection succeeds.

Added networks not currently connected are listed under **SAVED NETWORKS**. Tap a network name to connect to it.

### Edit or Remove a Wi-Fi Network

1. Press the three dots next to a network to view its properties.
2. You can view network information from here or press **FORGET NETWORK** to remove it from your list.

## Wi-Fi Quick Access

Press the status bar on the Right Cockpit Panel to expand it, then the  Wi-Fi icon to open its menu.

From this menu, you can:

- Toggle Wi-Fi on/off
- View the currently connected network
- Press to switch to a saved network
- Press **Wi-Fi Settings** to open that screen on the Pilot Panel



# HomeLink

What is HomeLink?

HomeLink is a wireless control system that enables you to remotely operate up to 15 Radio Frequency (RF) devices, such as garage doors, gates, lights, and home security systems.

Additional system information can be found online at [www.homelink.com](http://www.homelink.com).

HomeLink Regulatory Advisory

## FCC/ISED Advisory

### FCC (USA) and ISED (Canada)

This device complies with FCC rules part 15 and Innovation, Science, and Economic Development Canada RSS-210. Operation is subject to the following two conditions: (1) This device may not cause harmful interference, and (2) This device must accept any interference that may be received including interference that may cause undesired operation. **WARNING:** The transmitter has been tested and complies with FCC and ISED rules. Changes or modifications not expressly approved by the party responsible for compliance could void the user's authority to operate the device.

1. This device may not cause harmful interference.
2. This device must accept any interference that may be received including interference that may cause undesired operation.

 **WARNING:** The transmitter has been tested and complies with FCC and ISED rules. Changes or modifications not expressly approved by the party responsible for compliance could void the user's

authority to operate the device.

This equipment complies with FCC and ISED radiation exposure limits set forth for an uncontrolled environment. End Users must follow the specific operating instructions for satisfying RF exposure compliance. This transmitter must be at least 20 cm from the user and must not be co-located or operating in conjunction with any other antenna or transmitter.

### FCC (États-Unis) et ISED (Canada)

Cet appareil est conforme aux règlements de la FCC, section 15, et au CNR-210 d'Innovation, Sciences et Développement économique Canada. Le fonctionnement est assujéti aux deux conditions suivantes : (1) cet appareil ne doit pas causer d'interférences nuisibles et (2) cet appareil doit accepter toute interférence reçue, y compris celle qui pourrait entraîner un dysfonctionnement. **MISE EN GARDE :** L'émetteur a subi des tests et est conforme aux règlements de la FCC et d'ISDE. Les changements ou modifications non approuvés explicitement par la partie responsable de la conformité pourraient rendre caduque l'autorisation de l'utilisateur de se servir du dispositif.

Cet appareil est conforme aux limites d'exposition aux radiations de la FCC et d'ISDE établies pour un environnement non contrôlé. Les utilisateurs finaux doivent respecter les instructions d'utilisation spécifiques pour satisfaire aux exigences de conformité aux expositions de RF. L'émetteur doit se trouver à 20 cm au minimum de l'utilisateur et ne doit pas être situé au même endroit que tout autre émetteur ou antenne ni fonctionner avec un autre émetteur ou antenne.

-  **WARNING:** Do not use HomeLink with any garage door opener that cannot detect an object and signal the door to stop and reverse as required by U.S. Federal Safety Standards (including any garage door opener manufactured before April 1st, 1982). A garage door opener which does not have the safety stop and reverse feature does not meet current federal safety standards. Using a garage door opener without these features increases the risk of serious injury or death.

Have the remote for the garage door or gate you are programming ready to set up a new HomeLink program and follow these steps:

1. Select  >  **Connectivity > HomeLink** on the Pilot Panel then press **+ ADD NEW HOMELINK**.

 *Note:* Press **CANCEL** during any step of programming to return to the main HomeLink® screen. No information will be stored.

2. Use the on-screen keyboard to enter a name for your HomeLink®, then press **CONTINUE**.
3. Prepare your surroundings as instructed on the screen, and press **CONTINUE** when you are ready to proceed.

 *Note:* Select **Program with D-Mode** only if your device requires D-Mode programming per the HomeLink website or operator's manual.

4. To record the remote signal, press and hold the remote 2 in (5 cm) below the letter L on the front of

your vehicle, until the horn sounds and the headlights flash.

5. Press **CONTINUE** once the Pilot Panel shows that recording is complete.

 *Note:* The on-screen process will automatically skip this step and proceed to the following test if it detects that your device uses a fixed code.

Press the **LEARN** button on the back of your receiver, (removing the cover if needed), to train the receiver. Press **CONTINUE** on the Pilot Panel.

 *Note:* A second person can assist with this step since pressing the **LEARN** button is time-sensitive.

 *Note:* You can press **CONTINUE** if your receiver is QuickTrain compatible.

 *Note:* You will have 30 seconds to test HomeLink after pressing the 'LEARN' or sync button. An error message will display with the option to try again if a signal is not detected within the timeout period.

6. Press the **TEST HOMELINK** button to test it. You will need to press this three times in total. Wait until you see a check mark before pressing the button a second and third time.
7. The **TEST HOMELINK** button will temporarily be unavailable during each brief test, while the current test number animates to indicate that it is in progress.



 *Note:* The device you are programming may respond during any of these three tests. Continue with all three tests.

- A check will replace the number after a test completes and the **TEST HOMELINK** button becomes available. Continue through all three tests.
- The screen will prompt you to confirm whether the device responded after all three tests have completed. Press **YES** or **NO**.

 *Note:* Pressing **NO** will give you the option to restart the test and contact information for HomeLink Help.

- You will be brought back to the **Connectivity** screen if you press **YES**. Your new HomeLink device will be listed under **CONNECTED DEVICES**.

### Reprogramming a Device

- Select  >  **Connectivity** > **HomeLink** on the Pilot Panel, then click the device to be reprogrammed.
- Press **PROGRAM** on the device details screen.
- Follow the steps for programming a device. See Programming Homelink.

#### Using HomeLink®

The devices can be accessed using the HomeLink menu on the Right Cockpit Panel once they have been programmed to your vehicle.

The HomeLink menu will automatically open when the vehicle is detected within 131 ft (40 m) of a programmed garage door or gate. To manually access it:

- Press the status bar to expand.
- Press  to open HomeLink.

From this menu, you can:

- Press **HOMELINK SETTINGS** to add a new device, edit, or remove

existing devices. See Renaming or Deleting a Device.



- Press a device name to activate it.

The  icon next to a device indicates that a signal has been sent to the door or gate. The menu automatically collapses three seconds after a signal is sent.



#### Renaming or Deleting a Program

 *Note:* It is recommended to delete all programmed devices upon the sale or lease termination of your vehicle for your security.



### Renaming a Program

- Select  >  **Connectivity** > **HomeLink** on the Pilot Panel, then choose the device to be renamed.
- Press the  edit icon on the device details screen.
- Use the on-screen keyboard to edit the device name, then press **SAVE** to confirm, or **CANCEL** to return to the previous screen.

### Deleting a Program

- Select  >  **Connectivity** > **HomeLink** on the Pilot Panel, followed by the device to be removed.
- Press **DELETE** on the device details screen.
- The screen will prompt to confirm whether you wish to delete the selected device. Press **DELETE ALL** to confirm or **CANCEL** to return to the previous screen.

### Deleting All Programs

- Select  >  **Connectivity** > **HomeLink** on the Pilot Panel.
- The option to **DELETE ALL** will be available if two or more devices are

---



connected to your vehicle. Press it to continue.

3. The screen will prompt to confirm whether you wish to delete all connected HomeLink® devices. Press **DELETE ALL** to confirm or **CANCEL** to return to the previous screen.

# Vehicle Information

## Vehicle Identification Number

---



Select  >  **About Vehicle** on the Pilot Panel to view the VIN.

Contact your Lucid Customer Care for assistance if you are unsure of how to resolve an alert or notification.

## Direct Access to the Owner's Manual

---

You can access the Owner's Manual via the Pilot Panel under Settings. The Owner's Manual periodically updates with the latest information, as long as the vehicle has internet connectivity.

Select  >  **About Vehicle** on the Pilot Panel, then press the **OWNER'S MANUAL** button.



 **Note:** You can also view the Owner's Manual with the Lucid Mobile App.



## Alerts and Notifications

---

 **WARNING:** Read all vehicle alerts and notifications carefully and follow any provided instructions as soon as possible. Do not drive the vehicle if you are cautioned not to do so.

Important system alerts and notifications that appear on the Glass Cockpit will also be saved under the **About Vehicle** screen on the Pilot Panel for future reference.

Select  >  **About Vehicle** on the Pilot Panel to view any current alerts and notifications.



 **Note:** A dot on the  **About Vehicle** icon indicates a new alert or notification. The indicator will disappear once the alert or notification has been reviewed.

# Software Updates



## Updating Software

Your vehicle supports wireless software updates, giving you continued access to new features and improvements. Lucid recommends installing these updates as soon as they become available.

### Current Software Version

Select  >  **About Vehicle** on the Pilot Panel to view the current software version. Press **Learn More** next to a version to read the release notes.

### Prerequisites for Updates

- Your vehicle must be shifted into **P (Park)** before starting an update.
  - The vehicle battery must be charged to at least 20% before installation because some updates take a few hours to install. See [Charging the Vehicle](#) on page 183.
    -  **Note:** Charging is paused during the update installation process.
  - Ensure that your vehicle is connected to Wi-Fi® and has a strong signal in order to receive updates quickly and uninterrupted. See [Add a New Wi-Fi Network](#) on page 164.
  - You will not be able to lock or unlock the vehicle, access the screens, or drive during the update.
  - Guest Users are unable to install or schedule updates. See [About User Profiles](#) on page 139.
-  **WARNING:** All occupants must exit the vehicle before the update. Once the update starts,

you will not be able lock or unlock doors.

### Update Notifications

You should receive notifications in three ways when a software update becomes available:



1. A push notification will be sent to the Lucid Mobile app.

 **Note:** This notification will only be received if push notifications are enabled on your mobile device.



2. A notification will display on the Right Cockpit Panel when your vehicle is shifted into **P (Park)**.

The notifications will continue once per day at the start of the first trip of the day if the update is not installed within 24 hours from the first notification.

Press **REMIND ME LATER** to postpone the notification for 8 hours. Press **REVIEW UPDATE** to continue with the update process on the Pilot Panel.

3. A notification badge will appear on the  icon on the Pilot Panel. The badge will disappear  once the update is installed.

### View Available Update

Select  >  **About Vehicle** on the Pilot Panel. A notification badge will appear on the  **About Vehicle** icon if a software update is available. The update information, estimated installation time, and options will display.

## Schedule an Update

Press **SCHEDULE TIME** on the software update screen if you wish to start the update later. Updates can be scheduled up to 48 hours later:

1. Read the cautionary statement and press **CONFIRM** to consent to the update.
2. Select the time to start on the screen provided and press **SET TIME** to save.
3. Your scheduled date and time will display on the main software update screen and can be edited by pressing the  icon beside it. Ensure that all update prerequisites will be met at the scheduled time.

You will receive a notification on the Right Cockpit Panel 30 minutes before a scheduled update with options to **Delay an Hour** or **Cancel Schedule**.

## Install an Update Now

Press **INSTALL NOW** to proceed with the update on the software update screen.

1. Read the cautionary statement and press **CONFIRM** to consent to the update.
2. The system will perform a series of checks to ensure all prerequisites are met.
3. A 2-minute countdown will display. Exit and lock the doors at this time. See Doors on page 23.
4. The Pilot Panel and Left Cockpit Panel screens will be blank during the update. The Glass Cockpit will indicate that the update is proceeding. The progress can be viewed on the Right Cockpit Panel and within the Lucid Mobile App.
5. A notification will appear on the Left Pilot Panel and a push notification will be sent to the Lucid Mobile App when the update is complete.





Note: A notification will display on the Infotainment screens and a push notification will be sent to the Lucid Mobile App if an update fails to install:

- Resolve the issue and press **TRY AGAIN** if a failure is due to a prerequisite not being met, (e.g., battery was at less than 20% or vehicle was not put in Park).
- Contact a Lucid Service Center for assistance if the a failure is due to another reason.

### Viewing Release Notes

Lucid strongly recommends that all users read the release notes for every software update. They may contain important information about your vehicle, including safety information or new operating instructions.

Release notes can be viewed before and after a software update via the following methods:

- Select  >  **About Vehicle** on the Pilot Panel. The software versions for the current installation and any available updates will be listed. Press **Learn More** next to a version to read the notes for it.
- Press **Learn More** on the prompt that appears on the Right Cockpit Panel when an update has installed successfully.

08

# Mobile App



# Phone App

## Overview

Your **Lucid Air** mobile app is an extension of your **Lucid Air** ownership experience. Use the app to monitor your vehicle, adjust controls, or ready your car for a trip.

These are some things you can do with the mobile app:

- Locate the vehicle's precise location using maps. See Map Screen on page 175.
- Control the trunk, front trunk, door locks, and charge port door remotely.
- Adjust the cabin temperature, or turn on the defrost to get your car ready to go.
- Flash the lights, or honk the horn to locate your car in a crowded parking area.
- Start an OTA update.
- Check your vehicle battery level and get charging updates.
- Control certain car features with your Apple watch. See Apple Watch.
- Find charging stations, destinations, or trip routes and send directions to the in-car navigation. See Charging Screen on page 175.
- Access and view your car's Owner's Manual.

## Using the Mobile App

Follow the below steps to download and use the **Lucid** mobile app.

1. Download the Lucid mobile app to your phone from the app store.

2. Login to the app with your credentials.

 Note: Your credentials will be available at the time of vehicle purchase. Contact customer care for more information.

3. To pair your app with your vehicle, see Creating a User Profile on page 139.
4. Switch on your phone's Bluetooth and ensure that you are in a Wi-Fi zone.

Ensure that you are in an area with active cellular service to allow the mobile app to communicate with your vehicle.

 Note: Lucid recommends that you have a physical key readily accessible if parking in an area with limited/absent cellular service.

 Note: Your vehicle does not support the use of third-party applications to connect.

## Home Screen

### Home Screen Overview

The following buttons at the bottom of the home screen are present on all screens of the mobile app:

1. **Main Menu**

Lets you access the items on the main menu of your app.

2. **Vehicle Name**

The name used in the profile will be displayed here.

If the app is used to control more than one vehicle, pressing the vehicle name will display a drop-down list of available vehicles. Select the vehicle you wish to control with this app.

### 3. Mobile Key

Use this button to link a new mobile key.

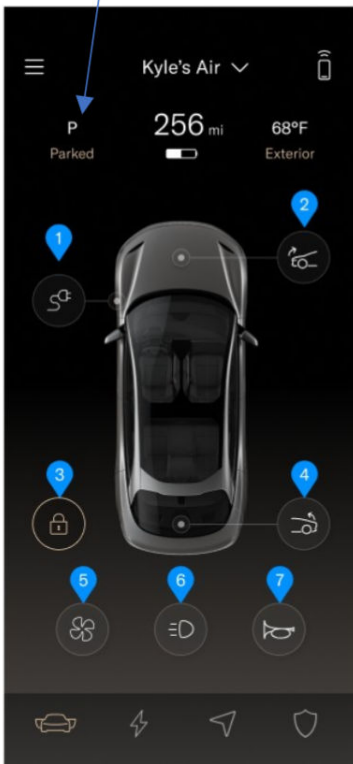

### 1. Open / Close Charge Port Door

If the charge port door is closed, pressing this button will open it. If the charge port door is open, pressing this button will close it. If a charge cable is connected to the vehicle, pressing the button will have no affect.

### 2. Open / Close Front Trunk

If the front trunk is closed, pressing this button will open it. If the front trunk is open, pressing this button will close it.

### 3. Door Locks

If the doors are locked, pressing this button will unlock them. If the doors are unlocked, pressing this button will lock them. You must confirm the unlock command before the doors unlock.

### 4. Open / Close Trunk

If the trunk is closed, pressing this button will open it. If the trunk is open, pressing this button will close it.

### 5. Cabin Preconditioning

Press this button to preheat or pre-cool the cabin, by setting the target cabin temperature. If the target temperature is lower than the interior temperature, the air conditioner will be used. If the target temperature is higher than the interior temperature, the heater will be used. Use the + or - buttons by the temperature setting to raise or lower the desired temperature. Pressing the **TURN ON** button will activate the operation. Pressing **TURN OFF** will cancel the operation.

The windshield defroster can also be controlled from this screen. Pressing the **DEFROST** button starts the windshield defroster. Pressing **DEFROST** again, or pressing **TURN OFF** will cancel the defroster.

To close the **Cabin Preconditioning** window, press the X in the upper left corner. Closing this window will not affect the status of the cabin preset operations.

### 6. Flash Lights

Pressing this button will flash the headlights and taillights. This is useful in finding your vehicle in a crowded parking lot.

7. **Honk Horn**

Press this button to honk the vehicle's horn. This is useful when you desire to draw attention to the vehicle.

Charging Screen

Open the charging screen using the ⚡ on your app. You can set the charge limit using the scroll button as per your driving preference.

Lucid Mobile App also allows you to select charger ID and activate it if the Plug & Charge fails.

 **Note:** Do not use Electrify America's app to activate the Plug & Charge.

Map Screen

Lucid Mobile App shows charging stations available around your vehicle. You can toggle between 2D, satellite map, and range spider. You can also perform a search using the search option.

Using the pull-up menu, you can check for real-time station charger availability. The Lucid app allows you to send directions with EV charging stops to the car.

Vehicle Health Screen

**Accessing the Vehicle Health screen**

1. Log into the Lucid Mobile app.
2. Click the  icon .

The following information is displayed:

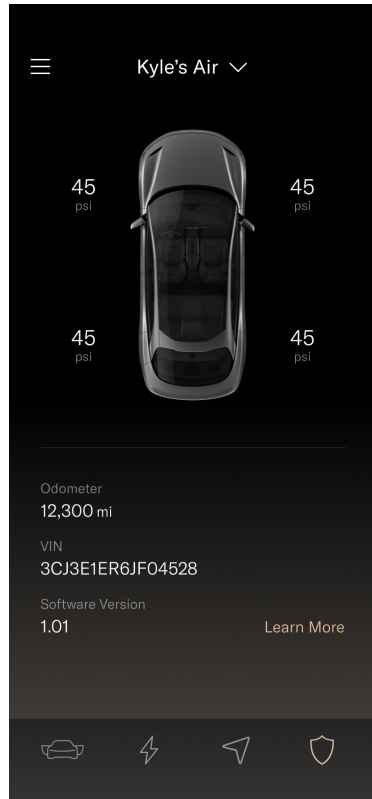

- Tire pressure of all four tires
- Software updates available for your vehicle. Tap to see applicable warnings and start installing updates remotely.

 **Note:** You can get the software updates via your Wi-Fi or cellular provider.

- View your vehicle Odometer readings
- Vehicle Identification Number (VIN) of your vehicle

---

# Watch App

## Apple Watch

---

Use your Apple watch to view and control some of the features of your Lucid car.

You can control the following features of your car from your Apple watch, if you are already signed in on your iPhone's mobile app:

1. Monitor live charging status and progress.



2. Remotely control-
  - a. Temperature inside the car (including defrost).
  - b. Opening and closing of the front trunk, and trunk.
  - c. Opening and closing of the charge port door.
  - d. Locking and unlocking of the vehicle doors.
  - e. Honking the horn, or flashing the lights.



3. Use Siri's integration of built-in/ custom commands.

 *Note:* You have to be logged into the Lucid mobile app on your iPhone to view or control any vehicle feature from your Apple watch.

 *Note:* All vehicle features on your Apple watch are synchronized with your iPhone.

09

# High-Voltage Battery Pack & Charging

# Electric Vehicle Components

## High-Voltage Components

- ⚠ **WARNING:** The high-voltage system in this vehicle has no user-serviceable parts. Do not disassemble, remove, or replace high-voltage components, connectors, or cables. High-voltage cables are colored orange for easy identification.
- ⚠ **WARNING:** In the unlikely event that a fire occurs, exit the vehicle and immediately contact your local fire emergency responders.
- ⚠ **WARNING:** For your safety, always read and follow the instructions and warnings written on all labels attached to your vehicle.

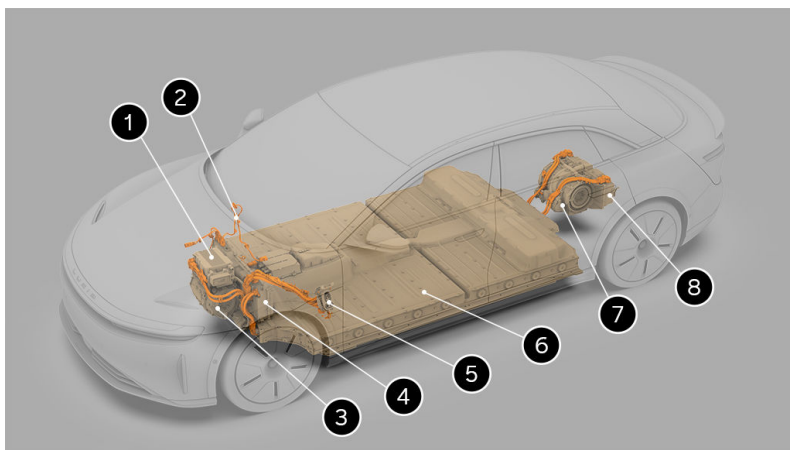

1. Front Inverter.
2. High-Voltage Cables (Not all High Voltage Cables are Shown)
3. Front Drive Unit
4. Wunderbox
5. Charge Port
6. Battery Pack
7. Double Rear Drive Unit
8. Double Rear Inverter

 This symbol can be found on high-voltage components and indicates a risk of electrical shock.

---

# Battery Information

## About the Vehicle Batteries

---

 **WARNING:** Only a Lucid Service Center should service the high-voltage battery pack. Improper handling can result in death or serious injury.

There are two types of batteries powering your vehicle: a high-voltage lithium-ion battery pack that powers the vehicle's electric powertrain motors and two 12V AGM batteries that power systems, such as the infotainment displays and safety systems.

 **ENVIRONMENTAL:** Recycle in accordance with local regulations.

## High-Voltage Battery Pack Care

---

### Storage Temperature

 **CAUTION:** Avoid exposing your vehicle to ambient temperatures above 113°F (45°C) or below -4°F (-20°C) for more than 24 hours at a time. Prolonged exposure can greatly reduce battery pack life and performance. If it is necessary to exceed these guidelines, whenever possible, plug the vehicle into a charging source to provide reliable thermal conditioning of the battery pack.

Extreme temperatures can damage the battery pack. Avoid parking in direct sunlight, especially on hot, sunny days, if possible. Lucid also recommends keeping your vehicle sheltered or parked in a garage whenever possible in extremely cold weather.

### Preserving High Voltage Battery Pack Health

The most effective way to prolong the battery, (when not driving), is leaving it plugged into a charging source. Setting

the charge level to **Daily** usage also helps preserve battery health.

 **CAUTION:** When the vehicle is not in use for long periods of time, it is necessary to plug it into a charging source and set the charge target to the minimum **Daily** value.

The battery pack gradually discharges over time when your vehicle is left parked and unplugged (as with all batteries).

 **WARNING:** If your vehicle reaches a 0% state of charge (or 0 miles/0 km range), charge the vehicle immediately. The vehicle must not remain at 0% state of charge for more than 24 hours, or permanent damage to the high voltage battery could result. Repair or replacement of the high voltage battery in these circumstances may not be covered by the New Vehicle Limited Warranty.

Battery pack life and performance are greatly improved by maintaining a healthy state of charge (generally between 40% and 80%).



The Glass Cockpit will show a yellow low battery indicator when the remaining battery pack charge falls below the 50 mi / 80 km range.

Warnings will display on the Glass Cockpit when the battery pack charge level falls below 10 mi / 16 km). Proceed to the nearest charging station as soon as possible to avoid a vehicle shutdown.

The Glass Cockpit will display a warning indicator when poor battery pack health is detected.

Battery pack performance degrades over time, as is normal with all lithium-ion



batteries. The Pilot Panel will display a warning when the battery pack needs service. Contact Lucid Customer Care to schedule a service appointment.

# Charging Instructions

## Safety Checklist

- ⚠ **WARNING:** If you have any concerns with the condition of a wall outlet, the charge port, or the charging cable, **DO NOT** use them. Seek assistance from a qualified electrician or a Lucid Service Center. Using charging equipment that is damaged or faulty may result in injury, death, or property damage.

Check the following items before charging your vehicle:

- Inspect the outlet if you are using a domestic wall outlet and do not use it if it appears damaged or worn.
- Inspect the charging cable and connector for damage, including frays or cracks. Do not use it if a part appears damaged.

 **Note:** Contact a **Lucid Service Center** if the Lucid Mobile Charging Cable is damaged.

- Ensure that the charging cable is fully uncoiled before use.
- Confirm that the charging connector and charge port are clean and unobstructed. Do not use them and contact a **Lucid Service Center** if you find any contamination or a foreign object in either part.
- Check to see that the charging cable and charge port are dry. Ensure your hands are dry, and that there is no water or other fluids in the surrounding area (such as puddles on the ground).





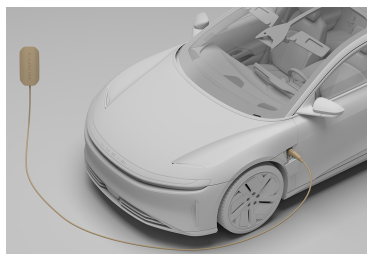

## Charge Port Door

The charge port door is located to the rear of the left front wheel.



## Opening and Closing the Door

Car doors must be unlocked for the charge port to open. You can open and close the charge port door using any of the following methods:

- Press the  **charge port icon** on the **Left Cockpit Panel**.
- Select  >  **OPENINGS** on the **Pilot Panel** and press the  **charge port icon**.
- Select  >  **CHARGING** on the **Pilot Panel** and press the **OPEN CHARGE PORT** button.
- Use the **Lucid Mobile App**.
- Press the bottom of the charge port door with a valid key fob detected within 6.5 feet (2 m) of the unlocked vehicle, and it will automatically open. The charge port door automatically closes after unplugging the charging cable; otherwise, you can gently push upward on the bottom of the door until automatic closing takes over.

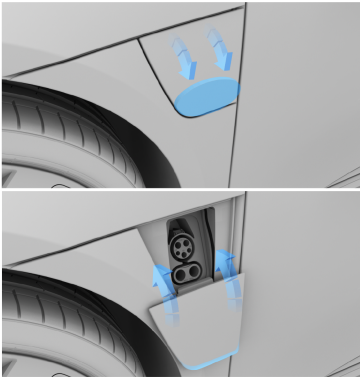

4. Insert your fingers into the gap once it is there along the top edge and gently pull downward until a hard stop is reached.

Charging the Vehicle

The Lucid Mobile Charging Cable is a convenient way to charge your Lucid vehicle at home or on the go. When not in use, it can be stored in the vehicle. See the **Lucid Mobile Charging Guide** and our website for instructions and additional details about this charger or charging alternatives.

Using the **Lucid Mobile Charging Cable**, plug the J1772 (CCS type 1) connector into the car's charge port to begin charging.

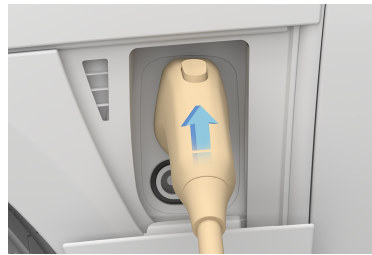

**⚠ CAUTION:** If the charge port door has iced over in cold weather conditions, DO NOT attempt to break the ice using blunt force, (hitting or chipping at it with a tool), as this could cause damage.

**✎ Note:** Lucid recommends using the in-vehicle controls or the Lucid mobile app if the charge port door has iced over to cycle the open/close function of the door, until the ice breaks.

**Manually Opening the Door**

**⚠ CAUTION:** Manually opening the charge port door is only recommended in instances where the vehicle has no power and the 12V batteries cannot be charged.

The charge port door can be manually opened if the vehicle has no power:

1. Open the driver's door.
2. Place your finger at the bottom right corner of the charge port door and gently lift it up.
3. Continue lifting on the corner until a gap begins to form between the top edge and the fender.

**⚠ CAUTION:** Lucid recommends to not use adaptors between the charge cable connector and the vehicle charge port. Some chargers can produce electrical current higher than the rated limits of many adaptors. Using an adaptor that is not rated for the current produced may cause excessive heat and damage the charge port. For further assistance, see Contacting Lucid Motors on page 254.

**✎ Note:** The battery system's heating and cooling functions monitor the temperature of the battery pack during charging, and will turn on or off as needed to help maintain an ideal temperature. Clicking or fan noises are normal.

---

## Errors During Charging

The charge port light will turn red if an error occurs. Details and instructions will display on both the Pilot Panel and Glass Cockpit if this happens.

Contact **Lucid Customer Care** for further assistance if following the displayed steps does not resolve the error.

RangeXchange™

---

 **Note:** RangeXchange may not be available in all regions.

If another Electric Vehicle is low on charge, you can use your **Lucid** vehicle to charge it through shared charging.

### Setup

1. Connect the RangeXchange cable to the Mobile charger.



2. Connect the short end of the RangeXchange cable to your vehicle.

The charge port light will flash blue.

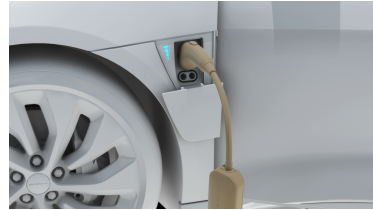

3. Plug in the long end of the RangeXchange cable to the other vehicle.

This step is the same as the AC charging behavior of the other vehicle.

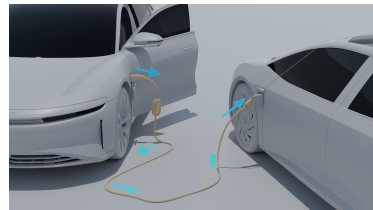



4. Start the charging process via the Pilot Panel of your vehicle.

### Start a session from the Pilot Panel

1. Once the Mobile charger is connected to your vehicle via the RangeXchange adapter, the Pilot Panel will display the RangeXchange discharge screen.
2. To start discharge from your vehicle, tap **Start Sharing**.
3. After the connection is established, you can charge the other vehicle.
4. Your vehicle will continue to discharge until the set limit has been reached.

### Discharging Speed and Power Limits

Your vehicle can support upto 9.6 kW of power discharge.

-  Note: To reserve some charge for your vehicle, tap the **Set Limit** and move the slider on the Pilot Panel to adjust the minimum discharge limit.
-  Note: If your charging does not begin within 5 minutes, the charging session will stop. You will have to re-initiate the session from the Pilot Panel.
-  Note: To stop a discharge session, tap **Stop Sharing** on the Pilot Panel.

Disconnecting the Charging Cable

Press the button and then pull the charging cable towards you to disconnect it from the charge port and stop a charging session.

-  Note: The vehicle cannot be driven when the charging cable is connected to the charge port. A notification will appear on the Glass Cockpit if you attempt to shift out of **P** (Park).

**Emergency Manual Charging Cable Disconnect**

-  **CAUTION:** Manually releasing the charging cable is only recommended in instances where the charging cable button will not release it from the charge port.

The vehicle has a manual disconnect if pressing the button on the charging cable does not release it:

1. Open the hood. See Hood Opening and Closing.
2. Pull up on the manual disconnect lever to release the charging cable.

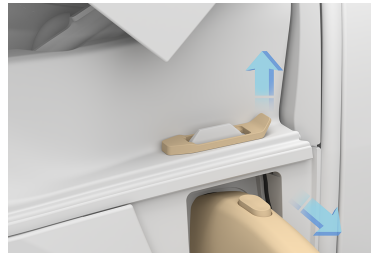

3. Ensure that the manual disconnect lever is correctly inserted into its original position before closing the hood.

Charging Status

You can check the progress of the charging process via the light on the charge port, in-vehicle displays, or Lucid Mobile App.

**Charge Port Light**

The charge port light indicates the current charging status. Refer to the following table to understand the meaning of each light color and pattern:

Color	Definition
<b>White (Solid)</b>	<b>Ready to Charge</b>
<b>White (Flashing)</b>	<b>Charging Pending</b>
<b>Green (Flashing)</b>	<b>Charging in Progress</b>
<b>Green (Solid)</b>	<b>Charging Completed</b>
<b>Red (Solid)</b>	<b>Charging Error</b>

The progress meter of the charge port light will flash green when charging, indicating the current charge level of the battery pack.

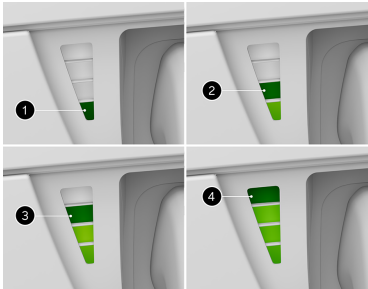

1. One LED 0% - 24%
2. Two LEDs 25% - 49%
3. Three LEDs 50% - 74%
4. Four LEDs 75% - 99%

When charging is completed, the light will remain solid green.

### Vehicle Display Status

The Pilot Panel and Glass Cockpit will display the current charging status once charging begins, including the time remaining until completion.

### Glass Cockpit charging display



### Setting a Charge Limit

**⚠ CAUTION:** Charging beyond the recommended level too often can cause premature battery pack degradation.

The charging system will charge the battery to the recommended level without a set charge limit. The vehicle dynamically adjusts the actual charging rate depending on the state of charge, ambient temperature, battery pack

temperature, and position of the charge slider.

You may need to adjust the charge limit higher or lower, according to your driving needs. A higher charge limit will increase trip distance. Vehicles that are parked for extended periods should be plugged in and use a lower charge limit to maintain battery pack health.

Follow these guidelines for setting the charge limit:

- Set the slider to **Daily** or 50% - 80% for general use. This setting best preserves the battery pack life.
- Set the slider beyond **Daily** and up to **Distance** for more range. **Distance** allows a full charge.

You may notice changes in reduced regenerative braking and charging speeds when charging beyond the **Daily** setting. This functionality gradually returns as the car is driven.

To set the charge limit:



1. Select > **CHARGING** on the Pilot Panel to display charging options.
2. Tap the **SET CHARGE LIMIT** button.
3. Use the slider to set the desired level of charge between 50% - 100%. Set the slider to **Daily** for general use and **Distance** for a long-range trip.
4. Tap the **DONE** button.

You can set a State of Energy (SOE) limit between 50% and 100%. If the battery level at plug-in is below the set limit, the vehicle will display **charging complete**. Adjust the limit anytime, even if the SOE is above the new limit. A reminder will appear on the main screen if the set limit is lower than the current SOE.

### Preconditioning

Preconditioning optimizes the temperature of the battery so it receives

the maximum amount of charging from a fast charging station. Your Lucid Air can precondition your battery before fast charging. Start preconditioning about 20 minutes before you intend to plug in to a fast charging station. To start preconditioning:

1. Select  >  **CHARGING** on the Pilot Panel to display charging options.
2. Tap the **START PRECONDITIONING** button.

Your vehicle will start optimizing the battery temperature en route to the charging station. If you arrive at the charging station before preconditioning is complete, you can still plug in and charging will begin automatically.

 **Note:** Preconditioning is not required for home charging (AC charging) since the energy level is low enough that the temperature of the battery does not affect the charging rate.



Scheduled Charging

**Scheduled Charging**

Scheduled Charging allows you to pick a time when charging will start, even after the charging cable is connected. This can be late at night or during a particular time of day.

 **WARNING:** Lucid recommends always using the built-in Scheduled Charging feature. The Scheduled Charging application on third-party chargers may not work properly on your vehicle. For further assistance, see Contacting Lucid Motors on page 254.

**Scheduling a Charging Session**

Schedule a charging session on the Pilot Panel by tapping  >  **CHARGING**. The Scheduled Charging option will appear at the bottom of the display.

To set up scheduled charging, select the location and time for charging to begin.

When plugging in, the vehicle must be within 200m of the selected location for charging to be scheduled.

 **Note:** Charging can be scheduled only on non-digital (J1772) AC chargers.

After charging is scheduled, "charging scheduled" will appear on the glass cockpit and the pilot panel. Charging will begin at the selected time.

 **Note:** Unplug and plug the charging cable again to schedule another charging session once charging has begun.

**Charging Schedule and Flexibility**

Charging will be automatically scheduled to start at the designated time when you connect your vehicle to an AC charger located within a 200m radius of the specified location. If you happen to plug in your vehicle after the scheduled time, charging will commence immediately. This grace period lasts for a maximum of 12 hours following the scheduled time. For example, if you have set the scheduled time for 9:00 PM and you arrive home after having dinner at 10:00 PM, the charging process will start immediately upon plugging in at 10:00 PM. However, if you return from lunch at 2:00 PM and connect your vehicle, the charging will be scheduled to begin at 10:00 PM.

**Turning Scheduled Charging On and Off**

Tap the toggle to the right of your selected charging time on the Pilot Panel to turn Scheduled Charging on or off.

 **Note:** Your vehicle will start immediately charging when a charging cable is connected and Scheduled Charging is off.

---

## Selecting a New Scheduled Charging Time

Tap the scheduled time on the Pilot Panel to modify it. A Scheduled Charging modal will appear where you can select a new time and location. Tap Confirm.

## Overriding a Scheduled Charging Session

Tap Start Charging on the charging screen on either the Pilot Panel or in the Lucid Mobile App if Scheduled Charging is active to override the scheduled time and begin immediately charging.

 **Note:** This will only override the current Scheduled Charging session. The feature will continue to function as normal for all future sessions.

---

### Cold Weather Charging Considerations

 **CAUTION:** Do not expose your vehicle to extreme temperatures for long periods without driving or connecting to a charging cable, as this can negatively affect battery pack life. When temperatures are below 41°F (5°C) and you are not driving your car, connect to a charging cable.

You may experience a range reduction in very cold weather. The Pilot Panel will automatically switch to the  **CHARGING** screen and display the reduction and remaining range.

 blue battery warning indicator will display on the Glass Cockpit when the battery pack is too cold and needs to reserve energy.



10

# Maintenance

---

# Maintenance Requirements

## Your Responsibility

---

The safety, reliability, and performance of your vehicle depends partly on how well it is maintained. Maintenance is an owner's responsibility, and you must ensure appropriate vehicle upkeep according to Lucid's recommendations.

## Scheduled Maintenance

---

Your vehicle will display a message on the Glass Cockpit when the annual scheduled maintenance is due.

**Lucid** recommends entrusting a **Lucid Service Center** to perform the majority of the regular servicing and maintenance of your vehicle. **Lucid** Service Centers have the specialized knowledge and equipment necessary to ensure the best possible service and care for your vehicle.

## Fluid Replacement

---

**Lucid Service Centers** will replace the necessary fluids in your vehicle during regularly scheduled service intervals.

## Owner Maintenance

---

 **WARNING:** Some fluids used in electric vehicles are poisonous and should not be ingested or brought into contact with skin. These fluids include brake fluid, battery acid, battery coolant, and windshield washer additives. Always read and obey all instructions printed on fluid container labels.

 **WARNING:** Any significant or sudden drop in fluid levels should be immediately rectified to avoid dangers of isolation loss from coolant leaks that can lead to fires.

 **WARNING:** As the driver, it is your responsibility to maintain correct tire pressure and immediately rectify low tire pressure or uneven tire wear to avoid compromised tire performance and lifespan, or a flat tire.

In addition to scheduled maintenance performed by **Lucid**, you must carry out a few simple checks more frequently. Details are provided in the remainder of this section.

## Daily Checks

- Look for fluid deposits underneath the vehicle that may indicate a leak.

 **Note:** A small puddle of water may collect under the vehicle if the air conditioning has been running. This is normal.

- Check the charge level of the battery displayed on the Glass Cockpit. See Battery State of Charge Indicator on page 72.
- Check the operation of the seat belts, horn, wiper and washer, turn signals, and all exterior lights.
- Check the operation of the brakes and ensure that the parking brake automatically engages when the vehicle is in **P** (Park).

## Monthly Checks

- Check the windshield washer fluid level and top it off, if needed. See Checking Windshield Washer Fluid on page 195.
- Turn on the air conditioning to ensure that it is working properly.

See Temperature Control on page 98.

- Check the pressure, wear, and condition of each tire. Check the vehicle mileage to determine whether the tires are due to be rotated. See Maintaining Tire Pressures on page 215.

 **WARNING:** If you discover abnormalities during these checks, such as uneven tire wear or an unexpected drop in fluid levels, contact Lucid immediately.

### Before and After High-speed Driving

Before and after driving your vehicle at speeds exceeding 100 mph (161 kmph), check the following:

- Check tire pressures. See Tire Pressures at High Speeds on page 220
- Visually inspect strakes (vertical fins on rear underbody) for damage or misalignment. Damaged strakes may affect your vehicle's high-speed performance and stability. Damage can be corrected by your **Lucid Service Center**.

### Electrical and High Voltage Safety

 **WARNING:** Always disconnect the charging cable before working underneath the vehicle or the hood, regardless of whether or not it is charging. See Disconnecting the Charging Cable on page 185.

 **WARNING:** Some cooling fans operate even when the vehicle is powered off. Keep hands, hair, clothing, and tools clear of the fan blades at all times.

Although your vehicle was built with you and your occupants' safety as first priority, it is important to be aware of the risk of injury associated with high-voltage systems and to protect yourself, accordingly.

 **WARNING:** Read and follow the directions on all of the safety labels attached to the vehicle.

 **WARNING:** There are no user-serviceable parts in your high-voltage system. Do not attempt to access the high-voltage system or disassemble, remove, or replace any system components. All high-voltage cables are colored orange for easy identification.

 **WARNING:** Never touch any high-voltage cables, connectors, or components connected to the cables in the event a high-voltage cable or component becomes damaged. There is a risk of fatal injury by burning and electrocution if the system's high voltage is still active.

 **WARNING:** In the event of a collision, never touch any high-voltage wiring, connectors, or components connected to the wiring, even if you think the vehicle may not be powered on. There is a risk of fatal injury by electrocution if the system's high voltage is still active.

 **WARNING:** Immediately evacuate the vehicle and contact your local fire emergency responders if a vehicle fire occurs, as they possess the proper training and equipment to safely extinguish fires in electric vehicles.

---

Maintenance Schedule

---

The scheduled maintenance or service must be performed in accordance with the chart below to keep your vehicle in top operating condition.

The service intervals in this maintenance and service schedule are based on average driving conditions. Some items will need more frequent service if you drive in unique conditions, such as unusually wet or dusty areas. Consult your **Lucid Service Center** for recommendations applicable to your individual needs and usage.

 **Note:** Bring your charging cable and all key fobs with you to every service appointment to be checked during the multi-point inspection.

Maintenance Items	Every 1 year or 12,000 miles (19,300 km)	Every 2 years or 24,000 miles (38620 km)	Other
Multi-Point Inspection	•		
Tire Rotation and Tire Balance (19-Inch Wheels Only)	•		
Cabin Air Filter Replacement	•		More Often Under Unique Conditions
Brake Fluid Replacement		•	More Often Under Unique Conditions
Key Fob Battery Replacement	•		
Sun Visor Battery Replacement	•		
Wiper Blade Replacement	•		
Air Conditioning Performance Check		•	
Battery Health Check		•	
12V Battery Replacement			Every 4 Years or 48,000 Miles (77250 km)
Tire Repair Sealant Replacement			Every 5 Years or 60,000 Miles (96560 km)
Coolant Check			Every 3 Years or 36,000 Miles (58000 km)

## Multi-Point Inspection

Your vehicle should be given a full multi-point inspection service every 12 months or 12,000 miles (19300 km) (whichever comes first).

 **Note:** A message will display on the Glass Cockpit to remind you to service your vehicle.

This service includes inspections and checks the following systems:

- Steering Alignment
- Battery (12V) Condition
- Battery Pack (HV) Condition
- Coolant Condition
- Brake Fluid Condition
- Brake Rotors and Pads Wear
- Chassis Bolts Torque
- Closures (Doors, Hood, and Trunk) Operation
- Condenser (Check for Debris)
- Electronic Parking Brake Operation
- Heating, Ventilation, and Air Conditioning Operation
- Horn
- Interior and Exterior Lights
- Key Fob Operation
- Seat Belts Operation
- Tire Pressure and Tire Wear
- Visual Signs of Fluid Leaks
- Wipers and Washers
- Charging System and Charging Cable

## - Firmware

Your vehicle will also be given a road test to inspect its current driving condition (such as pedal operation, vehicle handling, and steering alignment), and to check for any abnormal operational noises.

 **WARNING:** Your vehicle is equipped with two 12V batteries. It is critical that the 12V batteries are replaced **ONLY** with identical parts or parts approved by Lucid. Failure to do so could put safety of the vehicle and occupants at risk.

 **CAUTION:** Due to the location of the batteries, Lucid recommends that replacement of these batteries is only carried out by a **Lucid Service Center**.

# Fluid Reservoirs

## Checking Brake Fluid

### Low Brake Fluid Warning Indicator

If the fluid in the brake reservoir drops below the recommended level, the brake warning icon will be displayed on the Glass Cockpit. This will be accompanied by a notification message.

- WARNING:** If the low brake fluid notification displays while driving, stop as soon as safety permits by gently applying the brakes. Do not continue driving. Immediately contact a Lucid Service Center.

### Checking the Fluid Level

Check the brake fluid level with the vehicle on level ground.

1. Remove the under hood rear apron.
2. Remove the brake reservoir cover.

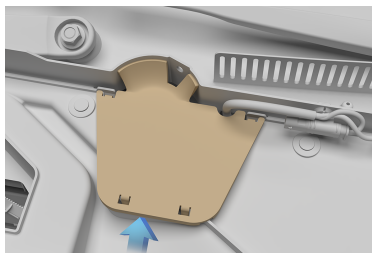

3. Check the fluid level visually by looking at the outside marks on the side of the reservoir without removing the filler cap.

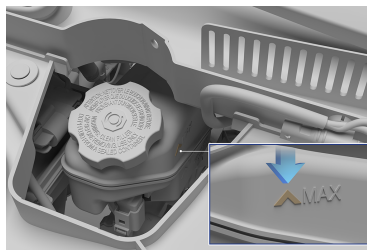

The brake fluid level should always be between the **MIN** and the **MAX** marks.

- Note:** Although the brake fluid level slightly drops during normal use as a result of brake pad wear, it should not drop below the **MIN** mark. Excessive or frequent fluid loss may indicate a leak in the system.

### Topping Off Brake Fluid

- WARNING:** Only use new fluid from a sealed, air-tight container. Never use previously used fluid or fluid from a previously opened container. Excess moisture in the brake fluid can cause a dangerous loss of braking efficiency.
- WARNING:** Brake fluid is highly toxic. Keep containers sealed and out of the reach of children. If accidental consumption of brake fluid is suspected, seek immediate medical attention.
- WARNING:** Do not allow brake fluid to come into contact with your eyes. If this happens, flush your eyes with clean water for at least 15 minutes and seek immediate medical attention.

To top off the fluid:

1. Clean the filler cap before removing it to prevent dirt from entering the reservoir.
2. Unscrew the cap and remove.
3. Fill the reservoir to between the **MIN** and the **MAX** marks using a clean funnel and brake fluid meeting specification DOT4.
4. Install the reservoir cap.

**⚠ CAUTION:** Brake fluid will damage painted surfaces. Immediately soak up any spills with an absorbent cloth and wash the affected area with a mixture of car shampoo and water.

freeze on contact with the windshield, impairing visibility.

**✎ Note:** Some national or local regulations restrict the use of Volatile Organic Compounds (VOCs). VOCs are commonly used as antifreeze in washer fluid. Use a washer fluid with limited VOC content only if it provides adequate freeze resistance in all the climates where you drive.

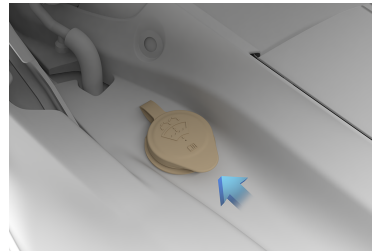

### Replacing Brake Fluid

The brake fluid should be replaced every 2 years or every 24,000 miles, whichever comes sooner.

#### Checking Windshield Washer Fluid

Check the level of the windshield washer fluid monthly, or more frequently if you use it often.



An indicator will display on the Glass Cockpit if the quantity of fluid remaining in the washer reservoir drops below the recommended level. This is accompanied by a notification message.

Periodically operate the washers to ensure that the nozzles are clear and properly directed. See Cleaning Washer Jets on page 197 if a washer jet performs poorly.

### Topping Off Windshield Washer Fluid

**⚠ WARNING:** In temperatures below 4°C (39°F), use a washer fluid with deicer. In cold weather, using a washer fluid without deicer can cause the fluid to

1. Clean the filler cap before opening it to prevent dirt from entering the reservoir.
2. Open the filler cap.
3. Fill the reservoir until the fluid is visible just below the filler neck.
4. Close the filler cap.

**⚠ CAUTION:** Washer fluid can damage painted surfaces. Immediately wipe up any spills with an absorbent cloth and wash the affected area with water.

---

# Wiper Blades and Washer Jets

---

## Checking the Wiper Blades

---

- ⚠ **CAUTION:** Only use cleaning products that have been approved for use on automotive glass and rubber. Inappropriate products may cause damage, smearing, or increased glare on the screen.

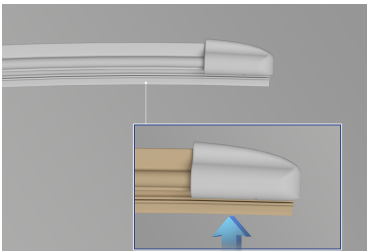

You should periodically check and clean the wiping edge of the wiper blade. Clean the blade edge using a soft cloth or sponge, and isopropyl (rubbing) alcohol or windshield washer fluid. Also, check the blade rubber for cracks, splits, or roughness. Immediately replace the blade if any damage is found, to prevent damage to the glass.

---

## Replacing Wiper Blades

---

- ✎ **Note:** Replace the wiper blades at least every year for optimum performance.

The life expectancy of wiper blades can vary, depending on the geographical area and frequency of use. Poor wiper blade performance may result in chattering, skipping across the glass, leaving behind marks, streaks of water, or wet spots. Clean the wiper blades or replace them, as needed, if any of these conditions are present.

---

## Replacing the Front Wiper Blades

- ⚠ **CAUTION:** Only install wiper blades that are the same length and identical to the original specification. Failure to do so may cause poor performance and damage to the wiper system.

1. Open the hood. See Hood Opening and Closing.
2. Lift the wiper arm away from the windshield.
3. Depress the locking tab while sliding the wiper blade away from the arm and remove it.

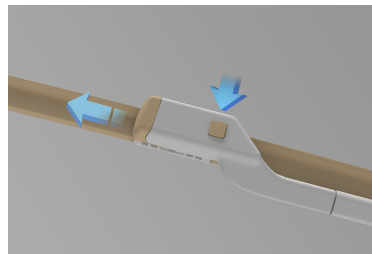

4. Installing a new wiper blade involves the reverse procedure of removing it. You should be able to hear and feel it click into place on the wiper arm.
5. Gently lower wiper blade back on to the windshield.

- ✎ **Note:** Contact your nearest **Lucid Service Center** to order new wiper blades.



---

## Cleaning Washer Jets

---

- ⚠ WARNING:** Do not operate the washer jets during cleaning. Windshield washer fluid may cause irritation to the eyes and skin. Always read and observe the washer fluid manufacturer's instructions.

It is easier to clean the washer jets by first opening the hood because they are located on the wiper arms. See Hood Opening and Closing.

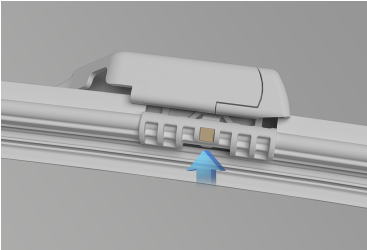

If a washer jet nozzle's performance may decrease if it becomes clogged with debris or build-up. There are several methods for removing any blockage:

- Dip a small, soft-bristled brush (such as an old toothbrush), in warm water and scrub it in and around the nozzle to clear away any dirt or debris.
- Use a can of compressed air to blow a concentrated stream of air into the clog to loosen any dirt or debris and to blow it away from the nozzle.
- For more serious clogs, slide a thin piece of wire into the nozzle to clear any blockages.

---



# Cabin Air Filter

## Replacing the Cabin Air Filters

---

Your vehicle has two installed cabin air filters that prevent pollen, industrial fallout, road dust, and other particles from entering the vehicle via the vents.

The cabin air filters should be replaced every year or every 12,000 miles (19,310 km), whichever comes first. Failure to replace the air filters will result in reduced air flow into the vehicle.

-  *Note:* It is suggested to change the filters prior to pollen season to gain the maximum benefit of the cabin air filters.
-  *Note:* The air filters may require replacement more frequently if you operate your vehicle in an environment where there is more dust or sand in the air.

# Wheels

## Seasonal Tire Changes

Your **Lucid Air** may use 21" summer tires and 19" winter tires. Several vehicle systems rely on knowing the wheel size, so a system update is required whenever swapping wheels of different sizes.

### Wheel Swap Preferred Method: Lucid Service Center

If possible, it is best to schedule your wheel swap with a **Lucid Service Center**. They will complete the entire procedure for you, including making the physical swap, resetting the TPMS, and updating the vehicle software to recognize the new wheel sizes.

### Swapping the Wheels Yourself

Depending on where your seasonal tires are stored, you may find it more convenient to perform the swap yourself. After you swap the wheels, must reset the TPMS and update the vehicle software. You may do this yourself by following the prompts on the Pilot Panel or schedule a visit with **Lucid Service Center** to complete the procedure.

**⚠ WARNING:** When lifting your vehicle, make sure you follow all jacking safety instructions.

**✎ Note:** There is no danger driving the vehicle after swapping wheels but before updating vehicle software. However, you may notice minor dependencies with some systems such as a slightly inaccurate speedometer and odometer.

## Wheel Covers

The wheel covers of your **Lucid Air Sapphire** must be removed before track activities to ensure proper brake cooling.

### Removing Air Sapphire Two-Piece Wheel Covers

Your **Lucid Air Sapphire** wheel covers are a two-piece design. The carbon discs are attached to the wheel using a custom central fastener.

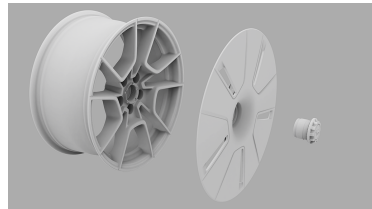

1. Locate the wheel cover removal socket. Place it on the central fastener.
2. A breaker bar or large socket wrench with a 1/2" square drive is required to break the nut loose, turning counter-clockwise.

**⚠ CAUTION:** Do not use an impact wrench as it may damage to the appearance of the nut.

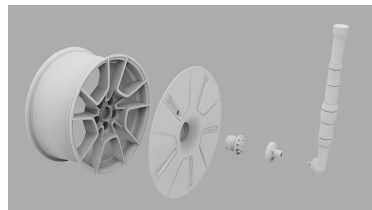

3. Unscrew the fastener and remove.
4. The carbon disc can now be pulled free from the wheel.

5. Wheel inserts can now be installed, if desired.

The removed wheel covers can be stored away for later re-installation, if desired. Clean the removed parts prior to storage for ease of handling when re-installing.

### Installing Air Sapphire Two-Piece Wheel Covers

1. Place the carbon disc against the wheel.
2. The disc might have to be slightly rotated for the tab on the disc to align with a slot on the wheel.

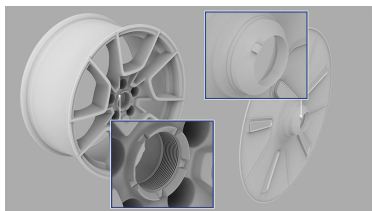

3. Screw in the custom central fastener by turning clockwise.
4. Torque wheel hub to 150Nm +/- 25Nm.

**⚠ CAUTION:** Ensure the wheel cover is fully seated to the wheel face prior to torquing the central fastener.

### Wheel Inserts

Your **Lucid Air Sapphire** also comes with wheel inserts which can be installed when the wheel covers are not in use.

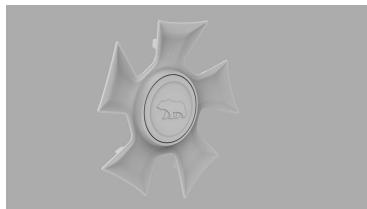

### Installing Air Sapphire Wheel Inserts

1. Align the geometry of the wheel insert with the structure of the wheel.
2. Press firmly into the wheel until it becomes fully seated.
3. The insert is fully seated when it sits below the surface of the wheel structure.

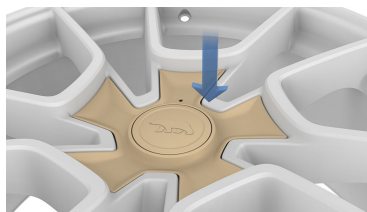

### Removing Air Sapphire Wheel Inserts

1. Use the wheel insert removal tool. Slot the hook of the tool into the hole on the wheel insert and pull along the wheel axis.

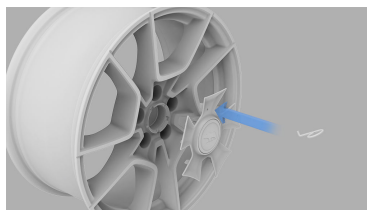

2. Significant force may be required to remove the wheel insert.

# Vehicle Care

## Cleaning the Exterior

- ⚠️ **WARNING:** Never charge your vehicle while washing it. Unplug the charging cable and close the charge port cover. Liquids entering the charge port while the cable is plugged in could result in serious personal injury, as well as damage to the vehicle, charging equipment, or property.
- ⚠️ **WARNING:** After washing the vehicle, wet brakes can result in longer stopping distances. To dry the brakes, slowly drive the vehicle while gently pressing the brake pedal a few times to warm up the brakes.

Your vehicle should be regularly washed to preserve the finish and maintain its overall appearance.

Wash your vehicle as soon as possible to protect the paint surfaces in the following scenarios:

- Wash your vehicle when mud, dust, soot, or dirt builds up on the surface.
- Wash your vehicle after driving on coastal roads or winter roads treated with salt.
- Wash your vehicle when corrosive contaminants, such as tree sap, bird droppings, or bugs, collect on the surface.
- Wash your vehicle after a rainfall to prevent possible damage from acid rain.
- 🌿 **ENVIRONMENTAL:** It is illegal to pollute drains, rivers, and waterways. Some cleaning products contain chemicals that are hazardous to the environment. Used toxic chemicals must be disposed of at

authorized waste disposal sites, only. Always take precautions to prevent fluids from spilling.

## Hand Washing

- ⚠️ **CAUTION:** Avoid using rough or tightly-napped cloths (such as washing mitts) on the vehicle, as these can be abrasive enough to damage the finish.
- ⚠️ **CAUTION:** Avoid washing your vehicle in direct sunlight. Water and cleansers dry faster on a hot surface and can leave water spots or stains.

Observe the following steps when washing your vehicle by hand:

- First, rinse the entire vehicle to remove as much excess dirt and dust as possible and reduce the risk of scratches from washing.
- Wash the vehicle using a clean, soft cloth or sponge and cold or lukewarm water mixed with a mild car soap.
- Rinse your cleaning tools often to avoid rubbing debris into the finish, especially if your vehicle is exceptionally dirty.
- Do not aim water hoses directly at windows, doors, or hood seals, or through wheel apertures onto brake components.
- Thoroughly rinse the vehicle with clean, cool water (after cleaning), until all soap is removed.
- Thoroughly dry the vehicle with a chamois or cotton cloth to avoid leaving water spots on the finish.

---

## Removing Tar Spots

- ⚠ **CAUTION:** Do not use acidic, abrasive, or petroleum-based cleansers, as these can damage the vehicle's paint and the plastic or metal parts.

You may use denatured alcohol to remove tar spots and stubborn grease stains from paint.

Immediately wash the area with soapy water after cleaning to remove the alcohol.

## Automatic Car Washes

- ⚠ **CAUTION:** Do not use a car wash that applies cleansers containing acid. Acid can react with the plastic in some vehicle components and damage them. Always check with your car wash to confirm that acid is not used.
- ⚠ **CAUTION:** Leave the windshield wipers in the off position while in a car wash to avoid damaging them.

**Lucid** recommends using only touch-free automated car washes that do not bring brushes or other cleaning tools in direct contact with the vehicle body.

- ✎ **Note:** Vehicle or paint damage caused by using an automatic car wash are not covered under the vehicle warranty.

## Pressure Washers

- ⚠ **CAUTION:** Do not use a pressure washer with a circular jet or bristle attachment, as it could damage the surface finish of components.
- ⚠ **CAUTION:** If improperly used, pressure washers that have a pressure exceeding 1,200 PSI (82 bar) can damage or even remove vehicle paint.
- ⚠ **CAUTION:** Do not use a hot or steam pressure washer with

a temperature exceeding 120°F (48°C), as this could remove paint and surface protection from exterior parts.

- ⚠ **CAUTION:** Keep the nozzle at least 12 inches (30 cm) from the surface of the vehicle. Always keep the nozzle moving and do not concentrate the spray on a single area.

- ⚠ **CAUTION:** Do not aim the pressure washer at any of the following:

- Door and Window Seals
- Roof Seals
- Ventilation Intakes
- Plastic Trim Components
- Electrical Components
- Exterior Cameras or Sensors (see DreamDrive Component Locations)
- Tires and Brake System Components

- ✎ **Note:** Vehicle or paint damage caused by using a pressure washer are not covered under the vehicle warranty.

## Underbody Maintenance

If salt has been used on the roadways (such as during winter months), thoroughly remove all traces of road salt. Use a hose to rinse the salt from the underside of the vehicle.

Flush away accumulations of mud in areas where debris easily collects (such as wheel arches and panel seams).

## Wheels

- ⚠ **CAUTION:** Do not use chemical-based wheel cleaners, as these can damage the finish of the wheel.

Wash the wheels with warm, fresh water containing a good quality wash and wax shampoo. Thoroughly rinse the wheels to remove any soap residue.

### Windshield, Windows, and Mirrors

-  **CAUTION:** Mirror glass is particularly susceptible to damage. Do not use abrasive cleaning compounds.





You should regularly clean all windows inside and out using a window cleaning solution. An automotive glass cleaner is recommended.

Clean the outside of the windshield with glass cleaner after washing your vehicle with washing or waxing products.

### Wiper Blades

You should clean wiper blades using isopropyl (rubbing) alcohol or windshield washer fluid. Do not use petroleum-based cleaners.

#### Polishing, Paint, and Body Repairs

-  **CAUTION:** Always wash your vehicle before waxing or polishing.
-  **CAUTION:** Do not polish or wax your vehicle in direct sunlight.
-  **CAUTION:** Do not use wax or polish containing any harsh abrasives, cutting compounds, or cleansers that may damage the vehicle finish. If in doubt when choosing a product, contact Lucid for recommendations.
-  **CAUTION:** Carefully read and follow all of the instructions provided by the manufacturer of the wax or polish product.

Regular waxing helps protect the paint surfaces from harsh elements and maintain their appearance. **Lucid** recommends polishing your vehicle before reapplying wax after the first year.

Polishing removes built-up residue and keeps the surface of the finish even.

The exterior paint should be regularly checked for damage. Any minor scratches or chips should be repaired as soon as possible using touch-up paint. Contact Lucid for recommendations.

Body repairs should only be performed by a body shop approved by **Lucid**. Contact a **Lucid Service Center** for assistance in locating an approved body shop near you.



#### Using a Car Cover

Use a car cover to preserve the cosmetic appearance of the body when the vehicle is not being used.

-  **CAUTION:** Never use a car cover when the vehicle is plugged in, as this can prevent the battery from being adequately cooled during charging.

#### Cleaning the Interior

### General Cleaning

-  **WARNING:** Exposure to chemicals in some cleaners can be hazardous and can irritate eyes and skin. Always read and follow the manufacturer's instructions when using cleaning products.
-  **WARNING:** Do not splash or spill liquids in the vehicle, as this could cause an electrical component to malfunction or catch fire. Any spills should be immediately wiped up using a clean, dry cloth.
-  **CAUTION:** Do not apply cleaning products directly to the surface being cleaned. Instead, apply non-solvent-based cleaning products to a soft cloth and then apply it to the surface being cleaned. Cleaning products entering into components may cause damage or impair their function.

-  **CAUTION:** Avoid using solvents (including alcohol), bleach, citrus, naphtha, or silicone-based products or additives on interior components, as these can damage the appearance of the material.

Inspect and frequently clean the interior to maintain the look and appearance of the interior of your vehicle.

It is recommended for general cleaning that materials and surfaces be cleaned using a non-solvent based cleaning (wet) wipe and dried with a microfiber cloth.

If possible, try to wipe up spillages and clean marks as soon as they occur. This will reduce the need for more extensive cleaning in the future.

-  **Note:** It is advised that you test all cleaners on a concealed area before use.

### Interior Glass and Mirrors



-  **CAUTION:** Do not scrape surfaces or use abrasive cleansers or cloths, as this could cause damage to some surfaces (such as the heating elements).

Use an alcohol-based commercial glass cleaner and a soft cloth (such as microfiber), to clean any glass or mirrored surfaces.

### Displays

Display screens should only be cleaned using a soft, lint-free cloth designed for cleaning screens and monitors.

Enable Screen Cleaning Mode via the Pilot Panel before cleaning the display screens to prevent the accidental operation of vehicle controls. Select

 >  **Displays > Displays and Accessibility > SCREEN CLEANING MODE.**

-  **WARNING:** Do not use polish or wax cleaners on the display

screens. Polished surfaces are reflective and may make displayed content like vehicle speed and indicator lights harder to read, and also interfere with the driver's view, resulting in an accident.

-  **CAUTION:** Do not use statically-charged materials (such as a cloth that was recently machine-washed and dried) on the displays.

-  **CAUTION:** Do not use cleansers (such as glass cleaner) to clean displays.

### Airbags

-  **WARNING:** Airbag covers should only be cleaned using a slightly dampened cloth or cleaning wipe. Water or any other liquid entering into an airbag or its associated electrical wiring may cause the airbags to inadvertently deploy or not function properly in an accident.

-  **WARNING:** Any damage or cracks on an airbag cover should be referred to a Lucid Service Center for inspection.

### Seats

#### For Cloth Seats:

- Gently vacuum the seats first to remove any loose dust, dirt, or debris (if necessary).
- Use a soft, colorless cloth moistened with warm water and (if necessary) non-detergent soap. Wipe gently in a circular motion. Allow the seats to air dry after cleaning.

#### For Leather and Artificial Leather Seats:

- To clean, use a soft, colorless cloth moistened only with warm water. Do not use polishes, oils, cleaning fluids, solvents, or detergents.



- Avoid vacuuming. Instead, use your moistened cleaning cloth to gently remove any loose particles.
- Application of a leather conditioner is not necessary to maintain the original condition of the seats.

 **WARNING:** Never use steam or upholstery cleaners on the seats, or any cleaning method that would saturate the seat with liquid. This can damage the occupancy weight sensor in the seat, which in turn can affect the operation of the airbag system.

### Seat Belts

 **WARNING:** Never allow any substance to enter a seat belt mechanism, as this can negatively affect its performance in an impact.

Extend the seat belt and clean using a cloth only moistened with water. Do not use any type of detergent or chemical cleaning agent. Allow the belts to air dry while extended, away from direct sunlight if possible.

### Chrome and Metal Surfaces

Do not use abrasive cleansers, rough cloths, or polish, because these materials can damage the finish of these surfaces.

### Plastic Materials

 **WARNING:** Do not use polish or wax cleaner on the upper surfaces of the dashboard. Polished surfaces are reflective and may interfere with the driver's view, resulting in an accident.

Clean heavily-soiled plastic surfaces using warm water and a non-detergent soap, then wipe them with a soft cloth.

### Carpets and Floor Mats

Thoroughly vacuum the carpets and mats before cleaning to remove excess dirt and debris.

Avoid over-wetting the carpets. A diluted upholstery cleaner can be used on heavily soiled areas.

Remove floor mats before cleaning to ensure that they properly dry afterwards. Clean using a microfiber cloth and water or a mild textile cleanser. First spot-test any cleansers to ensure that they will not leave stains. Thoroughly dry the mat before reinstalling it.

#### Floor Mats

 **WARNING:** Loose or improperly-fitted floor mats could interfere with the operation of the foot pedals, which could lead to loss of vehicle control and a collision.

 **Note:** Do not place additional floor mats over the existing ones.

 **Note:** Always install floor mats with the correct side facing up. Do not turn them over.

Using genuine **Lucid** floor mats can extend the life of your vehicle's carpet and make it easier to clean. Mats should be maintained with regular cleaning and replaced if they become worn or damaged.

Floor mats should be periodically inspected to ensure that they are properly installed. Lightly pull on the mat to confirm that it is securely fastened. Fully depress each foot pedal and reinstall the mats if any interference is felt.

---

# Parts and Accessories

---

## Parts, Accessories, and Modifications

 **WARNING:** Lucid does not recommend installing non-approved parts and accessories or performing non-approved vehicle modifications. Doing so can negatively affect your vehicle's performance and the safety of its occupants. The warranty will not cover any damage caused by using or installing non-approved parts or accessories, or performing non-approved modifications.

 **WARNING:** Lucid is not responsible for death, injury, or damage that occurs as the result of using or installing non-approved parts or accessories, or making non-approved modifications.

Genuine **Lucid** parts and accessories are the best choice for your vehicle. Lucid has rigorously tested all of their parts to ensure they meet the highest quality, safety, and performance standards.

Genuine parts and accessories can be purchased and professionally installed at a **Lucid Service Center**, where qualified technicians can offer you the best advice on repairs, accessories, and modifications.

**Lucid** is not responsible for any issues related to using non-**Lucid** parts or accessories on your vehicle because they cannot assess products from other manufacturers or distributors.

 **Note:** Contact **Lucid** if you have a disability that may require modification to the vehicle before modifying it. See Contacting Lucid Motors on page 254.

---

## Body Repairs

Contact a **Lucid Service Center** for referral to an approved body repair shop if your vehicle is damaged due to a collision. This will ensure that repairs are performed by a qualified technician using proper equipment and genuine **Lucid** parts. Poorly performed collision repairs can compromise the performance and safety of the vehicle, and the resale value can diminish.

Some repair shops may suggest using other parts instead of those made by **Lucid**, including salvaged or refurbished parts, or aftermarket parts made by other companies. While these suggestions may cut repair costs, they are not recommended and not covered by the warranty.

- Salvaged parts may maintain the vehicle's designed appearance, but their unknown history means they may have been damaged during the previous vehicle's life or while in storage.
- Refurbished or aftermarket parts have not undergone extensive testing by Lucid to assure their safety or reliability.

Any vehicle failure related to salvaged, refurbished, or aftermarket parts is not covered by the warranty.

# Vehicle Lifting Points

## Lifting the Vehicle

- ⚠ WARNING:** Never raise the vehicle when the charging cable is connected, even if charging is not in progress. Always disconnect the charging cable before raising the vehicle. See Disconnecting the Charging Cable on page 185.
- ⚠ WARNING:** Do not work on an incorrectly supported vehicle. Doing so can cause serious damage, bodily injury, or death.

The lifting points for the vehicle are located at the positions shown below.

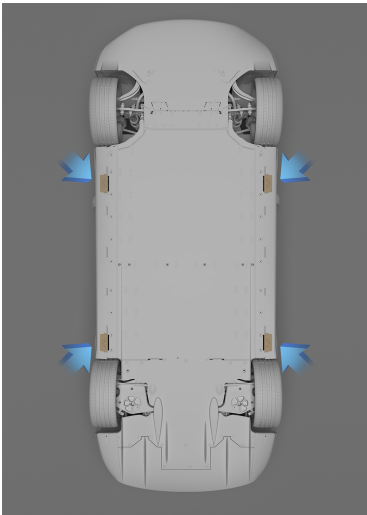

Ensure that any non-Lucid repair facility servicing your vehicle is aware of these lifting points when raising your vehicle on a lift.

- ⚠ CAUTION:** These are the only approved lifting points for your vehicle. Lifting the vehicle at any other points may cause

irreparable damage to the vehicle.

## Steps for Lifting the Vehicle

1. Position the vehicle centrally between the lift posts.
2. Position the lift arm pads under the designated body lifting points at the locations shown.
  - ⚠ CAUTION:** DO NOT position the lift arm pads under the vehicle battery or side rails.
3. Adjust the height and position of the lift arm pads to ensure that they are correctly located.
4. With assistance, raise the lift to the desired height, ensuring the lift arm pads remain in their correct positions.
5. Engage any lift safety locks. Follow the lift manufacturer's instructions.

11

# Tires & Wheels



### 1. Tire Category

**P** indicates that the tire is for passenger vehicles. **HL** indicates that the tire is a high-load rated tire.

 Note: The tire category may not be shown on some tires.

### 2. Tire Width

This three-digit number gives the width in millimeters of the tire from sidewall edge to sidewall edge. Therefore, if a tire is marked **P245/35R21**, then the tire width is 245 mm.

### 3. Aspect Ratio

This two-digit number, also known as the profile, gives the sidewall height as a percentage of the tire width. For example, if the tire width is 245 mm, and the aspect ratio is 35, then the sidewall height will be 85.75 mm.

### 4. Tire Construction

**R** indicates that the tire is of Radial ply construction. Therefore, if a tire is marked **P245/35R21**, then R is the Radial ply construction.

### 5. Wheel Diameter

This two-digit number is the diameter of the wheel rim in inches. So, if a tire is marked **P245/35R21**, then the wheel diameter is 21 inches.

### 6. Load Index

This two- or three-digit number is the tire's load index. It is a measurement of how much weight each tire can support. This number is not always shown.

### 7. Speed Rating

The speed rating, when stated, denotes the maximum speed at which the tire should be used for extended periods. The ratings range from 99 mph (160 kmph) to 186 mph (300 kmph).

These ratings are listed in the following table.

Rating	Speed (mph)	Speed (kmph)
Q	99	160
R	106	170
S	112	180
T	118	190
U	124	200
H	130	210
V	149	240
W	168	270
Y	186	300

### 8. U.S DOT Tire Identification Number (TIN)

Regulations require that the TIN begins with the letters **DOT** and is followed by two numbers or letters that indicate where it was manufactured. The last four numbers represent the week and year the tire was built. For example, the number 1706 means the 17th week of 2006. The other numbers are marketing codes used at the manufacturer's discretion. This information can be used to contact consumers if a tire defect requires a recall.

### 9. Maximum Permissible Inflation Pressure

Maximum permissible inflation pressure means the maximum cold inflation pressure in which a tire may be inflated to. The tire pressure must be at or below this pressure when the tire is cold, but it is okay for the it to exceed this value when it is warmed up.

### 10. Treadwear Grade

This number indicates the tire's wear rate. See Uniform Tire Quality Grading.

### 11. Traction Grade

This letter indicates a tire's ability to stop on wet pavement. See Uniform Tire Quality Grading.

12. Temperature Grade

This letter indicates a tire's heat resistance grading. See Uniform Tire Quality Grading.

13. Tire Composition and Materials

The number of plies in both the tread and sidewall area indicates how many layers of rubber-coated material make up the structure of the tire. Information is also provided on the type of materials used.

14. Maximum Tire Load

This is the maximum load that can be carried by the tire.

15. International Tire Approval Marks

See International Tire Approval Marks.

International Tire Approval Marks

Tire manufacturers must test and certify that all applicable safety and performance standards are met before any tires can be sold in countries. This can include sidewall branding, durability, physical dimensions, high-speed endurance, road noise, and wet traction.

Many tires are globally sold, so tires may be branded with multiple approval codes from various countries.

United States

**DOT** | **United States Department of Transportation (DOT)**

See 8. U.S DOT tire identification number (TIN).

China



**China Compulsory Certification (CCC) Mark**

This is the China Compulsory Certification mark for products being exported to or sold in the People's Republic of China.

Europe



**United Nations Economic Commission of Europe (U.N.E.C.E.)**

The symbol identifying the United Nations Economic Commission for Europe (U.N.E.C.E., sometimes referred to as E.C.E.), is found on a tire's sidewall. The symbol certifies that the tire manufacturer meets all regulations, including the load index and speed symbol appearing in its service description.

The letter **E** or **e** and number code (in a circle or rectangle), identifies the country where the tire was originally registered. The next two digits (the Regulation Series), indicate where the tire was approved (such as **02** for E.C.E. Regulation 30 governing passenger tires). The last digits depict the E.C.E. mark, type-approval numbers.

Tested tires meeting the **pass-by** noise and wet traction limits may have another E.C.E. branding followed by an **-s** and **w** (for sound and wet traction, respectively). One or two E.C.E. symbols may also appear on the tire's sidewall.

Uniform Tire Quality Grading

The following information relates to the tire grading system developed by the National Highway Traffic Safety

Administration (NHTSA), which grades tires by tread wear, traction, and temperature performance.

 *Note:* Tires that have deep tread and winter tires are exempt from these marking requirements.

Quality grades, where applicable, can be found on the tire sidewall between the tread shoulder and maximum section width. For example:

TREADWEAR	TRACTION	TEMPERATURE
180	AA	A

Passenger car tires must also conform to Federal Safety Requirements in addition to the marking requirements.

### Treadwear

The treadwear grade is a comparative rating based on the wear rate of the tire when tested under controlled conditions on a specified government test course.

For example, a tire graded **150** would wear one and a half times as well on a government test course as a tire graded **100**. The relative performance of tires depends on the actual conditions of their use, however, and may significantly depart from the norm due to variations in driving habits, service practices, and differences in both road characteristics and climate.

### Traction

 *Note:* The traction grade assigned to tires is based on straight-ahead braking tests, and does not include acceleration, cornering, hydroplaning, or peak traction characteristics.

The traction grades (from highest to lowest) are: **AA**, **A**, **B**, and **C**. These grades represent a tire's ability to stop on a wet pavement as measured under controlled conditions on specified

government test surfaces of asphalt and concrete. A tire marked **C** may have poor traction performance.

### Temperature

 **WARNING:** The temperature grade for tires is established for those that are properly inflated and not overloaded. Excessive speed, under-inflation, or excessive loading, either separately or in combination, can cause heat build-up and possible tire failure.

The temperature grades are **A** (the highest), **B**, and **C**. These represent the tire's resistance to the generation of heat and its ability to dissipate heat when tested under controlled conditions on a specified indoor laboratory test wheel.

Sustained high temperature can cause the material of the tire to degenerate and reduce tire life, and excessive temperature can lead to sudden tire failure.

The grade **C** corresponds to a level of performance that all passenger car tires must meet under the Federal Motor Safety Standard No. 109.

Grades **B** and **A** represent higher levels of performance on the laboratory test wheel than the minimum required by law.

### Tire and Loading Information Label

Open the left front door to locate the tire information label on the driver's side center pillar.





The label contains the following information:

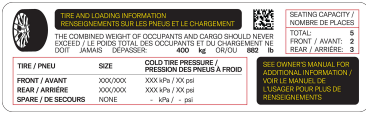

- The Maximum Vehicle Capacity Weight in Kilograms (kg) and Pounds (lb)
- Maximum Number of Occupant Seating Positions in the Vehicle
- The Size of the Tires Originally Fitted to the Vehicle
- The Cold Inflation Pressures for the Original Specification of Front and Rear Tires

The stated tire pressures provide the optimum vehicle ride and handling characteristics for all normal operating conditions.

 Note: Do not change this label, even if you use different tires in the future.

---

# Tire Care and Maintenance

## Inspecting and Maintaining Tires

---

- ⚠️ **WARNING:** The tires should be regularly checked for wear and to make sure that there are no cuts, bulges, or exposure of the ply/cord structure. Do not drive with tires that are worn, damaged, or inflated to the incorrect pressure. Driving under any of these conditions could lead to tire failure and/or loss of control resulting in a collision.

Always consider tire conditions when driving, and regularly inspect the tread and sidewalls for any sign of distortion (bulges), cuts, or wear.

Good driving practice will improve the mileage you obtain from your tires and avoid unnecessary damage.

- Always ensure that the tire pressures are correctly adjusted.
  - Always observe the posted speed limits and advisory speeds.
  - Avoid pulling away quickly or hard acceleration.
  - Avoid making fast turns or sharply braking.
  - Avoid potholes and objects on the road.
  - Do not run over curbs or hit the tire against the curb when parking.
- ⚠️ **CAUTION:** Avoid contaminating tires with vehicle fluids like brake fluid or solvents that can cause damage to the tires or injuries.
  - ⚠️ **CAUTION:** While 21" wheels with low-profile summer tires deliver stellar grip in warm climates with smooth road surfaces, they are more susceptible to damage from potholes and curb strikes,

or reduced grip if driven in snow, ice, or temperatures at or below freezing. Always drive with caution and keep tires properly inflated for optimal performance.

## Tire Wear

- ⚠️ **WARNING:** The tire wear indicators show the minimum tread depth recommended by the tire manufacturer. Tires that have worn to this point will have reduced grip and poor water displacement characteristics.

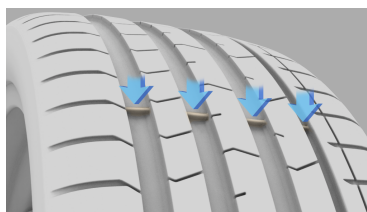

Tires fitted as original equipment have tread wear indicators molded into the tread pattern.

When the tread has been worn down to approximately 2/32 inch (1.6 mm), the indicators become flush with the surface of the tread pattern, producing the effect of a continuous band of rubber across the width of the tire.

A tire must be replaced as soon as an indicator band becomes flush to the tread, indicating the tread has reached the minimum permitted by legislation.

- ✎ **Note:** Your **Lucid Service Center** will evaluate tire wear when servicing your vehicle.

### Wheel Alignment and Tire Balance

Unbalanced wheels (sometimes noticeable as steering wheel vibration), may affect vehicle handling and tire life. Wheels can get out of balance even with regular use. Therefore, you should balance your wheels, as required.

 **Note:** You should check the wheel alignment if tire wear is uneven (on one side of the tire only), or becomes abnormally excessive.

### Wheel and Tire Rotation

 **WARNING:** Your vehicle may be fitted with different size tires on the front and rear wheels. The front and rear wheels may also have different offsets. Do not move wheels between the front and rear axles as this will severely affect vehicle handling.

**Lucid** does not recommend moving the wheels between the front and rear axles, or from side-to-side on the same axle pair.

### Punctured Tires

 **WARNING:** Do not drive the vehicle with a punctured tire. Even if the punctured tire has not deflated, it is unsafe to use as the tire may deflate suddenly at any time.

Your vehicle is fitted with tubeless tires, which may not leak when penetrated (provided the object remains in the tire).

However, immediately reduce your speed if you feel a sudden vibration or ride disturbance while driving, or suspect your tire or vehicle has been damaged. Drive slowly while avoiding heavy braking or sharp steering, and when safe to do so, stop the vehicle.

Inspect the tires for damage. If you notice the tire is under-inflated but has no apparent sidewall damage, try using a

tire repair kit. However, if you are unable to identify the cause of the issue or if the tire is severely damaged, it's best to have the vehicle towed to a tire repair center or **Lucid Service Center** for further inspection.

Frequently checking the tire pressures is important because a puncture will eventually cause the tire to lose pressure. Punctured or damaged tires must be permanently repaired or replaced as soon as possible.

### Age Degradation

Tires degrade over time due to the effects of ultraviolet light, extreme temperatures, high loads, and environmental conditions. It is recommended that tires are replaced every six years, but may require more frequent replacement.

#### Maintaining Tire Pressures

 **WARNING:** Always make sure tires are properly inflated. Under-inflation is the most common cause of tire failures and may result in severe tire cracking, tread separation, or **blowout**, with an unexpected loss of vehicle control and increased risk of injury.

Each tire should be checked monthly and inflated to the pressure recommended on the vehicle placard or tire inflation pressure label. (If the tires on your vehicle differ in size from those listed on the placard or label, you should determine the appropriate inflation pressure for those tires).

Driving on a significantly under-inflated tire will cause the tire to overheat and can lead to tire failure. Under-inflation also reduces battery range and tire tread life, and may affect the vehicle's handling and stopping ability.



Your vehicle has been equipped with a Tire Pressure Monitoring System (TPMS) as an added safety feature. A low-tire

pressure indicator will illuminate when one or more of your tires is significantly under-inflated. You should stop and check your tires as soon as possible when the low tire pressure indicator illuminates, and inflate them to the proper pressure. See Tire Pressure Monitoring System (TPMS) on page 221.

- ⚠ **WARNING:** TPMS is not a substitute for proper tire maintenance. As the driver, it is your responsibility to maintain correct tire pressure, even if under-inflation has not reached the level to trigger illumination of the TPMS low tire pressure indicator.

### Checking Tire Pressure

- ⚠ **WARNING:** Each tire should be checked monthly when cold and inflated to the pressure recommended on the vehicle placard or tire inflation pressure label.
- ⚠ **CAUTION:** If the vehicle has been parked in strong sunlight or used in high ambient temperatures, do not reduce the tire pressures. Move the vehicle into the shade and allow the tires to cool before checking, as driving with over or under inflated tires can lead to uneven wear of the tires, and affect vehicle handling.
- ⚠ **WARNING:** Do not exceed the maximum pressure stated on the sidewall of the tire. Over-inflation could cause the tire to fail suddenly.
- 📝 **Note:** The COLD Tire pressure is defined as the air pressure in a tire that has been standing in excess of three hours, or driven for less than one mile.

Select  >  **Vehicle > Tire Pressure** to view the current tire pressures on the Pilot Panel.

- 📝 **Note:** Tire pressure is shown once the vehicle is driven over 13 mph (21 kmph).

If it is necessary to check the tires when they are warm, you should expect the pressures to have increased. Do not reduce the pressure of warm tires in an attempt to match the recommended cold tire pressures.

Select the **RECOMMENDED** tab to view the recommended COLD tire pressures for your vehicle. Always inflate your tires to the pressures recommended by **Lucid**, even if it is different from the maximum inflation pressure information found on the tire itself.

### Adjusting Tire Pressure

To check and adjust tire pressure:

1. Remove the cap from the valve, then firmly press the tire gauge onto the valve and measure the pressure.
2. If required, add air to reach the required pressure.
3. Check the pressure by removing the tire gauge and then re-attaching it. Failure to remove and re-attach the gauge to the valve could cause the gauge to show an incorrect reading.
4. If the tire pressure is too high, remove the gauge and release air from the tire by pressing on the metal stem in the center of the valve. Refit the gauge to the valve and check the pressure.
5. Repeat the process of adding or removing air as required until the correct tire pressure is reached.
6. Refit the valve cap.

### Tire Valves

Keep the valve caps firmly screwed down firmly to prevent water or dirt from

entering the valve. Check the valves for leaks when checking the tire pressures.

### Flat Spots

The tires may form flat spots if the vehicle is stationary for a long period during high, ambient temperatures. When the vehicle is driven, these flat spots will cause a vibration that will steadily disappear as the tires warm up and regain their original shape.

### Tire Pressures During Long-Term Storage

Inflate tires to the maximum pressure as indicated on the tire wall to minimize flat spots during storage.

- ⚠ **WARNING:** The tire pressures must be reduced to the correct pressure before the vehicle is driven.

### Replacing Tires and Wheels

- ⚠ **WARNING:** For your safety, it is recommended that only wheels and tires that match the original specification are used on the vehicle. Specifications for approved winter tires are available by contacting your **Lucid Service Center**.
- ⚠ **WARNING:** Operation of the Tire Pressure Monitoring System (TPMS) may be affected if the tires are replaced with a different specification from the originals.

Wheel rims and tires are matched to suit the handling characteristics of the vehicle. Always check that replacement tires comply with the original specification. If tires other than those specified are used, ensure that the load and speed ratings (shown on the tire side wall), equal or exceed those of the original specification.

Ideally, tires should be replaced as sets of four. If this is not possible, replace the tires in pairs (front and rear). The wheels

should be balanced and the alignment checked when replacing tires.

### Asymmetric Tires

- ⚠ **WARNING:** Vehicle traction and handling will be seriously impaired if the tires are incorrectly installed on the wheels.

Your vehicle is equipped with asymmetric tires that have different tread patterns on the outer and inner edge of the tire. On the outside edge, the tread pattern exhibits large tread blocks that are designed to provide dry traction and handling thanks to a larger contact area with the road.

On the inside edge, the tread block is smaller to provide better wet grip. An increased number of grooves helps disperse water on wet roads and reduce the risk of aquaplaning. This means that the tire is built to provide great performance in both wet and dry conditions.

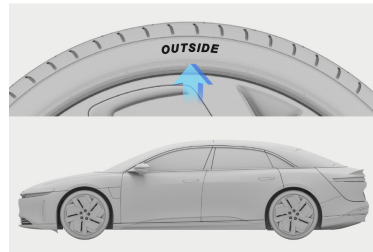

Asymmetric tires must be mounted on the wheel with the correct sidewall facing outwards from the vehicle. The sidewall of the tire is marked with the word **OUTSIDE**.

Always make sure the tires are correctly oriented when new tires are installed.

---

## Run-Flat Tires

-  **CAUTION:** The installation of run-flat tires is not recommended by Lucid as they may cause issues with the sensors for the Tire Pressure Monitoring System (TPMS).

### Seasonal Tire Types

---

#### Summer Tires

Your vehicle may be originally equipped with high-performance summer tires. Summer tires are designed for maximum dry and wet road performance but are not designed to perform well in winter conditions.



**Lucid** recommends using winter tires if driving in cold temperatures or on roads where snow or ice may be present.

-  **WARNING:** Summer tires are not designed to provide adequate traction during cold temperatures, on snow, or ice. Selecting and installing the appropriate tires for winter conditions is important to ensure the safety and optimum performance of your vehicle.

#### All-Season Tires

Your vehicle may be originally equipped with all-season tires. These tires are designed to provide adequate traction in most conditions year-round but may not provide the same level of traction as winter tires in snowy or icy conditions. All-season tires can be identified by **ALL SEASON** and/or **M+S** (mud and snow) on the tire sidewall.

#### Winter Tires

-  **WARNING:** Always follow the tire manufacturer's instructions. Pay attention to your tires' maximum permitted speed and the recommended tire pressures.
-  **WARNING:** The traction provided by winter tires on dry roads

may be less than your original specification tires.

Use winter tires to increase traction when driving in sustained temperatures below 50°F (10°C) or in snowy or icy conditions.

For winter tires, always install a complete set of four tires at the same time. All winter tires should be the same diameter, brand, construction, and tread pattern on all four wheels.

For recommendations on winter tires, contact your **Lucid Service Center**.

### Driving in Low Temperatures

---

Tire performance is reduced in low ambient temperatures, resulting in reduced grip and increased susceptibility to damage from impacts. Performance tires can temporarily harden when cold, causing you to hear rotational noise for the first few miles (kilometers) until the tires warm up.

-  **WARNING:** **Lucid** does not recommend using the Summer tires when tire temperatures drop below 45°F (7°C) or on snow and ice, as the grip level of the tire degrades when the compound nears freezing.

-  **WARNING:** Do not use, roll, or drop the Summer tires with temperatures below 20°F (-7°C). Allow them to warm up in a heated space to at least 45°F (7°C) before installing, or moving a vehicle on which they are installed, in such conditions.

-  **WARNING:** Do not apply heat or blow heated air directly on the tires.

-  **WARNING:** Never use a tire with freeze cracks, breaks, or damage to the sidewall or tread.



### Tire Chains

-  **CAUTION:** The use of tire chains is not approved or recommended by **Lucid**. Using tire chains may damage your vehicle's suspension, body, wheels, and/or brake lines. Damage caused by using tire chains will not be covered by the New Vehicle Limited Warranty.

### Snow Socks

In conditions where tire traction is challenging, snow socks may be fitted for improvements in grip. Depending on the snow sock, permitted use cases may vary. Refer to the snow sock owner's manual for specific details on your product.

Snow socks are the recommended snow traction device and recommended installation is on rear axle tires.

-  **Note:** Winter tires usually offer more traction than snow socks.
-  **Note:** Although approved by **Lucid**, the use of snow socks may still be prohibited. Check **applicable** local laws before installing snow socks.

For recommendations on snow socks, contact your **Lucid Service Center**.

### Maintaining Wheel Trims ---

Several designs of Lucid Air wheels feature inserts that reduce aerodynamic drag at typical vehicle speeds. These inserts are recommended to be removed before prolonged spirited driving to increase brake cooling and must be removed before driving at speeds above 120mph / 193kph. Failure to do so may result in the inserts coming loose and ejecting from the wheel, and potentially coming in contact with nearby people or property.

-  **WARNING:** High-speed driving is inherently dangerous in any vehicle and should only be undertaken where legally permitted and by appropriately trained and experienced drivers. Always obey all traffic laws and never drive at a speed greater than is reasonable or prudent having due regard for conditions such as weather, visibility, road surface, the presence of other vehicles, objects, or pedestrians, and in no event at a speed that endangers the safety of persons or property. Vehicle damage sustained during track or competition use is not covered by Lucid's New Vehicle Limited Warranty.

Tire pressure for **Air Sapphire** road use is 42psi (290 kPa) for all speeds and conditions.

 **Note:** Track or competition use of the vehicle is not covered under the **Lucid New Vehicle Limited Warranty**.



### Tire Inflation Pressure For Track Use

#### Racetrack

For driving on a race track, tires should be inflated so that when hot (i.e. driven hard on track) the inflation pressure is 40-42psi. To achieve this, it is recommended to begin with a cold inflation pressure of 30-35psi, then monitor tire pressure throughout your track session using either the onboard Tire Pressure Monitoring System, or an external tire pressure gauge.

#### Dragstrip

When preparing your **Air Sapphire** for a dragstrip event, begin with a cold inflation pressure of **36psi**. The tire temperature is critical to ensure optimal straight line performance. To ensure sufficient tire temperature, perform a burnout using launch mode with stability control set to **OFF**.

-  **WARNING:** When driving on cold tires at 30-35psi, be aware that until temperatures and pressures rise the vehicle will exhibit altered handling characteristics and extra care and attention should be used. When driving on tires at 30-35psi, no more than two people should be in the vehicle, and no cargo should be carried.
  
-  **WARNING:** After driving on track, ensure that tires cool and are set to the standard inflation pressure before driving on public road.



# Tire Pressure Monitoring System

## Tire Pressure Monitoring System (TPMS)

- ⚠ **WARNING:** The TPMS is not a substitute for manually checking tire pressures. The TPMS only provides a tire pressure warning and does not re-inflate the tires.
- ⚠ **WARNING:** The TPMS cannot detect damage to a tire. Regularly check the condition of your tires.
- ⚠ **WARNING:** Using liquid or aerosol tire sealants may cause a malfunction of tire pressure sensors.

The TPMS monitors the pressure of the tires using sensors located in each wheel. In-vehicle sensors receive TPMS data using Radio Frequency (RF) signals.

- 📎 *Note:* Installing accessories that are not approved by **Lucid** may interfere with the TPMS system.



Tire pressure warnings are displayed on the Glass Cockpit via an amber warning indicator. A warning chime will sound and a warning message will display to alert you to a problem.

The tire pressure warning indicator will illuminate if a tire is under-inflated.

Stop and check your tires as soon as possible if the tire pressure warning indicator illuminates, and inflate the tires to the correct pressure. The cause must be determined and rectified if the tire pressure warning frequently occurs.

### Tire Pressure Information Display

The Glass Cockpit will provide an overview of the tire pressures on the vehicle if low tire pressure is detected. The wheel with the low pressure will be displayed in amber.

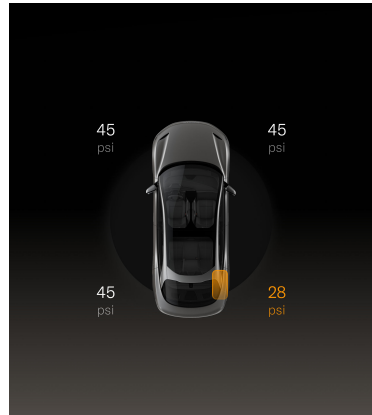

### TPMS Malfunction

Your vehicle is equipped with a TPMS malfunction indicator to indicate when the system is not properly operating.

The TPMS malfunction indicator is combined with the low tire pressure indicator. The indicator will flash for approximately one minute when the system detects a malfunction, and will remain continuously illuminated. This sequence will continue upon subsequent vehicle start-ups as long as the malfunction exists.

The system may not be able to detect or signal low tire pressure as intended when the malfunction indicator is illuminated. TPMS malfunctions may occur for a variety of reasons, including the installation of replacement or alternate tires or wheels on the vehicle that prevents the TPMS from functioning properly. Always check the TPMS malfunction indicator after replacing one or more tires or wheels on your vehicle to ensure that the replacement or alternate tires and wheels allow the TPMS to properly function.

---

 Note: It is possible that the TPMS has been damaged if a tire has been repaired using tire sealant and a low tire pressure is detected. Contact a **Lucid Service Center** to have the issue rectified as soon as possible.

### **Tire Pressure Correction**

The tire pressure indicator light does not automatically turn off when the tire pressure is adjusted for all four tires.

Once you have inflated your tires to their correct pressures, drive your vehicle at a speed of at least 18 mph (30 kmph) to activate the Tire Pressure Monitoring System (TPMS) and disable the low tire pressure indicator light.

### **Tire Changing**

Always have your tires serviced or changed by a qualified technician.

Care must be taken to avoid contact between the bead of the tire and the sensor during removal and refitting of the tire or the sensor may become damaged and/or inoperable.

### **Replacing a Tire Pressure Sensor**

If you are receiving frequent low tire pressure warnings despite the tire pressures being correct, please contact the **Lucid Service Center** to determine if a tire pressure sensor replacement is necessary.

 Note: A tire pressure sensor may not work if a non-Lucid Service Center has replaced, until it has been programmed to the vehicle by **Lucid**.

# Vehicle Loading

## Loading the Vehicle

- WARNING:** Overloading the vehicle has an adverse effect on braking and handling characteristics, which can compromise your safety or damage the vehicle.

It is important to understand the maximum weight rating for your vehicle and how much weight your vehicle can safely carry.

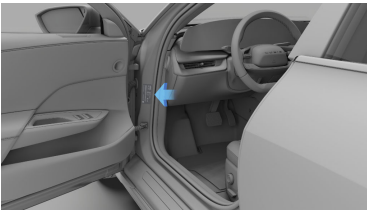

See the vehicle certification label for your vehicle's Gross Vehicle Weight Rating (GVWR). It is located on the driver side front door jamb by the front wheel.

- Note:** Gross Vehicle Weight Rating (GVWR) is also known as the total allowable mass of the vehicle. This weight includes the vehicle's curb weight, all occupants, cargo, and any additional equipment installed on the vehicle since it was manufactured.

- CAUTION:** To prevent severe damage to the vehicle, never load the vehicle to be heavier than the GVWR.

## Carrying Items

- WARNING:** The frunk and trunk are the preferred places to carry objects. In an accident, during hard braking, or sudden

maneuvers, loose items carried in the vehicle's cabin area can be thrown around and cause injury to occupants.

- CAUTION:** Heavy loads should be evenly distributed throughout the vehicle so as not to exceed the Gross Axle Weight Ratings (GAWR) shown on the vehicle certification label. Refer to the tire information and loading label in the next section to determine the recommended maximum allowable weight that can be added to the vehicle to safely operate it and not damage the vehicle.

## Towing a Trailer

- WARNING:** Do not tow a trailer with your vehicle. The vehicle has not been designed to have a trailer hitch fitted to it. The installation of a trailer hitch may cause serious damage to the vehicle, which could result in an accident or serious injury.

### Steps for Determining Correct Load Limit

1. Locate the statement **The combined weight of occupants and cargo should never exceed xx kg or xx lb** on your vehicle's placard, (the tire information and loading label).
2. Determine the combined weight of the driver and passengers that will be riding in your vehicle.
3. Subtract the combined weight of the driver and passengers from the never exceed weight identified in step 1.
4. The resulting figure equals the available amount of cargo and luggage load capacity. For example, if the total amount equals

---

950 lb (431 kg) and there will be five 150 lb (68 kg) passengers in the vehicle, the amount of available cargo and luggage capacity is 200 lb (91 kg)  $(950 - 750 (5 \times 150)) = 200$  lb).

5. Determine the combined weight of luggage and cargo being loaded on the vehicle. That weight may not safely exceed the available cargo and luggage load capacity calculated in Step 4.

### Example Load Limit Calculations

The number and weight of passengers will affect the weight of available cargo and luggage load capacity.

The following are typical examples of calculated load limits:

Description	Total
<b>Vehicle Capacity Weight</b>	<b>950 lb (431 kg)</b>
<b>Subtract Occupant Weight (2 x 150 lb)</b>	<b>300 lb (136 kg)</b>
<b>Available Cargo or Luggage Weight</b>	<b>650 lb (295 kg)</b>

Description	Total
<b>Vehicle Capacity Weight</b>	<b>950 lb (431 kg)</b>
<b>Subtract Occupant Weight (4 x 150 lb)</b>	<b>600 lb (272 kg)</b>
<b>Available Cargo or Luggage Weight</b>	<b>350 lb (159 kg)</b>

 **Note:** Calculations for the available cargo and luggage capacity assume that the passengers weigh 150 lb (68 kg). The available cargo and luggage load capacity will decrease if the passengers weigh more than this.

12

# Technical Data

# Vehicle Dimensions and Weights

## Exterior Dimensions

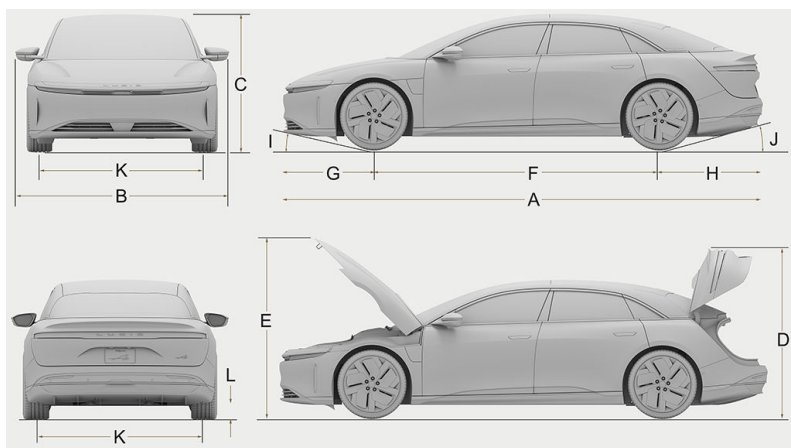

Identifier	Description	Dimensions
A	Overall Length	197 in (5004 mm)
B	Overall Width - Mirrors Extended	86 in (2196 mm)
B	Overall Width - Mirrors Folded	79in (1990mm)
C	Overall Height	56 in ( 1408mm)
D	Overall Height - Deck Lid Open	69 in (1747 mm)
E	Overall Height - Hood Open	73 in (1842 mm)
F	Wheelbase	117 in (2960 mm)
G	Front Overhang	38 in (970 mm)
H	Rear Overhang	42 in (1075 mm)
I	Approach Angle	10°
J	Departure Angle	13°
K	Track - Front	67 in (1698 mm)
	Track - Rear	66 in (1674 mm)
L	Minimum Ground Clearance between axles	4.9 in (124 mm)
L	Minimum Ground Clearance under front axle	5.0 in (126 mm)

---

Identifier	Description	Dimensions
L	Minimum Ground Clearance under rear axle	5.9 in (150 mm)

---

**Curb Weight**

**Sapphire** 5336 lbs (2420 kg)

\*Curb Weight = The Weight of Vehicle with Correct Fluid Levels, No Occupants, and No Cargo

**Other**

---

Gross Vehicle Weight Rating (GVWR) See **Vehicle Certification Label** on page 12

---

Gross Axle Weight Rating (GAWR) - Front See **Vehicle Certification Label** on page 12

---

Gross Axle Weight Rating (GAWR) - Rear See **Vehicle Certification Label** on page 12

---

GVWR Weight Distribution - Front : Rear (%) 49.3 : 50.7

---

Trailer Towing Not permissible



---

# Vehicle Sub-Systems

## Steering

---

Type	Rack and Pinion with Electronic Power Steering and Speed Sensitive Assist
Number of Turns Lock to Lock	2.3 Turns
Turning Circle (Curb to Curb)	39 ft (11.9 m)

---

 Brakes
 

---

Type	4-Wheel Anti-Lock Braking System (ABS) with Electronic Brake Force Distribution, Electronic Stability Control and Electronic Accelerator Pedal-Actuated Regenerative Braking System
Calipers	Front: Ten-Piston Fixed Rear: Four-Piston Fixed
Rotors	Ventilated Front and Rear Rotors Front Diameter: 16.5 in (420 mm) Rear Diameter: 15.35 in (390 mm)
Front Rotor Thickness	New: 1.6 in (40 mm) Service Limit: 1.55 in (39 mm)
Rear Rotor Thickness	New: 1.18 in (30 mm) Service Limit: 1.10 in (28 mm)
Front Brake Pad Thickness	New: 0.43 in (11 mm) Service Limit: 0.08 in (2 mm)
Rear Brake Pad Thickness	New: 0.35 in (9 mm) Service Limit: 0.08 in (2 mm)
Parking Brake	Integrated Electronically Actuated Motor-On-Caliper

Wheel and Tire Specifications

**Lug nut Specifications**

 Note: For details on where to lift your vehicle, see Lifting the Vehicle on page 207.

**Lug nut torque** **150 Nm**

**Lug nut socket size** **21 mm**

**Lucid Air Sapphire**

Wheel Type	Position	Size
20" - Aero Sapphire	Front	20x9.5"
21" - Aero Sapphire	Rear	21x10.5"

Tire Type	Position	Size	Load Index / Speed Rating
20" - Michelin Pilot Sport 4S - Summer	Front	265/35ZR20	XL/(99Y)
21" - Michelin Pilot Sport 4S - Summer	Rear	295/30ZR21	XL/(102Y)

---

Front Suspension

---

Type	Independent 5-Link with Stabilizer Bar		
Alignment	CAMBER	CASTER (for Inspection, not Adjustable)	TOE
	Optimum	-1.70°	6.5°
Tolerance	+0.25°	+0.5°	+0.05°
	-0.25°	-0.5°	-0.05°

 Note: The specifications listed are for a vehicle at curb weight.

Rear Suspension

Type	Independent Integral Link with Stabilizer Bar		
Alignment		CAMBER (for Inspection, not Adjustable)	TOE
	Optimum	-1.77°	0.110°
	Tolerance	+0.5°	+0.05°
		-0.5°	-0.05°

 Note: The specifications listed are for a vehicle at curb weight.

---

#### Motors

---

#### Air Sapphire

- Front: Permanent magnet AC motor.
- Rear: Twin permanent magnet AC motors with torque vectoring.

#### Transmission

---

#### Drive Ratio

**Air Sapphire** Front: 7.06:1 Single Speed

Rear: 6.78:1 Single Speed

#### 12V Batteries

---

Type	Deep Cycle
Quantity	2
Rating	18 Ah
Voltage and Polarity	12V Negative (-) Ground

#### High-Voltage Battery

---

Type	Lithium Ion (Li-Ion)
Cooling	Liquid-Cooled

13

# Roadside Assistance & Emergency Information

---

# Roadside Assistance

## Contacting Roadside Assistance

---

**Lucid** is committed to providing excellent service. Our Roadside Assistance Program is available 24 hours a day, 365 days a year.

For assistance, call **+1 888-995-8243 (888-99-LUCID)**.

Provide the representative with the following information:

- Vehicle Identification Number (VIN)
- Vehicle Description
- License Plate Number
- Problem with the Vehicle
- Your Location

Lucid ensures appropriate transportation of its vehicles under the **Lucid Roadside Assistance Program**. However, if you do not secure transportation/towing through our Customer Care Department, it is your responsibility to provide the vehicle transporter with instructions on how to transport the vehicle. See [Transporting the Vehicle](#).

### Services Covered

The following are covered at no charge for four years or 50,000 miles, whichever comes first:

- Emergency Towing/Transport Service for Warranty Repairs to the Nearest Authorized Lucid Service Center
- Roadside Service
- Flat Tire
- 12v Battery

For one year from the date of original sale of the vehicle, Lucid will also provide towing and transport to an authorized Collision Repair facility in the event of an accident.



# Instructions for Transporters

## Vehicle Towing and Recovery Methods

 **Note:** Directly attaching chains or hooks to vehicle components is not approved by Lucid and may result in vehicle damage. Lucid will not warrant nor be held liable for damage caused by directly attaching hooks, chains, or straps to vehicle components.

Lucid prefers the use of the Rollback truck (Flatbed) that includes the Self-Loading Recovery Dolly, Tow Eye or Tow Strap.

### 1. High-Speed Dolly

High-speed dolly systems support the vehicle's rear wheels, while a tow vehicle supports the front wheels. **This is Lucid's recommended recovery option for short distances.**

Always follow recovery equipment's manufacturer instructions for use.



### 2. Self-Loading Recovery Dolly

Self-loading dolly systems allow winching a vehicle onto a flatbed carrier or rollback tow truck. They incorporate an attachment point for the winch cable directly to the dollies. Use this method when wheels are locked (e.g., due to power loss). Self-loading dollies support all wheels during winching to reduce the risk of vehicle damage.

Always follow the recovery equipment's manufacturer instructions for use.

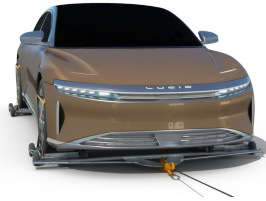

Make sure to secure the vehicle onto the bed as per the dolly's manufacturer instructions, with the vehicle remaining on the dollies.

See detailed instructions under Securing Vehicle for Transportation on page 243.

### 4. Tow Eye / Tow Strap

The tow eye or strap can only be used at the front of the vehicle, but has load limitations (13.9kN/ 1426kg/ 3100lbs) with vertical and horizontal angular limitations for the operation of the winch cable relative to the location of the tow eye or strap attachment.

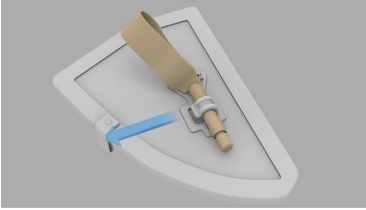

Carefully review the instructions under **Towing Device Method on page 240** before use and consider these limits before using the tow eye.

#### Transporting the Vehicle

- ⚠ **WARNING:** If the high-voltage battery pack has been damaged, punctured, or compromised, further flexing or structural twisting of the vehicle could lead to thermal runaway, fire, or re-ignition of the high-voltage battery pack. If you know or suspect that the high-voltage battery pack has been severely damaged, do not move the vehicle unless it is necessary for safety reasons to do so, and contact Lucid Customer Care.

**NOTE:** All four wheels must remain off the ground when towing or transporting the vehicle.

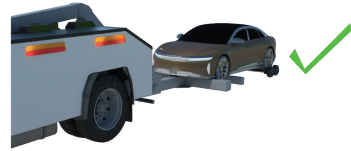

**DO NOT TOW THE VEHICLE WITH ANY OF ITS WHEELS ON THE GROUND.**

- ⚠ **WARNING:** Towing the vehicle with the wheels on the ground may cause serious damage to the vehicle.

#### Preparing Vehicle for Transportation

- ⚠ **WARNING:** The high-voltage battery pack can ignite or re-ignite after an incident if the structure of the battery has been damaged as a result of an accident. Store the vehicle a minimum of 50 ft / 15 m from other vehicles, structures, and flammable materials for a minimum of 24 hours, and monitor vehicle temperatures with a thermal imaging camera.



**⚠ WARNING:** The vehicle is equipped with high-voltage components that may be compromised as a result of a collision. It is important to assume these components are energized. Always follow high-voltage safety precautions until emergency response professionals have evaluated the vehicle and can confirm that all high-voltage systems have been disabled. Failure to do so may result in serious injury or death.

**⚠ WARNING:** Lack of engine sounds does not mean the vehicle is off. Silent movement or instant restart capabilities exist until the vehicle is fully shut down. Wear appropriate PPE.

**✎ Note:** The vehicle automatically engages the electronic parking brake when the driver's door opens. Use a combination of jack/dollies or tire skates under rear wheels to prevent vehicle damage if the vehicle electrical systems are not functioning and/or the electronic parking brake cannot be disengaged.

### Pushing the Vehicle

The **Lucid Air** can be pushed to clear the roadway in situations where there is a minimal risk of fire or high-voltage exposure, (for example, the vehicle does not accelerate after stopping at an intersection), and 12V power is present. Shift the **Lucid Air** into Neutral (N) if a driver is present and push the vehicle. The **Lucid Air** may shift into Park (P) if a driver is not present when it detects the driver leaving the vehicle, even if it has previously been shifted into N.

**Lucid** recommends using only the A and B pillars when pushing by hand with the windows in the down position.

**✎ Note:** Body damage will likely occur if the pushing recommendation is not followed. **Lucid** will not warranty nor be held liable for issues that may

result from failure to follow these instructions.

**✎ Note:** **Lucid Air** must detect a key in the vehicle and low-voltage power is required to shift the vehicle into Neutral (N).

**✎ Note:** The touchscreen is unresponsive if the **Lucid Air** has no low-voltage power. Check the wheels. Then, use an external, low-voltage power source to supply power and shift into Neutral (N). **The external power source must be disconnected before moving the vehicle once in N.** The vehicle will be free rolling when using this method, until the external power is reconnected and the vehicle is shifted into the Park (P) position.

See detailed instructions under Connecting External 12V Power on page 243.

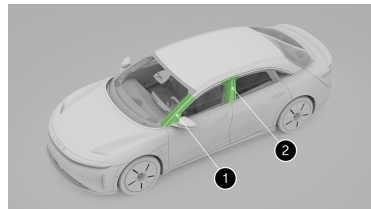

1. A Pillar
2. B Pillar

### Immobilize the Vehicle

1. Immobilize the vehicle before starting any recovery operation by installing wheel chocks to prevent roll-away.

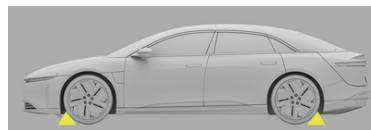

2. Apply the Electronic Parking Brake (EPB) by pressing the button on the end of the right-hand mode selector stalk.

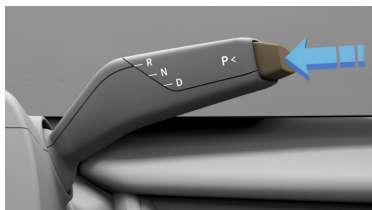

3. Ensure that the vehicle is immobilized, (using the previous steps), if lifting is required.
4. Use the provided jack points indicated in the image when lifting the vehicle. Do not lift the vehicle under the battery pack location, illustrated by the orange shaded area in the adjacent image.

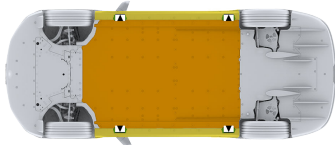

**▲ Approved Lifting Points**

**■ High-Voltage Battery Pack**

Towing Device Method

- ▲ WARNING:** Use the towing device only for loading and unloading the vehicle to/from tow trucks or transports. Under no circumstances should the vehicle be towed by another vehicle along the road using the vehicle towing device. Doing so can lead to sudden towing device detachment, which may

lead to vehicle damage, injury, or death.

- ▲ WARNING:** The towing device should not be used in situations where the winch cable load will exceed 13.9kN/ 1426kg/ 3100lbs. Exceeding these limits may cause failure of the towing device, which may lead to damage, serious injury, or death.

The vehicle includes a towing device in the trunk under the right-hand side access panel.



Opening the Trunk

- ✎ Note:** It is necessary to connect an external 12-volt power source to access the tow eye before proceeding if the vehicle's low-voltage power is disabled. See the instructions under Connecting External 12V Power on page 243 .

**Option 1**

Touch the 'Openings' icon at the top from the large center touchscreen. Then touch the Trunk Open icon on the lower right of the touchscreen.



**Option 2**

1. Push the trunk release button located above the rear license plate area.



2. Open the trunk and remove the towing device from under the right-side trunk floor panel.

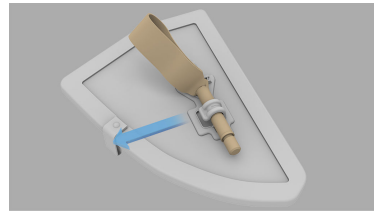
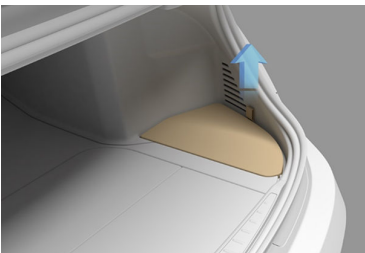

3. Remove the power source if an external power source was used to access the trunk, and secure the wiring before moving the vehicle to avoid damage.

Installing the Towing Device

**⚠ WARNING:** Improper towing device installation could result in the towing device detaching suddenly during vehicle winching. This may cause significant vehicle damage and could result in injury or death to anyone nearby.

1. The attachment point is located on the front of the vehicle towards the left side. Release the rubber cover from the attachment point between the front grille.

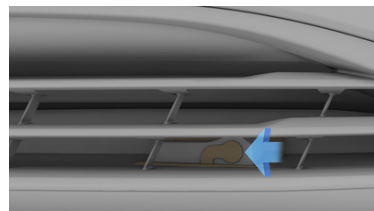

2. Position the towing device through the bumper and rotate it clockwise into the attachment point on the body until it is fully seated. The towing device shaft should be parallel to the ground.

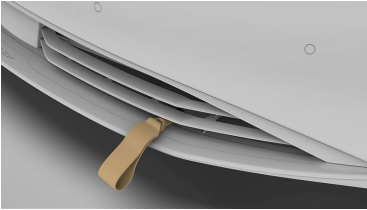

3. Attach the winch cable to the tow eye. **The pull angles must not exceed 5 degrees from center either up or down and 25 degrees from center either left or right.**

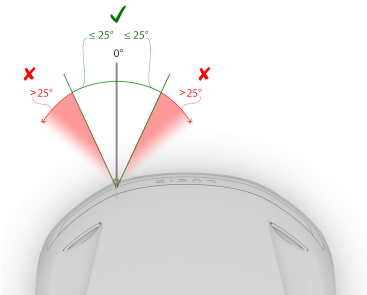
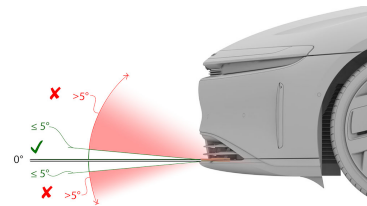

**⚠ WARNING:** Do not use the vehicle towing device if the pull angle is greater than 5 degrees vertically from shaft-center either up or down. Exceeding these limits may cause tow eye detachment that could result in injury or death.

**⚠ WARNING:** Do not use the vehicle towing device if the

pull angle is greater than 25 degrees horizontally from shaft-center to either side. Exceeding these limits may cause towing device detachment that could result in injury or death.

4. Place the vehicle in Neutral (N) by pressing and holding halfway down on the mode selector stalk while holding the brake pedal. The vehicle must always be placed in Neutral with all brakes disengaged. Wheels must be able to move freely. Do not winch the vehicle while the parking brake or the brake pedal is applied. Never drag the vehicle along the ground, as this may exceed the maximum towing line force. Use a combination of jack dollies or tire skate if the wheels cannot roll freely.
5. Winch the vehicle slowly onto the trailer or transporter. Avoid shock loading. Ensure the winch cable line load does not exceed 13.9kN/ 1426kg/ 3100lbs.

**⚠ WARNING:** Do not allow anyone to stand or walk behind the vehicle during winching operations. In the event of winch/cable or towing device failure, vehicle may roll backwards unexpectedly. This could cause serious injury or death.

6. Immobilize the vehicle once it is loaded by placing it in Park (P).
7. Store the towing device back in the trunk after using it and install the rubber cover on the attachment point. Proceed with securing the vehicle for transport.

## Securing Vehicle for Transportation

- ⚠ **WARNING:** Attaching straps to the chassis, suspension, or other parts of the body may damage the vehicle.

Use chocks and tie-down straps to secure the wheels when the vehicle is in position on the transporter or trailer.

To avoid damage:

- Ensure that the metal parts on the tie-down straps do not come in contact with the vehicle's painted surfaces or the face of any wheels.
- Do not place straps over or through the vehicle's body panels.

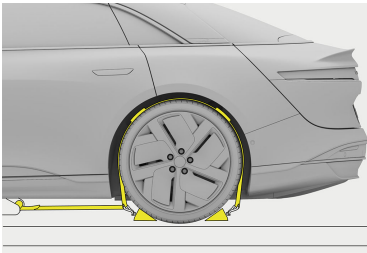

to the external power source manufacturer's instructions for use.

- ✎ **Note:** Use a 12-volt jumper pack or equivalent. Do not use **Boost** or **Starting** modes as these may exceed the electrical specifications of the vehicle jumper connection (12-14.4 Volts 50 Amps Max).

- ✎ **Note:** Lucid will not warranty nor be held liable for issues that may result from failure to follow these instructions.

1. Jumper leads are located under the wheel well liner just aft of the right rear wheel. Carefully remove the 2 lower pop clips using a tool such as a flathead screwdriver. Pull the wheel liner out far enough to expose the jumper leads.

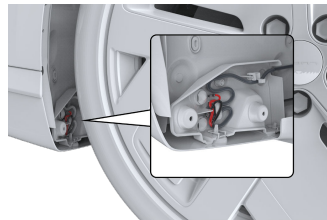

## Connecting External 12V Power

- ⚠ **WARNING:** Do not connect a battery charger to the jumper wires. This will exceed the maximum allowable electrical ratings of 12-14.4 Volts 50 Amps. Damage to the ECUs will result. Do not use 12-volt jumper leads for charging the 12-volt batteries. They are only intended for opening a car when the low-voltage system is depleted.

- ⚠ **WARNING:** While external power source is connected, ensure positive (+ red) and negative (- black) leads do not come in contact with each other. This could cause sparks or damage the external power source. Refer

2. To extend the leads from the wheel well area, carefully remove the jumper lead retainer clips (indicated by yellow arrows in the image), using a tool such as a flathead screwdriver. Route the black lead back through the retainer loop (indicated by the blue arrow in the image). Once the leads are free, they can be extended beyond the wheel to connect to the external power source. The red lead should be connected before the black lead.

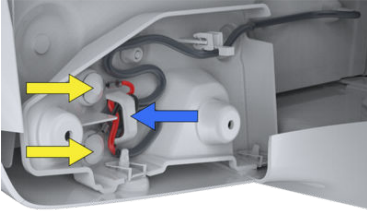

3. Remove external power source and re-secure wires before moving the vehicle. Failure to disconnect an external 12V system prior to continuing tow activities can lead to serious vehicle damage.

**Additional Information:**

Towing providers with questions should call 888-99-LUCID (888-995-8243).



# Disabling the Power System

## Safety Precautions

- ⚠ **WARNING:** In the event of fire, immediately contact your local fire emergency responders.
- ⚠ **WARNING:** ALWAYS ASSUME THAT HIGH-VOLTAGE COMPONENTS ARE ENERGIZED. Cutting, crushing, or touching high-voltage components can result in serious injury or death.
- ⚠ **WARNING:** High-voltage cables and components may remain energized for up to 2 minutes after disabling.
- ⚠ **WARNING:** High-voltage batteries can self-ignite even after extinguishing the initial fire.
- ⚠ **WARNING:** The airbags and other supplemental restraint systems may remain powered for up to 2 minutes after disabling.
- ⚠ **WARNING:** In the event of a fire involving a charging station, treat it as an energized electrical fire until power to the charger is confirmed to be de-energized.
- ⚠ **WARNING:** Lack of engine sounds does not mean the vehicle is off, silent movement or instant restart capabilities exist until the vehicle is fully shut down. Wear appropriate PPE.

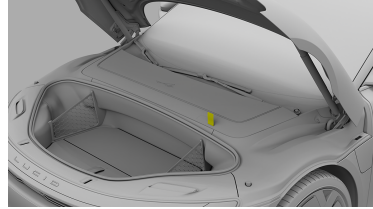

You can determine the location of the cut loop by the yellow label wrapped around it. This label should be visible, even with the maintenance access panel in place.

The primary method to isolate the high voltage system is to unplug the First Responder Loop connector and remove the loop. The emergency alternate method to isolate the high voltage system is to complete 2 cuts (one on each side of the First Responder Loop Label), and remove that section completely.

 **Note:** The cut loop is a low-voltage (12V) cable.

## First Responder Cut Loop

The First Responder cut loop is located under the hood on the Left Hand side near the suspension strut tower and may be concealed by the cowl cover. To remove the cover, grasp the rear edge and pull up. See Hood Opening and Closing on page 28 for more information.

---

# Vehicle Fire

## Firefighting

---

 **WARNING:** Always assume High-Voltage (HV) systems to be energized. During firefighting activities, including overhaul, avoid contact with HV components. Cutting of HV components may cause an arc flash potentially severely injuring a firefighter.

 **Note:** Only use water to extinguish the battery pack. Submerging the vehicle is not recommended.

**The below recommendations are from the Energy Security Agency (ESA), leaders in Electric Vehicle (EV) fire safety and destructive testing of lithium-ion batteries.**

**The views and opinions Below are not those of LUCID MOTORS. Energy Security Agency (ESA) has determined the following after research and/or testing of the referenced vehicle.**

**Call the ESA for real time guidance anytime at (+1) 855-ESA-SAFE.**

**IMPORTANT: Fires involving Lithium-ion batteries and/or HV components may require copious amounts of water to manage. It is the recommendation of the Energy Security Agency to take a defensive firefighting approach and allow the vehicle to burn in a controlled manner and protect exposures, when possible. See the following sections for interacting with potential fire conditions for the Lucid Air.**

## Scene Size Up

---

1. Necessary Equipment
  - a. Don All Full Structural Personal Protective Equipment (PPE)

- b. Full Self-Contained Breathing Apparatus (SCBA)
  - c. Thermal Imaging Camera (TIC)
  - d. 4 Gas Monitor(s) or Atmospheric Monitor for CO
2. Establish a HOT ZONE

- a. Must be a 75-Foot / 23 Meters Radius Hot Zone
  - b. Recommended to Have Atmospheric Monitoring and Thermal Imaging Present

3. Determine Priorities of the Fire

- a. Is Life Safety at Risk? See Firefighting Guidelines
  - b. Is There the Ability to Let the Vehicle Burn in a Safe, Controlled Manner?

4. Water Supply

- a. ESA DOES NOT recommend using FOAM or other agents to extinguish a lithium-ion battery fire in the Lucid Air.
  - b. If necessary, an ABC extinguisher can be used to mitigate the fire conditions only for a short period of time. ABC and/or foam may be used on non-battery components of the vehicle.
  - c. A direct attack (especially if access to inside the pack is not available), has the potential to require large amounts of water.

## Hazardous Conditions

---

1. Electric vehicles present unique hazards that are associated with the high-voltage system: these are grouped into chemical, electrical, and thermal hazards.

2. Assume the high voltage (HV) system to be energized during all interactions.
  - a. The HV electrical system is powered with 900 volts of DC power. NEVER make contact with the HV battery or HV components, as it can result in electrical shock or arc. HV systems can remain charged for up to 10 minutes after being powered down or disabled. High-voltage stranded energy is always present in the high voltage battery.
3. Assume smoke conditions to be flammable, explosive, and toxic.
  - a. Natural or mechanical ventilation may be necessary to manage gas levels.
4. Off-Gassing
  - a. When the battery is off-gassing, it will produce a white toxic gas cloud that can be differentiated from smoke by the utilization of a 4-gas monitor(s).
  - b. These gasses can accumulate inside of the vehicle at levels above the Lower Explosive Limit (LEL), especially if the vehicle is still relatively airtight and the glass and doors have not been opened or compromised.
  - c. Extreme caution should be taken prior to any ventilation attempts or opening of doors or windows on the vehicle, because introducing fresh air may bring the atmospheric conditions back into the explosive range and result in an explosion if a fire or other ignition sources are present.
  - d. The off-gas can contain detectable levels of Hydrogen Fluoride (HF), Hydrogen Chloride (HCl), Hydrogen Cyanide (HCN), and other hydrocarbons and Volatile Organic Compounds (VOCs) during the inception and growth phases that will pose an inhalation hazard. Full firefighter personal protective equipment and SCBA should be utilized until gas levels are confirmed to be at a safe level. An increase in Carbon Monoxide (CO) readings indicate the presence of off-gassing and thermal runaway, (before and during active burning), of the lithium-ion battery cells. During active burning, the 4-gas monitor may show Hydrogen Sulfide (H<sub>2</sub>S) and Hydrogen Cyanide (HCN) from cross sensitivity of the Li-ion battery and vehicle synthetics producing Hydrogen (H).
5. Individual Battery Cells
  - a. Individual cells have the potential to explode, catch fire, and become separated from the packs during extreme collisions or when overheated, and the batteries may scatter over the incident scene as a result.
  - b. Structural PPE will protect firefighters from these cells if they become projectiles.
  - c. Contact ESA or call (+1) 855-ESA-SAFE for the handling of individual loose batteries.
6. Electrolyte Leak
  - a. A cell will not leak or vent under normal operating conditions. However, cell leakage or venting could occur if the cell is overheated or mechanically,

---

electrically, or physically mishandled/damaged.

- b. The electrolyte contained within the lithium cells can cause severe irritation to the respiratory tract, eyes, and skin.
- c. Violent cell venting can result in a room full of either corrosive or flammable vapors. All proper precautions should be taken to limit exposure to the electrolyte vapor.

The following actions should be taken if electrolyte leaks from a cell:

- Evacuate and isolate all areas that may be potentially affected by the gas.
- Ventilation should be initiated if you are in a confined area or indoors, and continued until the cell is removed from the area and pungent odor is no longer detectable.
- Allow the cell to cool to ambient temperature before handling if it has vented as a result of excessive heating.
- Have fire extinguishment equipment nearby (hose line, water bucket).
- Put on all PPE and remove the cell to a well-ventilated area.
- Cover any spilled fluid on the ground with dry earth, dry sand, or other non-combustible material.
- Place small amounts of batteries and dry non-combustible materials into ventilated plastic buckets.
- Batteries may be placed in water or dry non-combustible material; water will result in discharging cells that may produce thermal events. Dry

non-combustible material will isolate thermal events and not discharge cells. Make sure there is 1 part battery to 3 parts dry non-combustible material/water in buckets.

- Move the battery to a dry, well-ventilated area.
- Dispose it in accordance with applicable local, state, and federal regulations.
- Contact the ESA for additional handling and transportation guidelines for damaged battery components.

## 7. Coolant

- High voltage system components are liquid-cooled with a typical glycol-based automotive coolant. If damaged, this orange coolant can leak out of the high voltage battery.

## 8. Water Runoff

- Assume runoff from firefighting operations may have the potential to be contaminated, just like an internal combustible engine car fire. Consider utilizing dikes, dams, absorbent socks, and other measures to limit runoff.

## 9. Thermal Dangers

- a. The exposure to heat and flames can weaken the airbag inflators, stored gas inflation cylinders, gas struts, and other components, potentially leading to unexpected and excessive heat that may result in the explosion of the inflation cylinder.
- b. Lithium-ion fires produce significantly higher levels of heat compared to standard vehicle fires. Direct flame exposure can result in

serious injury or death and structural turnout gear may not provide adequate protection to prolonged exposure. Special precautions should be taken by emergency personnel to avoid direct flame exposure.

Firefighting

**Firefighting Operations**

1. Defensive Fire

- a. The ESA recommends taking a defensive firefighting approach and allowing the vehicle to burn if life safety and exposure protection can be maintained. Exposures and atmospheric conditions should be protected and managed throughout the event.
- b. Chemicals released during a fire or explosion will be in a gaseous form and primarily pose an inhalation hazard. These gasses can become acids if water is used in extinguishing the flames, potentially causing skin irritation. See Section 4 of Hazardous Conditions on page 246.

2. Transitional Attack

- a. The only effective suppression must have a direct flow of water into the battery compartment and any involved HV components, if it is necessary to extinguish the fire for life safety or potential exposures. ABC extinguishers and/or foam may be used on non-battery components.
- b. Use a combination nozzle when attacking the fire to provide maximum versatility for flow patterns to address the fire condition and source.
- c. Fire departments must flow water into the vent points or openings created by the fire

within the battery pack after the initial knock down. Use a ¼ open bail or comparable amounts of water to fill the vent points. The manufactured vent point will not be accessible in Lucid Air. Use openings created by the fire/accident. Do not puncture the battery.

- d. Some circumstances may call for technician level-lifting techniques to expose vent points.
- e. Water should be applied inside the battery pack for enough time to properly cool the thermal event and stop thermal runaway. Water should also be used to cool the battery until it shows a thermal reading of below 200°F (93°C). An atmospheric monitor should be used to differentiate between steam and smoke once this temperature has been reached. Carbon monoxide (CO) should present itself at or below 50 ppm and declining before cooling is stopped.
- f. It should be assumed that the pack may reignite or go back into thermal runaway after cooling efforts are deemed to be adequate. Vehicle movement is a major mechanism of reignition. The battery should be checked for carbon monoxide (CO) and temperature after any movement.
- g. Consider that battery cells in thermal runaway may take time to heat the exterior of the pack and reveal a heat signature when using a thermal imaging camera to detect heat buildup on the exterior of the pack.
- h. The amount of time that it takes for a heat signature to appear on a Lucid battery pack may be extended due to a protective composite plate between the

---

battery cells and the exterior enclosure.

- i. NEVER attempt to create vent holes in the battery pack.
3. Fire in an Enclosed Structure
- a. Assume smoke conditions to be flammable, explosive, and toxic.
    - Assume that fire conditions can start at any time if off-gassing is present. See Section 4 of Hazardous Conditions on page 246.
  - b. Extinguish the initial fire conditions via the application of water or another available agent.
  - c. Try to remove the vehicle from a garage or enclosed space using a winch, come-along, or another mechanical device. Attachment should be made to a component isolated from high-voltage components.
  - d. See the above directions for firefighting techniques once the vehicle is removed from the structure.

After Firefighting Suppression is Complete

---

#### 1. Monitoring

- a. The battery must be monitored with a TIC for a minimum of 45 minutes after the last application of water.
- b. The battery must remain below 200°F / 93°C to safely be released for transport.
- c. Batteries over 200°F / 93°C have the potential to re-ignite.
- d. Reengage in cooling operations if the battery is showing trends of increasing temperature, a heat signature of over 200°F / 93°C is detected, OR **hot spots** are

seen through a thermal imaging camera.

#### 2. Transferring to Tow Operators

- a. The risk of battery re-ignition remains present for hours or even days after an incident. There is still a potential for re-ignition, even if fire was present and extinguished by the methods listed above.
- b. The Authority Having Jurisdiction (AHJ) must inform the tow operator of the need to perform a risk assessment on the vehicle before they transfer responsibility of the vehicle, by calling the Energy Security Agency (ESA) at (+1) 855-ESA-SAFE.
- c. The vehicle should be stored 50 feet / 15 meters away from all exposures after a fire event or whenever deemed necessary by the ESA. Barrier isolation can also be used to protect exposures.
- d. Like all electric vehicles, a Lucid Air that has experienced a fire event or collision that has compromised the high-voltage battery may pose a fire risk if moved. Limit the movement of the vehicle after a collision or fire because vehicle movement is a major mechanism of reignition. Furthermore, the battery should be checked for CO and temperature after any movement.
- e. One side of the vehicle should be elevated to allow water to drain from the high-voltage battery pack if the vehicle has been exposed to large amounts of water or the pack has been flooded.
- f. The AHJ must ensure that an ESA Risk Analysis Placard (RAP) sticker is placed on the vehicle following an

assessment to determine proper storage conditions and safety concerns.

 Note: Call (+1) 855-ESA-SAFE for real-time support for firefighting/rescue operations involving the Lucid Air. A rescue specialist will be available 24/7 to answer any questions.

14

# Consumer Information



# New Vehicle Limited Warranty

## Warranty Information

---

Lucid's New Vehicle Limited warranty terms can be found here: <http://www.lucidmotors.com/legal#warranty>.

---

# Customer Care

## Contacting Lucid Motors

---

Please have the following details available when contacting Lucid Motors. They are essential to effectively and efficiently answer your questions and/or resolve your concerns:

- Owner's Name and Address
- Owner's Telephone Number
- Vehicle Identification Number (VIN)

Contact Lucid Motors using the information for your warranty region shown earlier in this section or as follows:

### **USA**

Lucid Motors

7373 Gateway Blvd

Newark, CA 94560

USA

Phone: **+1 (888) 995-8243** (24 hours)

E-mail: [customercare@lucidmotors.com](mailto:customercare@lucidmotors.com)  
(24 hours)

For updates and additional information about your vehicle, visit the owner resources section of the Lucid Motors website: [www.lucidmotors.com](http://www.lucidmotors.com)

### **Canada**

Lucid Motors Canada ULC

Suite 2300, Bentall 5, 550 Burrard Street  
Vancouver BC, V6C 2B5

Phone: 1-888-99 LUCID  
(1-888-995-8243)

---

# Reporting Safety Defects

Reporting Safety Defects

---

+1-800-333-0510

## United States

You should immediately inform the National Highway Traffic Safety Administration (NHTSA) and **Lucid Motors** if you believe that your vehicle has a defect that could cause a crash, injury, or death.

If NHTSA receives similar complaints, it may open an investigation. Furthermore, it may order a recall and remedy campaign if it finds that a safety defect exists in a group of vehicles. However, NHTSA cannot become involved in individual problems between you and **Lucid Motors**.

To contact NHTSA, you may call the Vehicle Safety Hotline toll-free at:

1-888-327-4236 (TTY: 1-800-424-9153);  
go to <https://www.nhtsa.gov/report-a-safety-problem#index> or write to:

Administrator

National Highway Traffic Safety  
Administration

1200 New Jersey Avenue SE

Washington, DC 20590

You can also obtain other information  
about motor vehicle safety from:

<http://www.nhtsa.gov>

## Canada

You should immediately inform Transport Canada and **Lucid Motors** if you believe that your vehicle has a defect that could cause a crash, injury, or death.

To contact Transport Canada, call their toll-free number:

---

# Vehicle Recycling

## High-Voltage Battery Recycling Process

---

 **WARNING:** Attempting to disconnect or remove the battery pack without the proper training, tools, and equipment is highly dangerous and could result in serious injury or death.

Your vehicle is equipped with a liquid-cooled lithium ion (Li-ion) high-voltage battery pack. This battery pack must be properly recycled when it has been damaged or reached the end of its service life.

Contact a **Lucid Service Center** immediately if the vehicle is no longer able to retain a charge or turn on or if it has been involved in a collision or submersion. Have a Lucid Service Center or a **Lucid**-approved technician remove the battery pack from the vehicle as soon as possible. **Do not attempt to disconnect or remove the battery pack yourself.**

**Lucid Service Centers** will manage the damaged or depleted battery pack and, in accordance with Lucid's requirements, contact a qualified recycling company for recycling and disposal.

 **ENVIRONMENTAL:** Do not dispose of the battery pack yourself, as arbitrary disposal can cause pollution and harm to the environment.

Follow the information and requirements below:

1. Personnel: The HV battery removal operation must be performed by a **Lucid Service Center** technician or a **Lucid**-approved professional.
2. Transportation: The battery pack is classified as a hazardous material under Class 9 dangerous goods. If it is removed from the vehicle, it must be labeled, documented, and

transported by licensed vehicles that meet all requirements for transporting Class 9 dangerous goods.

3. Storage: The removed battery pack should be stored in an environment that is protected from extreme temperatures and high humidity. Do not expose the removed battery pack to flammable materials, heat sources, water sources, or other hazards.

Please contact a **Lucid Service Center** for questions or further details on the recycling and disposal of a battery pack. To locate a **Lucid Service Center**, please visit [www.lucidmotors.com](http://www.lucidmotors.com) for the latest information.

# FCC, FDA, and ISED Compliance

## FCC and ISED Certification

Component	Manufacturer	Model	Operating Frequency (MHz)	FCC ID / ISED ID	Maximum Transmit Power
Bluetooth® Vehicle Key	Pektron Group Ltd	A-0820G01	2402-2480 MHz	AQO013  IC: 10176A-013	2402-2480MHz:0.8mW / -0.969dBm
Access Control Module BTLE/LF Node	Pektron Group Ltd	A-0819G03, A-0819G06	125 KHz, 2402-2480 MHz	AQO012  IC: 10176A-012	2402-2480MHz: 1.3 mW / 1.14dBm
Access Control Module BTLE/LF/NFC Node	Pektron Group Ltd	A-0819G02, A-0819G07	125 KHz, 13.56 MHz, 2402-2480 MHz	AQO011  IC: 10176A-011	2402-2480MHz:1.8 mW / 2.55dBm
Center Console Controller	Lucid USA, Inc.	P11-K2B000	2402-2480 MHz, 5180.0-5240.0 MHz, 5260-5320 MHz, 5500.0-5700.0 MHz, 5745.0-5825.0 MHz	2AXZJ-K2B000  IC: 27970-K2B000	2.4GHz : 47.8mW / 16.8dBm 5GHz : 200mW / 23dBm
Homelink Universal Garage Door Transmitter	Gentex Corp	ADHL5D	286-440 MHz, 902-928 MHz	NZLADHL5D  IC: 4112A-ADHL5D	902.25-926.75MHz: 0.78mW / -1.08dBm
Long-Range Radar	Automotive Distance Control Systems GmbH	ARS5-B	76-77 GHz	OAYARS5B  IC: 4135A-SRR5-B	1905 mW / 32.8dBm
Wireless Phone Charger	JVIS USA LLC	99237200	119.6 KHz	2AZX6-1LCID350001  IC: 27404-1LCID350001	N/A
Short Range Radar	Automotive Distance Control Systems GmbH	SRR5-B	76-77 GHz	OAYSRR5B  IC: 4135A-ARS5-B	258.23 mW / 24.12dBm

Component	Manufacturer	Model	Operating Frequency (MHz)	FCC ID / ISED ID	Maximum Transmit Power
Telematics Control Unit	Lucid USA, Inc.	PII-K29000	2412.0-2462.0 MHz, 2502.5-2567.5 MHz, 5180.0-5240.0 MHz, 5745.0-5825.0 MHz, 699.7-715.3 MHz, 779.5-784.5 MHz, 824.2-848.8 MHz, 1710.7-1754.3 MHz, 1850.2-1909.8 MHz	2AXZJ-CTX0700  IC: 27970- CTX0700	LTE Band 12:699.7-715.3MHz z: 20.4.6mW / 23.11dBm 700.5-714.5MHz: 171.4mW / 22.34dBm704.0-71 1.0MHz: 194.1mW / 22.88dBm779.5-78 4.5MHz: 214.5mW / 23.31dBmLTE Band 13:782.0-782.0MHz z: 255.9mW / 24.08dBmGSM 850:824.2-848.8 MHz: 1014.0mW / 30.06dBmLTE Band 5:824.7-848.5MHz z: 202.3mW / 23.06dBmWCDM A Band V:826.4-846.6MHz z: 265.0mW / 24.199dBm829.0- 844.0MHz: 191.0mW / 22.81dBmPCS 1900:1850.2-1909. 8MHz 615.0mW / 27.89dBmLTE Band 2:1850.7-1909.3MHz Hz: 129.4mW / 21.12dBm1851.5-19 08.5MHz: 152.4mW / 21.83dBm1860.0-1 900.0MHz: 138.0mW / 21.40dBmLTE Band 41710.7-1754.5MHz z: 142.6 mW / 21.54dBm1715.0-17 50.0MHz: 117.5 mW / 20.70dBm1720.0-1 745.0MHz: 127.6 mW / 21.06dBmWCDM A Band IV:1712.4-1752.6MHz Hz: 184.1mW / 22.65dBmWCDM Ad Band II:1852.4-1907.6MHz Hz: 164.4mW / 22.16dBmLTE Band 7:2505.0-2565.0MHz Hz: 50.5mW / 17.035dBm2510.0- 2560.0MHz: 47.5mW / 16.77dBmWiFi/ BT2412.0-2462.0 MHz: 194.5mW / 22.89dBm5180.0- 5240.0MHz 26.1mW / 14.17dBm5745.0-5 825.0MHz 67.6mW / 18.30dBm

Component	Manufacturer	Model	Operating Frequency (MHz)	FCC ID / ISED ID	Maximum Transmit Power
Telematics Control Unit	Lucid USA, Inc.	P11-K290G0	2412.0-2462.0 MHz, 2502.5-2567.5 MHz, 5180.0-5240.0 MHz, 5745.0-5825.0 MHz, 699.7-715.3 MHz, 779.5-784.5 MHz, 824.2-848.8 MHz, 1710.7-1754.3 MHz, 1850.2-1909.8 MHz	2AXZJ-CTX0710  IC: 27970-CTX0710	LTE Band 12701.5-713.5 MHz: 216.0 mW / 25.34dBm704.0-712.5 MHz: 258.0 mW / 24.12dBmLTE Band 13782.0-782.0 MHz: 308.0 mW / 24.89dBmGSM 850:824.2-848.8 MHz: 2795.0 mW / 34.46dBmLTE Band 5:825.5-847.5 MHz: 376.7 mW / 25.76dBm829.0-844.0 MHz: 441.6 mW / 26.45dBmWCDMA Band V:826.4-846.6 MHz: 284.0 mW / 24.53dBmPCS 1900:1850.2-1909.8 MHz: 875.0 mW / 29.41dBmWCDMA Ad Band II:1852.4-1907.6 MHz: 182.0 mW / 22.6dBmLTE Band 2:1857.5-1902.5 MHz: 165.2 mW / 22.18dBm1860.0-1900.0 MHz: 200.9 mW / 23.05dBmLTE Band 41711.5-1753.5 MHz: 176.2 mW / 22.46dBm1715.0-1750.0 MHz: 212.3 mW / 23.27dBm1720.0-1745.0 MHz: 194.1 mW / 22.88dBmWCDMA Band IV:1712.4-1752.6 MHz: 174.0 mW / 22.41dBmLTE Band 661717.5-1772.5 MHz: 151.0 mW / 21.79dBm1720.0-1770.0 MHz: 182.0 mW / 22.6dBmLTE Band 7:2510.0-2560.0 MHz: 68.0 mW / 18.35dBmWiFi/ BT2412.0-2462.0 MHz: 91.2 mW / 19.6dBm5210.0-5210.0 MHz: 15.0 mW / 11.76dBm5745.0-5825.0 MHz: 39.5 mW / 15.97dBm
Tire Pressure Monitoring System	Continental Automotive GmbH	TIS-01	433.92 MHz	KR5TIS-01  IC: 7812D-TIS01	0.00202 mW / -26.95dBm

 Note: ISED compliance: CAN ICES-002/NMB-002

---

**FCC and ISED Notes: Wireless Charger-JVIS USA****FCC ID: 2AZX6-1LCID350001****IC: 27404-1LCID350001**

This device complies with part 15 of the FCC Rules. Operation is subject to the following two conditions:

1. This device may not cause harmful interference.
2. This device must accept any interference received, including interference that may cause undesired operation.

Changes or modifications not expressly approved by the party responsible for compliance could void the user's authority to operate the equipment.

This equipment has been tested and found to comply with the limits for a Class B digital device, pursuant to part 15 of the FCC Rules. These limits are designed to provide reasonable protection against harmful interference in a residential installation. Failure to properly follow the instructions for installation and use of this equipment may result in the emission of radio frequency energy that could interfere with radio communications and potentially cause harm. It cannot be guaranteed that interference will not occur in a specific installation. If the equipment does cause harmful interference to radio or television reception, which can be detected by toggling the equipment's power, the user is advised to attempt to remedy the interference by implementing one or more of the measures listed below:

- Reorient or relocate the receiving antenna.
- Increase the separation between the equipment and receiver.
- Connect the equipment into an outlet on a circuit different from that in which the receiver is connected to.
- Consult the dealer or an experienced radio/TV technician for help.

**FCC and ISED Notes: Interior Radar****FCC ID: A8DAIRGEN-1****IC ID: 419B -AIRGEN****FCC Interference Statement (Part 15.105 (b))**

This equipment has been tested and found to comply with the limits for a Class B digital device, pursuant to Part 15 of the FCC Rules. These limits are designed to provide reasonable protection against harmful interference in a residential installation. Failure to properly follow the instructions for installation and use of this equipment may result in the emission of radio frequency energy that could interfere with radio communications and potentially cause harm. It cannot be guaranteed that interference will not occur in a specific installation. If the equipment does cause harmful interference to radio or television reception, which can be detected by toggling the equipment's power, the user is advised to attempt to remedy the interference by implementing one or more of the measures listed below:

- Reorient or relocate the receiving antenna.



- Increase the separation between the equipment and receiver.
- Connect the equipment into an outlet on a circuit different from that in which the receiver is connected to.
- Consult the dealer or an experienced radio/TV technician for help.

**FCC Part 15 Clause 15.21**

Changes or modifications not expressly approved by the party responsible for compliance could void the user's authority to operate the equipment

**FCC Part 15.19(a)**

This device complies with part 15 of the FCC Rules. Operation is subject to the following two conditions: (1) This device may not cause harmful interference, and (2) this device must accept any interference received, including interference that may cause undesired operation.

**ISED RSS-Gen Notice**

This device contains license-exempt transmitter(s)/receiver(s) that comply with Innovation, Science and Economic Development Canada's license-exempt RSS(s). Operation is subject to the following two conditions:

- This device may not cause interference.
- This device must accept any interference, including interference that may cause undesired operation of the device.

L'émetteur/récepteur exempt de licence contenu dans le présent appareil est conforme aux CNR d'Innovation, Sciences et Développement économique Canada applicables aux appareils radio exempts de licence. L'exploitation est autorisée aux deux conditions suivantes :

L'appareil ne doit pas produire de brouillage;

L'appareil doit accepter tout brouillage radioélectrique subi, même si le brouillage est susceptible d'en compromettre le fonctionnement.

**ISED Canada ICES-003 Compliance Label**

CAN ICES-3 (B)/NMB-3(B)

**FCC/ISED RF Exposure requirements:**

In order to comply with FCC/ISED RF Exposure requirements, this device must be installed to provide at least 20 cm separation from the human body at all times.

Pour être conforme avec les exigences sur les Radios Fréquence contenues dans le FCC/ISED, l'appareil doit être installé de sorte à être en permanence à au moins 20 cm de distance du corps humain.

**FCC and ISED Notes: TPMS System – Continental Automotive GmbH****FCC ID: KR5TIS-01**

---

**IC: 7812D-TIS01****FCC Statements**

FCC § 15.19 Labelling requirements

This device complies with part 15 of the FCC Rules and Industry Canada license-exempt RSS standard(s). Operation is subject to the following two conditions:

1. This device may not cause harmful interference.
2. This device must accept any interference received, including interference that may cause undesired operation.

FCC § 15.21 Information to user

Changes or modifications not expressly approved by the party responsible for compliance could void the user's authority to operate the equipment.

ISED RSS-Gen Notice

This device contains license-exempt transmitter(s)/receiver(s) that comply with Innovation, Science and Economic Development Canada's license-exempt RSS(s). Operation is subject to the following two conditions: This device may not cause interference, and this device must accept any interference, including interference that may cause undesired operation of the device.

L'émetteur/récepteur exempt de licence contenu dans le présent appareil est conforme aux CNR d'Innovation, Sciences et Développement économique Canada applicables aux appareils radio exempts de licence. L'exploitation est autorisée aux deux conditions suivantes: L'appareil ne doit pas produire de brouillage; L'appareil doit accepter tout brouillage radioélectrique subi, même si le brouillage est susceptible d'en compromettre le fonctionnement.

**FCC and ISED Notes: Universal Garage Door Opener Transmitter – Gentex Corp.**

**FCC ID: NZLADHL5D**

**IC: 4112A-ADHL5D**

**FCC (USA) and IC (Canada):**

This device complies with FCC rules part 15 and Industry Canada RSS-210. Operation is subject to the following two conditions:

1. This device may not cause harmful interference.
2. This device must accept any interference that may be received, including interference that may cause undesired operation.

 **WARNING:** The transmitter has been tested and complies with FCC and IC rules. Changes or modifications not expressly approved by the party responsible for compliance could void the user's authority to operate the device.

This equipment complies with FCC radiation exposure limits set forth for an uncontrolled environment. End users must follow the specific operating instructions for satisfying RF exposure compliance. This transmitter must be at least 20cm from the user and must not be co-located or operating in conjunction with any other antenna or transmitter.

#### ISED RSS-Gen Notice

This device contains license-exempt transmitter(s)/receiver(s) that comply with Innovation, Science and Economic Development Canada's license-exempt RSS(s). Operation is subject to the following two conditions:

1. This device may not cause interference.
2. This device must accept any interference, including interference that may cause undesired operation of the device.

L'émetteur/récepteur exempt de licence contenu dans le présent appareil est conforme aux CNR d'Innovation, Sciences et Développement économique Canada applicables aux appareils radio exempts de licence. L'exploitation est autorisée aux

deux conditions suivantes:

1. L'appareil ne doit pas produire de brouillage;
2. L'appareil doit accepter tout brouillage radioélectrique subi, même si le brouillage est susceptible d'en compromettre le fonctionnement.

#### **FCC and ISED Notes: Long Range Radar - Automotive Distance Control Systems GmbH**

**FCC ID: OAYARS5B**

**IC: 4135A-ARS5B**

#### **Canada only:**

This device complies with Industry Canada license-exempt RSS standard(s). Operation is subject to the following two conditions:

1. This device may not cause harmful interference.
2. This device must accept any interference received, including interference that may cause undesired operation.

Le présent appareil est conforme aux CNR d'Industrie Canada applicables aux appareils radio exempts de licence. L'exploitation est autorisée aux deux conditions suivantes:

1. L'appareil ne doit pas produire de brouillage, et
2. L'utilisateur de l'appareil doit accepter tout brouillage radioélectrique subi, même si le brouillage est susceptible d'en compromettre le fonctionnement.

#### **Canada and US:**

Radiofrequency radiation exposure Information: This equipment complies with FCC and IC radiation exposure limits set forth for an uncontrolled environment. This equipment should be installed and operated with a minimum distance of 20 cm between the radiator and your body.

---

This transmitter must not be co-located or operating in conjunction with any other antenna or transmitter.

Cet équipement est conforme aux limites d'exposition aux rayonnements IC établies pour un environnement non contrôlé. Cet équipement doit être installé et utilisé avec un minimum de 20 cm de distance entre la source de rayonnement et votre corps.

**US: FCC Notice**

Changes or modifications not expressly approved by the party responsible for compliance could void the user's authority to operate the equipment.

**FCC and ISED Notes: Short Range Radar Model: SRR5-B - Automotive Distance Control Systems GmbH**

**FCC ID: OAYSRR5B**

**IC: 4135-SRR5B**

**Canada and US**

Radiofrequency radiation exposure Information:

This equipment complies with FCC radiation exposure limits set forth for an uncontrolled environment. This equipment should be installed and operated with a minimum distance of 20 cm between the radiator and your body.

Cet équipement est conforme aux limites d'exposition aux rayonnements IC établies pour un environnement non contrôlé. Cet équipement doit être installé et utilisé avec un minimum de 20 cm de distance entre la source de rayonnement et votre corps.

This transmitter must not be co-located or operating in conjunction with any other antenna or transmitter.

**Canada only:**

This device complies with Industry Canada licence-exempt RSS standard(s). Operation is subject to the following two conditions:

1. This device may not cause harmful interference.
2. This device must accept any interference received, including interference that may cause undesired operation.

Le présent appareil est conforme aux CNR d'Industrie Canada applicables aux appareils radio exempts de licence. L'exploitation est autorisée aux deux conditions suivantes:

1. L'appareil ne doit pas produire de brouillage, et
2. L'utilisateur de l'appareil doit accepter tout brouillage radioélectrique subi, même si le brouillage est susceptible d'en compromettre le fonctionnement.

**FCC Notice**

Changes or modifications not expressly approved by the party responsible for compliance could void the user's authority to operate the equipment.

**FCC and ISED Note: Bluetooth Vehicle Key, ACM Node BTLE/LF, ACM Node BTLE/LF/NFC - Pektron Group**

**FCC ID: AQQ013, AQQ012, AQQ011**

**IC: 10176A-013, 10176A-012, 10176A-011**

#### **For Canada**

This device complies with Industry Canada's license-exempt RSSs.

Operation is subject to the following two conditions:

1. This device may not cause harmful interference.
2. This device must accept any interference received, including interference that may cause undesired operation.

Le présent appareil est conforme aux CNR d'Industrie Canada applicables aux appareils radio exempts de licence. L'exploitation est autorisée aux deux conditions suivantes:

1. L'appareil ne doit pas produire de brouillage, et
2. L'utilisateur de l'appareil doit accepter tout brouillage radioélectrique subi, même si le brouillage est susceptible d'en compromettre le fonctionnement.

#### **For US**

This equipment complies with FCC radiation exposure limits set forth for an uncontrolled environment. End-users must follow the specific operating instructions for satisfying RF exposure compliance. This transmitter must not be co-located or operating in conjunction with any other antenna or transmitter.

Changes or modifications not expressly approved by the party responsible for compliance could void the user's authority to operate the equipment.

**FCC and ISED Notes: Telematics Control Unit– Lucid USA, Inc.**

**FCC ID: 2AXZJ-CTX0700, 2AXZJ-CTX0710**

**IC: 27970-CTX0700, 27970-CTX0710**

#### **FCC Interference Statement**

This equipment has been tested and found to comply with limits for a Class B digital device, pursuant to Part 15 of the FCC rules. These limits are designed to provide reasonable protection against harmful interference in a residential installation. Failure to properly follow the instructions for installation and use of this equipment may result in the emission of radio frequency energy that could interfere with radio communications and potentially cause harm. It cannot be guaranteed that interference will not occur in a specific installation. If the equipment does cause harmful interference to radio or television reception, which can be detected by toggling the equipment's power, the user is advised to attempt to remedy the interference by implementing one or more of the measures listed below:

- Reorient or relocate the receiving antenna.
- Increase the separation between the equipment and receiver.

- 
- Connect the equipment into an outlet on a circuit different from that in which the receiver is connected to.
  - Consult the dealer or an experienced radio/TV technician for help.

FCC Caution: Any changes or modifications not expressly approved by the party responsible for compliance could void the user's authority to operate this equipment.

This device complies with Part 15 of the FCC Rules. Operation is subject to the following two conditions:

1. This device may not cause harmful interference.
2. This device must accept any interference received, including interference that may cause undesired operation.

This device and its antenna(s) must not be co-located or operating in conjunction with any other antenna or transmitter.

For products available in the USA/Canada market, only channel 1-11 can be operated. Selection of other channels is not possible.

### **IC Canada**

This device contains licence-exempt transmitter(s)/receiver(s) that comply with Innovation, Science and Economic Development Canada's licence-exempt RSS(s). Operation is subject to the following two conditions

1. This device may not cause interference.
2. This device must accept any interference, including interference that may cause undesired operation of the device.

L'émetteur/récepteur exempt de licence contenu dans le présent appareil est conforme aux CNR d'Innovation, Sciences et Développement économique Canada applicables aux appareils radio exempts de licence. L'exploitation est autorisée aux deux conditions suivantes:

1. L'appareil ne doit pas produire de brouillage;
2. L'appareil doit accepter tout brouillage radioélectrique subi, même si le brouillage est susceptible d'en compromettre le fonctionnement.

### **IMPORTANT NOTE:**

FCC Radiation Exposure Statement:

This equipment complies with FCC radiation exposure limits set forth for an uncontrolled environment. This equipment should be installed and operated with a minimum distance of 25cm between the radiator and your body.

For Outdoor access point operating in the band 5.15-5.25 GHz Professional Installation instruction 1. Professional installer: this product is designed for specific application and needs to be installed by trained personnel. The general user shall not attempt to install or change the setting. 2. External Antenna: use only the antenna(s) that have been approved by the manufacturer. The non-approved antenna(s) may produce unwanted spurious or excessive RF transmitting power that may lead to the violation of FCC limit

and is prohibited. Warning: Please carefully select the installation position and ensure that the final output power does not exceed the limit set forth in relevant rules.

#### IC Radiation Exposure Statement:

This equipment complies with IC RSS-102 radiation exposure limits set forth for an uncontrolled environment. This equipment should be installed and operated with minimum distance 25cm between the radiator and your body.

Cet équipement est conforme aux limites d'exposition aux rayonnements IC établies pour un environnement non contrôlé. Cet équipement doit être installé et utilisé avec un minimum de 25cm de distance entre la source de rayonnement et votre corps

The transmitter module may not be co-located with any other transmitter or antenna.

Le module émetteur peut ne pas être coimplanté avec un autre émetteur ou antenne.

#### CAN ICES-3 (B)/NMB-3(B)

The Country Code Selection feature is disabled for products marketed in the US/Canada. For product available in the USA/Canada market, only channel 1~11 can be operated. Selection of other channels is not possible.

Pour les produits disponibles aux Etats-Unis / Canada du marché, seul le canal 1a 11 peuvent être exploités. Sélection d'autres canaux n'est pas possible.

#### FCC and ISED Notes: Center Console Controller – Lucid USA, Inc

##### **FCC ID: 2AXZJ-K2B000**

##### **IC: 27970-K2B000**

#### FCC Interference Statement

This device complies with part 15 of the FCC Rules. Operation is subject to the following two conditions:

1. This device may not cause harmful interference.
2. This device must accept any interference received, including interference that may cause undesired operation.

Changes or modifications made to this equipment not expressly approved by Lucid Motors, Inc. may void the FCC authorization to operate this equipment.

#### FCC Radiation Exposure Statement

This equipment complies with FCC radiation exposure limits set forth for an uncontrolled environment. This equipment should be installed and operated with a minimum distance of 25cm between the radiator and your body.

#### **IC Antenna Statement**

Under Industry Canada regulations, this radio transmitter may only operate using an antenna of a type and maximum (or lesser) gain approved for the transmitter by Industry Canada. To reduce potential radio interference to other users, the antenna type and its

---

gain should be so chosen that the equivalent isotropically radiated power (e.i.r.p.) is not more than that necessary for successful communication.

Conformément à la réglementation d'Industrie Canada, le présent émetteur radio peut fonctionner avec une antenne d'un type et d'un gain maximal (ou inférieur) approuvé pour l'émetteur par Industrie Canada. Dans le but de réduire les risques de brouillage radioélectrique à l'intention des autres utilisateurs, il faut choisir le type d'antenne et son gain de sorte que la puissance isotrope rayonnée équivalente (p.i.r.e.) ne dépasse pas l'intensité nécessaire à l'établissement d'une communication satisfaisante.

### **IC Licence exempt**

This device complies with Industry Canada licence-exempt RSS standard(s). Operation is subject to the following two conditions:

- (1) This device may not cause interference.
- (2) This device must accept any interference, including interference that may cause undesired operation of the device.

Le présent appareil est conforme aux CNR d'Industrie Canada applicables aux appareils radio

exempts de licence. L'exploitation est autorisée aux deux conditions suivantes :

- (1) l'appareil ne doit pas produire de brouillage, et
- (2) l'utilisateur de l'appareil doit accepter tout brouillage radioélectrique subi, même si le brouillage est susceptible d'en compromettre le fonctionnement.

### **IC Radiation Exposure Statement**

This equipment complies with ISED radiation exposure limits set forth for an uncontrolled environment. This equipment should be installed and operated with greater than 25cm between the radiator and your body.

Cet équipement est conforme aux limites d'exposition aux rayonnements ISED établies pour un environnement non contrôlé. Cet équipement doit être installé et utilisé à plus de 25cm entre le radiateur et votre corps.

### **Event Data Recorder**

An event data recorder (EDR) is installed in this vehicle, primarily to capture data during certain crash or near-crash scenarios, such as when an airbag is deployed or when the vehicle hits a road obstacle. This data can help to analyze how the vehicle's systems functioned and improve our understanding of the circumstances surrounding the event. The EDR is designed to record data related to vehicle dynamics and safety systems for a short period of time, typically 30 seconds or less. The EDR in this vehicle is designed to record such data as:

- How Various Systems in your Vehicle were Operating
- Whether or not the Driver and Passenger Safety Belts were Buckled/Fastened
- How Far (if at all) the Driver was Depressing the Accelerator and/or Brake Pedal



- How Fast the Vehicle was Traveling

This data can help provide a better understanding of the circumstances in which crashes and injuries occur.

-  **Note:** EDR data are recorded by your vehicle only if a non-trivial crash situation occurs. No data are recorded by the EDR under normal driving conditions, and no personal data, (e.g., name, gender, age, and crash location), are recorded. However, other parties, such as law enforcement, could combine the EDR data with the type of personally identifying data routinely acquired during a crash investigation.

Special equipment is required to read data recorded by an EDR, and access to the vehicle or the EDR is needed. In addition to the vehicle manufacturer, other parties, such as law enforcement, that have the special equipment, can read the information if they have access to the vehicle or the EDR.

### Food and Drug Administration (FDA) Compliance Information

-  **WARNING:** DO NOT attempt to remove, access, or modify the LiDAR unit in this vehicle. The LiDAR unit is a Class I laser device subject to regulation by the FDA. There are NO permitted service or maintenance procedures for your vehicle's LiDAR. If you suspect that the LiDAR unit is not functioning properly, contact Lucid immediately for instructions.

### Vehicle Patents

A list of Lucid Air patents can be found at [www.lucidmotors.com/legal](http://www.lucidmotors.com/legal).

---

# Disclaimers / Warnings

## California Proposition 65

---



**WARNING:** Operating, servicing, and maintaining a passenger vehicle can expose you to chemicals, including phthalates, which are known to the State of California to cause cancer and birth defects, or other reproductive harm. To minimize exposure, wear gloves or wash your hands frequently when servicing your vehicle. For more information, go to [www.P65Warnings.ca.gov/passenger-vehicle](http://www.P65Warnings.ca.gov/passenger-vehicle).

## California Perchlorate Advisory

---

**⚠ WARNING:** Certain components of this vehicle, such as lithium batteries, may contain perchlorate material. Special handling may apply for service or end-of-life disposal. See [www.dtsc.ca.gov](http://www.dtsc.ca.gov).

## Vehicle Telematics

---

Lucid Air is an advanced connected vehicle equipped with a host of advanced electronic control units (ECUs), each responsible for a specific set of features. The features span domains, including controls, safety, Infotainment, chassis, DreamDrive, telematics, etc., contribute to the functionality, performance, safety, and security of the vehicle.

In the process of its operation, each ECU monitors a set of sensors and controls a set of actuators depending on the role of the ECU. As a result, each ECU generates and collects data about the operational state, performance, anomalies, environment conditions, battery and charging-related information, speed, direction, location, etc. The collected data are transmitted to the Lucid cloud services infrastructure on an ongoing basis over cellular

wireless and wireless LAN networks. In addition, a portion of the data may be accessed by the technicians at the service center and stored in the Lucid information databases.

Lucid may use the vehicle data stored in the vehicle, databases in the service centers, and cloud-based infrastructure to enhance its products and services, including but not limited to vehicle maintenance, troubleshooting, timely service recommendations and reminders, additional feature recommendations, research and development, and marketing and business analysis purposes. Lucid Air has the over-the-air (OTA) software update capability to keep the vehicle software current and improved. Lucid may use the vehicle data to update vehicle software improvements OTA to avoid issues proactively before they occur on the vehicle.

Please see Lucid's Vehicle Data Privacy Policy and Privacy Policy for additional details about how Lucid collects and processes data collected from the vehicle.

## Data Recording

---

### Service Data Recording

Service data recorders in your vehicle are capable of collecting and storing diagnostic information about your vehicle. This potentially includes information about the performance or status of various systems and modules in the vehicle, such as the high-voltage battery, electric motors, accelerator, steering, or brakes. A **Lucid Service Center** or other service facilities may access vehicle diagnostic information through a direct connection to your vehicle in order to properly diagnose and service your vehicle.

## Event Data Recording

This vehicle is equipped with an event data recorder (EDR). The main purpose of an EDR is to record, in certain crash or near crash-like situations, such as an air bag deployment or hitting a road obstacle (data that will assist in understanding how a vehicle's systems performed). The EDR is designed to record data related to vehicle dynamics and safety systems for a short period of time (typically 30 seconds or less). The EDR in this vehicle is designed to record data, such as:

- How Various Systems in your Vehicle Were Operating
- Whether or Not the Driver and Passenger Safety Belts Were Buckled/Fastened
- How Far, (If at All), the Driver Was Depressing the Accelerator and/or Brake Pedal
- How Fast the Vehicle was Traveling

This data can help provide a better understanding of the circumstances in which crashes and injuries occur.

 *Note:* EDR data are recorded by your vehicle only if a non-trivial crash situation occurs. No data are recorded by the EDR under normal driving conditions, and no personal data (e.g., name, gender, age, and crash location), are recorded. However, other parties, such as law enforcement, could combine the EDR data with the type of personally identifying data routinely acquired during a crash investigation.

Reading the data recorded by an EDR requires special equipment and access to either the vehicle or the EDR is necessary. In addition to the vehicle manufacturer, other parties that have the special equipment, such as law enforcement, can read the information if they have access to the vehicle or the EDR.

 *Note:* Certain services, such as software updates and other subscriptions, may require the transmission of vehicle data.

# Index

## A

- Accessory Position 73
- Adaptive Cruise Control 114
- Air filter replacement 198
- Airbags 57
  - Obstruction of 61
  - Warning indicator 65
- Alerts and notifications 67
- Anti-Lock Braking System (ABS) 90
- Anti-theft system 33
- Apple CarPlay 151
- Audio
  - Physical controls 145, 146
  - Playing from devices 151
  - Settings 152
- Automatic parking
  - Automatic Park In 131
  - Automatic Park Out 133
  - Distance warning 136

## B

- Batteries (12V)
  - Specifications 234
- Battery (high-voltage) 180
  - Charging 182
  - Emergency disabling 245
  - Specifications 234
- Battery (High-Voltage)
  - Health 180
  - Temperature Limits 180
- Battery (key fob) 20
- Blind Spot Display 130
- Blind Spot Monitoring 129
- Bluetooth®
  - Pairing 160
  - Playing media 151
  - Using a paired phone 161
- Body repairs 206
- Brake fluid 194
- Brakes
  - Anti-Lock Braking System (ABS) 90
  - Brake filling 91
  - Brake pad wear 93
  - Emergency braking 124
  - Lucid Stability Control 96
  - Regenerative braking 91
  - Specifications 230
  - Stopping Mode 92

## C

- Cameras
  - Interior 121
  - Limitations 111
  - Rear view 135
  - Surround view 134
- Car cover 203
- Car Washes 202
- Cargo area
  - Folding the rear seat 39
  - Front 29
  - Pass-through hatch 39
  - Rear 32
- Charge port 182
- Charge Port
  - Light 185
  - Manually Open 183
- Charging 186
  - Instructions 183
  - RangeXchange 184
  - Safety checklist 182
  - Set charge limit 186
  - Status 185
  - Temperature limits 188
  - Vehicle-to-Vehicle 184
- Charging Cable
  - Emergency Manual Release 185
- Charging)
  - Scheduled Charging 187
- Child restraints
  - Automatic Locking Retractor (ALR) 44
- Child safety locks 24
- Child safety seats
  - Booster seats 53
  - Choosing a seat 51
  - Guidelines 49
  - Installation 53
- Cleaning
  - Carpets and Floor Mats 205
  - Displays 204
  - Exterior 201
  - Interior 203
  - Underbody 202
  - Wheels 202
  - Windshield, Windows, and Mirrors 203
  - Wiper Blades 203
- Collision protection 124
- Collision repairs 206
- Collision warning 125–127
- Contact information
  - Lucid Motors 254
  - Lucid Roadside Assistance 236
  - NHTSA 255

- Cross Traffic Protection 127
- Cruise control 114
- Curb Weight 228
- Cut loop 245

## D

### Data

- Event recording 271
- Personal 6
- Service recording 270

### Data Sharing 6

- Delivery mileage 5

### Displays

- Cleaning 204
- Glass Cockpit 14
- Pilot Panel 15
- Rear Center Console Display 16
- Smart Drawer 15

- Distracted Driver Alert 121

### Doors

- Automatic locking and unlocking 24
- Child safety locks 24
- Opening and closing 23
- Opening with no power 24

### Download

- Owner's Manual 169
- Software updates 170

### DreamDrive

- DreamDrive Pro 108
- Features 108
- Limitations 111
- Requirements 114
- Steering wheel controls 113, 114

- Drive 73

- Drowsy Driver Alert 122

## E

### Easy Entry

- Easy Entry & Exit 36

- Emergency braking 124

- Event data recording 271

## F

- Firefighting 246, 249, 250

- Floor mats 205

### Floor Mats

- Cleaning 205

- Forward Collision Warning 125

- Front passenger detection 62–64

- Front suspension specifications 232

- Front Trunk Lid 28

- Frunk Lid 28

## G

- GVWR 228

## H

### Head restraints

- Adjusting 41
- Positioning 41
- Reinstalling 42
- Removing 42

- High Beam Assist 122

- Highway Assist 117

- HomeLink® 165

- Hood 28

- Interior emergency release 30

## I

### Indicator lights

- Airbag 65
- Automatic Emergency Braking 124
- Low tire pressure 221

- Intrusion Alert 33

## K

### Key fob

- Battery replacement 20
- Care instructions 21
- Low battery indicator 20
- Replacement 21
- Using 18

### Key Fob

- Troubleshooting 19

## L

### Label

- Cut loop 245
- Tire and loading information 212
- Vehicle certification 12

- Lane Departure Protection 128

- Load carrying 223

- Locking your vehicle 18

## M

### Maintenance

- Brake fluid 194
- Daily and monthly checks 190
- Seasonal Wheel Changes 199
- Service intervals 192
- Underbody 202

## Maintenance (continued)

- Washer fluid 195
- Wiper blades 196

## Maps 154

- Offline mode 159
- Orientation 158

## Media

- Apps 151
- Physical controls 145, 146
- Playing from devices 151
- Radio 146

## Mirrors

- Blind Spot Display 130
- Blind Spot Monitoring 129

## Mobile Key 18

## N

### Navigation 154

- Offline mode 159
- Search 154

### Near-Field Communication (NFC) card 20

## O

### Overview

- Exterior 8
- Glass Cockpit 14
- Interior 10
- Pilot Panel 15
- Smart Drawer 15
- Steering Wheel 13

## P

### Parking

- Automatic Park In 131
- Automatic Park Out 133
- Distance warning 136

### Phone

- In-Call Options 162

### Phone app 161

### Preconditioning 186

## R

### Radio 146

- SiriusXM 148

### Rear Pedestrian Collision Detection 126

### Rear suspension specifications 233

### Rear view camera 135

### Regenerative braking 91

### Release Notes 3

### Reporting safety defects 255

### Rescue operations

- Firefighting 246, 249, 250

### Roadside Assistance 236

## S

### Safety instructions

- Electrical/high voltage safety 191
- Obstruction of air bags 61

### Seat belts

- Fastening and releasing 44
- In a collision 46
- Reminders 45
- Testing 48
- Wearing correctly 44
- Wearing when pregnant 45

### Seats

- Adjustment 35
- Folding (rear) 39
- Heating (rear) 40
- Heating and ventilation 37
- Massage 37
- Pass-through hatch 39

### Service

- Data recording 270

### Side Airbags 60

### SiriusXM 148

### Snow 219

### Specifications

- 12V battery 234
- Brakes 230
- Front suspension 232
- High-voltage battery 234
- Rear suspension 233
- Steering 229
- Tires 231
- Wheels 231

### Steering specifications 229

### Steering Wheel 13

- Media Controls 145

### Sunshades 27

## T

### Tire and loading information label 212

### Tire care 214

### Tire Identification Number (TIN) 210

### Tire pressure checking 216

### Tire Pressure Monitoring System

- Malfunction 221
- Operation 221

### Tires 209, 210

- Asymmetric 217
- Chains 219
- Degradation 215
- Flat spots 217
- Grading 211
- Markings 209, 210
- Pressure label 212
- Pressure monitoring 221

- Tires (continued)
  - Pressures 215, 220
  - Quality 211
  - Replacement of 217
  - Rotation 215
  - Run-Flat 218
  - Specifications 231
  - Summer 199
  - Wear 214
  - Wheel alignment 215
  - Winter 199
- TPMS 221
- Traction control 96
- Traffic Drive-Off Alert 120
- Traffic Sign Recognition 119
- Trailer towing 223
- Trip information 67
- Trunk 31
  - Interior emergency release 32

- Windows (continued)
  - Sunshades 27
- Winter Tires 218

## U

- Uniform tire quality grading 211
- Unlocking your vehicle 18
- User Profile
  - Creating 139
  - Loading preferences 141
  - Managing 141
  - Settings 141
  - Types 139
- Using 18

## V

- Vehicle
  - Accessories and modifications 206
  - Certification label 12
  - Modifications 5
- Vehicle Identification Number (VIN) 12
- Vehicle loading 223
  - Determining correct load limit 223
  - Example load calculations 224
- Vehicle Weight 228

## W

- Washers
  - Checking fluid level 195
  - Cleaning washer jets 197
- Wheels
  - Replacement 217
  - Specifications 231
- Wi-Fi 164
- Window lock 26
- Windows
  - Cleaning 203
  - Opening and closing 26

*Sapphire*

LUCID

Ver. 25 - en-US