

LUCID

---

# Owner's Manual - Lucid Air (NA)

 **WARNING**

Operating, servicing, and maintaining a passenger vehicle can expose you to chemicals, including phthalates, which are known to the State of California to cause cancer and birth defects, or other reproductive harm. To minimize exposure, wear gloves or wash your hands frequently when servicing your vehicle.

For more information, go to  
[www.P65Warnings.ca.gov/passenger-vehicle](http://www.P65Warnings.ca.gov/passenger-vehicle).

# Table of Contents

Chapters	Sections	
<b>Introduction</b>	<b>A Message From Lucid</b>	<b>2</b>
	A Message From Lucid	2
	<b>About This Manual</b>	<b>3</b>
	Using This Manual, Locating and Referencing Information	3
	Document Applicability	3
	Illustrations	3
	Revisions and Modifications	3
	Symbols Glossary for Important Information	3
	Trademarks	3
	Copyright	3
	<b>Information About This Vehicle</b>	<b>4</b>
	Quality Control	4
	Vehicle Modifications	4
	Body Repairs	4
	Electric Vehicle Precautions	4
	Personal Information and Data Sharing	4
	Data Sharing Permissions	5
<b>Vehicle Overview</b>	<b>Exterior</b>	<b>7</b>
	Exterior Overview	7
	<b>Interior</b>	<b>8</b>
	Interior Overview	8
	Vehicle Identification	10
	Steering Wheel Controls	11
	Glass Cockpit	12
	Pilot Panel	13
	Smart Drawer	13
	Rear Center Console Display (RCCD)	14
	<b>Opening and Closing</b>	<b>Keyless Entry System</b>
Using the Mobile Key		16
Using the Key Fob		16
Using the Valet Card		17
Replacing the Key Fob Battery		18
PIN to Drive		19
Caring for the Key Fob		19
Replacement Key Fobs		19

Type Approval	19
<b>Doors</b>	<b>20</b>
Opening Doors from the Outside	20
Opening Doors from the Inside	20
Door Warnings	20
Locking and Unlocking from Inside the Vehicle	21
Child Safety Locks	21
Automatic Locking and Unlocking	21
Opening Interior Doors with No Power	21
<b>Windows</b>	<b>22</b>
Window Safety	22
Opening and Closing Windows	22
Sunshades	22
<b>Hood</b>	<b>24</b>
Hood Opening and Closing	24
Accessing the Front Cargo Area	25
Hood Interior Emergency Release	25
<b>Trunk</b>	<b>26</b>
Trunk Opening and Closing	26
Accessing the Rear Cargo Area	27
Trunk Interior Emergency Release	27
<b>Safety &amp; Security</b>	<b>28</b>
Tow & Break-In Alert	28

---

## Seating & Safety Restraints

<b>Front Seats</b>	<b>30</b>
Adjusting the Front Seats	30
Correct Seating Position	30
Massage Feature	31
Seat Heating and Ventilation	31
<b>Rear Seats</b>	<b>33</b>
Rear Seat Folding	33
Rear Seat Pass-through	33
Rear Seat Heaters	33
<b>Head Restraints</b>	<b>35</b>
Correct Head Restraint Position	35
Adjusting the Head Restraints	35
<b>Seat Belts</b>	<b>37</b>
Seat Belt Warnings	37
Wearing Seat Belts	37
Fastening the Seat Belt	38
Seat belt reminders	38

Using Seat Belts When Pregnant	39
Seat Belt Pre-tensioners	39
Testing Seat Belts	40
<b>Child Safety</b>	<b>41</b>
Guidelines for Seating Children	41
Choosing a Child Safety Seat	41
Seating Larger Children	42
Installing Child Safety Seats	42
Installing LATCH or ISOFIX Child Seats	43
Installing Seat Belt Retained Child Seats	44
Attaching Upper Tether Straps	44
Child Safety Seat Warnings	45
<b>Airbags</b>	<b>46</b>
Location of Airbags and Airbag Sensors	46
Airbag Safety Information	47
Airbag Safety Labels	47
How the Airbags Work	47
Types of Airbags	48
Obstruction of Airbags	49
Front Passenger Seat Occupant Classification System (OCS)	50
Effects of Airbag Inflation	53
Airbag SRS Warning Indicator	53
Airbag Service Information	53

---

## Driving & Operating

<b>Driver Information</b>	<b>55</b>
Vehicle Information and Alerts	55
Trip Information	55
<b>Pilot Panel</b>	<b>56</b>
Extending and Retracting the Pilot Panel	56
<b>Center Cockpit Panel</b>	<b>57</b>
Center Cockpit Panel - Overview	57
Warning Indicators	58
High-Voltage Drive System Failure	64
Charge and Power Meter	64
Battery State of Charge Indicator	64
<b>Starting and Powering Off</b>	<b>65</b>
Starting	65
Powering Off	65
<b>Steering Wheel</b>	<b>66</b>
Adjusting the Steering Wheel Position	66
Steering Feel and Sensitivity	66
Steering Wheel - Right Controls	67
Steering Wheel - Left Controls	68

Horn	68
<b>Drive Selector</b>	<b>69</b>
Using the Drive Selector	69
Vehicle Creep	69
<b>Drive Modes</b>	<b>70</b>
Using Neutral	70
Drive Modes	70
Limited Power Mode	70
<b>Mirrors</b>	<b>72</b>
Adjusting the Exterior Side Mirror Position	72
Interior Rear View Mirror	72
<b>Exterior Lights</b>	<b>73</b>
Exterior Lights Control	73
High Beam Headlights	73
Rear Fog Light	74
Turn Signals	74
Hazard Warning Lights	75
<b>Interior Lights</b>	<b>76</b>
Interior Lights	76
Ambient Lighting	76
<b>Wipers and Washers</b>	<b>77</b>
Wipers	77
Washers	77
<b>Brakes</b>	<b>78</b>
Braking Systems	78
Anti-Lock Braking System (ABS)	78
Regenerative Braking	79
Vehicle Hold	80
Parking Brake	80
Brake Pad Wear	81
<b>Lucid Stability Control</b>	<b>82</b>
Lucid Stability Control	82
<b>Getting Maximum Range</b>	<b>83</b>
Driving Tips to Maximize Range	83
<b>Heating, Ventilation Air Conditioning</b>	<b>84</b>
Temperature Control	84
Defrost	85
<b>Interior Equipment</b>	<b>86</b>
Sun Visors	86
Glove Box	86

Front Armrest and Storage Compartment	87
Center Console Storage Compartment	87
Rear Armrest and Storage Compartment	87
Cup Holders	87
<b>Accessory Connections</b>	<b>89</b>
USB Connections	89
Wireless Charging	89
12 Volt Power Socket	90

---

## DreamDrive

<b>About ADAS</b>	<b>92</b>
ADAS Limitations	92
ADAS Features	93
ADAS Component Locations	94
<b>Driving Experience</b>	<b>96</b>
Steering Wheel DreamDrive Controls	96
DreamDrive Requirements	97
Adaptive Cruise Control	97
Highway Assist	99
Traffic Sign Recognition	101
Traffic Drive-Off Alert	102
Distracted Driver Alert	102
Drowsy Driver Alert	102
High Beam Assist	103
<b>Collision Detection and Protection</b>	<b>105</b>
Collision Protection	105
Automatic Emergency Braking	105
Forward Collision Warning	106
Rear Pedestrian Collision Protection	107
Cross Traffic Protection	107
Lane Departure Protection	108
Blind Spot Warning	109
Blind Spot Display	109
<b>Parking Experience</b>	<b>111</b>
Automatic Park In	111
Automatic Park Out	112
Surround View Monitoring	114
Rear View Monitoring	115
Park Distance Warning	115

---

## Infotainment

<b>User Profiles</b>	<b>118</b>
About User Profiles	118
Creating a User Profile	118
Profile Settings	119
Loading and Switching Profile Preferences	120

Removing Secondary User Profiles	120
Factory Reset	120
Changing Display Settings	121
<b>Media and Audio</b>	<b>122</b>
Media Overview	122
Physical Media Controls	123
Searching Media Content	125
AM and FM Radio	125
Logging into Media Applications	126
Playing Media from Devices	126
Audio Settings	127
<b>Using Alexa</b>	<b>128</b>
Alexa Built-In	128
<b>Maps and Navigation</b>	<b>129</b>
Navigation Overview	129
Navigation Settings	129
Navigating	130
Adjusting the Map	131
Predicting Energy Usage	132
Setting Home and Work Destinations	132
Map Updates and Offline Mode	133
<b>Phone and Smart Devices</b>	<b>134</b>
Bluetooth® Wireless Technology	134
Pairing a Bluetooth Device	134
Syncing Contacts and Messages	134
Connecting and Disconnecting Bluetooth Enabled Devices	134
Editing Bluetooth Enabled Device Preferences	135
Using the Phone App	135
Making and Receiving Phone Calls	135
In-Call Options	136
Using Messages	136
<b>Connecting the Vehicle to Wi-Fi®</b>	<b>137</b>
Add a New Wi-Fi Network	137
<b>HomeLink</b>	<b>138</b>
What is HomeLink?	138
HomeLink FCC/ISED Advisory	138
Programming HomeLink	138
Using HomeLink®	139
Renaming or Deleting a Program	140
<b>Vehicle Information</b>	<b>141</b>
Vehicle Identification Number	141
Direct Access to the Owner's Manual	141



Alerts and Notifications	141
<b>Software Updates</b>	<b>142</b>
Updating Software	142
Viewing Release Notes	143

---

## High-Voltage Battery Pack & Charging

<b>Electric Vehicle Components</b>	<b>145</b>
High-Voltage Components	145
<b>Battery Information</b>	<b>147</b>
About the Vehicle Batteries	147
High Voltage Battery Pack Care	147
<b>Charging Instructions</b>	<b>148</b>
Safety Checklist	148
Charge Port Door	148
Charging the Vehicle	149
Disconnecting the Charging Cable	149
Charging Status	150
Setting a Charge Limit	150
Cold Weather Charging Considerations	151

---

## Maintenance

<b>Maintenance Requirements</b>	<b>153</b>
Your Responsibility	153
Scheduled Maintenance	153
Fluid Replacement	153
Owner Maintenance	153
Electrical and High Voltage Safety	154
Maintenance Schedule	155
Multi-Point Inspection	156
<b>Fluid Reservoirs</b>	<b>157</b>
Checking Brake Fluid	157
Checking Windshield Washer Fluid	158
<b>Wiper Blades and Washer Jets</b>	<b>159</b>
Checking the Wiper Blades	159
Replacing Wiper Blades	159
Cleaning Washer Jets	159
<b>Cabin Air Filter</b>	<b>161</b>
Replacing the Cabin Air Filters	161
<b>Vehicle Care</b>	<b>162</b>
Cleaning the Exterior	162
Polishing, Paint, and Body Repairs	163
Using a Car Cover	164
Cleaning the Interior	164

Floor Mats	166
<b>Parts and Accessories</b>	<b>167</b>
Parts, Accessories, and Modifications	167
Body Repairs	167
<b>Vehicle Lifting Points</b>	<b>168</b>
Lifting the Vehicle	168

---

## Tire & Wheels

<b>Tire Information</b>	<b>170</b>
Understanding Tire Markings	170
International Tire Approval Marks	173
Uniform Tire Quality Grading	173
Tire and Loading Information Label	174
<b>Tire Care and Maintenance</b>	<b>176</b>
Inspecting and Maintaining Tires	176
Maintaining Tire Pressures	177
Replacing Tires and Wheels	179
Seasonal Tire Types	179
Driving in Low Temperatures	180
Tire Traction Devices	180
<b>Tire Pressure Monitoring System</b>	<b>181</b>
Tire Pressure Monitoring System (TPMS)	181
<b>Vehicle Loading</b>	<b>183</b>
Loading the Vehicle	183
Steps for Determining Correct Load Limit	183

---

## Technical Data

<b>Vehicle Dimensions and Weights</b>	<b>186</b>
Exterior Dimensions	186
Vehicle Weights	187
<b>Wheels and Tires</b>	<b>188</b>
Wheel and Tire Specifications	188
Tire Pressures	189
<b>Vehicle Sub-Systems</b>	<b>190</b>
Steering	190
Brakes	191
Front Suspension	192
Rear Suspension	193
Motors	194
Transmission	194
12V Batteries	194
High-Voltage Battery	194

---

## Roadside Assistance & Emergency Information

<b>Roadside Assistance</b>	<b>196</b>
Contacting Roadside Assistance	196
<b>Instructions for Transporters</b>	<b>197</b>
Transporting the Vehicle	197
Preparing the Vehicle for Transportation	197
Pulling the Vehicle onto a Trailer or Transporter	198
Securing the Vehicle for Transportation	198
Opening Hood without 12V Power	199
<b>Disabling the Power System</b>	<b>200</b>
Safety Precautions	200
Emergency Responder Cut Loop	200
<b>Vehicle Fire</b>	<b>201</b>
Firefighting	201

---

## Consumer Information

<b>New Vehicle Limited Warranty</b>	<b>203</b>
Message to Customers	203
Who is the Warrantor?	203
Who May Use This Limited Warranty?	203
What Does This Limited Warranty Cover?	203
New Vehicle Limited Warranty	204
Powertrain Limited Warranty	204
Battery Limited Warranty	204
Corrosion Perforation Limited Warranty	205
Supplemental Restraint System (SRS) Limited Warranty	205
What Does This Limited Warranty Not Cover?	205
What Will Cause the Warranty to Be Voided?	207
What to do if you need Roadside Assistance?	207
What is the Coverage Period?	207
What Are Your Remedies?	208
Limitations on Liability	208
Dispute Resolution	209
<b>Customer Care</b>	<b>211</b>
Contacting Lucid Motors	211
<b>Reporting Safety Defects</b>	<b>212</b>
United States	212
Canada	212
<b>Disclaimers</b>	<b>213</b>
California Proposition 65	213
California Perchlorate Advisory	213
Vehicle Telematics	213
Data Recording	213

<b>Vehicle Recycling</b>	<b>215</b>
High-Voltage Battery Recycling Process	215
<b>FCC, FDA, and ISED Compliance</b>	<b>216</b>
FCC and ISED Certification	216



01

# Introduction

---

# A Message From Lucid

A Message From Lucid

---

Thanks for choosing Lucid. We're honored to have you aboard.

Lucid Air was designed and engineered with a devout dedication to detail, every aspect carefully considered. We hope you cherish this vehicle as much as we did in developing it.

This Manual helps you get acquainted with your Lucid Air, and includes important information on how to operate, maintain, and get the most out of your ownership experience.

Congratulations on your purchase, and welcome to luxury electric.

# About This Manual

## Using This Manual, Locating and Referencing Information

This Owner's Manual contains information to help you configure, maintain, and enjoy your Lucid Air. We advise you to take some time to familiarize yourself with it before driving.

Failure to follow the manual's instructions and warnings can result in vehicle damage, severe personal injury or death to you and others, and voiding the New Vehicle Limited Warranty.

To quickly find a topic, please refer to the index.

*Note:* References to the vehicle's left or right side assume you are seated in the car facing forward.

## Document Applicability

This Manual applies to all Lucid Air vehicles.

Lucid regularly updates this manual. The latest version is accessible via the Pilot Panel and on the Lucid website. Internet connection is required to download the most recent version of the manual.

## Illustrations

The Owner's Manual provides illustrations to locate components or features described in the accompanying text. Depending on vehicle specification, software version, region of purchase, and specific settings, your vehicle may appear slightly different. However, the essential information in the illustrations is correct.

## Revisions and Modifications

Continuous improvement is a goal at Lucid, and we reserve the right to make changes at any time, without notice and obligation.

## Symbols Glossary for Important Information

The Owner's Manual uses the following symbols for important information:

- **WARNING:** Indicates a hazard which, if not avoided, or instruction which,

if not followed, could result in severe injury or death.

- **CAUTION:** Indicates a hazard which, if not avoided, or instruction which, if not followed, could result in damage to your vehicle.

*Environmental:* Indicates an instruction to observe to avoid unnecessary damage to the environment.

## Trademarks

Lucid, the Lucid logo, Air, the Air logo, Dream Edition, DreamDrive, Wunderbox, Surreal Sound, and Pure Spec logo are trademarks of Lucid USA Inc, its subsidiaries, and/or its affiliates.

The Bluetooth(R) word mark and logos are registered trademarks owned by Bluetooth SIG, Inc. and any use of such marks by Lucid is under license.

All other trademarks contained in this document are the property of their respective owners, and their use herein does not imply sponsorship or endorsement of their products or services. The unauthorized use of any trademark displayed in this document or on the vehicle is strictly prohibited.

## Copyright

©2022 Lucid USA, Inc. All rights reserved. The information presented is current at the time of publication and subject to copyright and intellectual property rights of Lucid USA, Inc. and its subsidiaries and/or affiliates. This document may not be reproduced, archived, or transmitted in any form or by any means, nor modified or replicated to other sites, without the prior written permission of Lucid USA, Inc.



---

# Information About This Vehicle

## Quality Control

---

You may notice miles/kilometers on the odometer when you take delivery of your vehicle. The mileage is a result of the comprehensive process used to ensure the quality of your car.

Our quality control process includes extensive inspections during and after production. The final inspection takes place at the delivery center and consists of a road test conducted by a trained **Lucid** technician.

## Vehicle Modifications

---

- **WARNING:** Lucid does not recommend installing non-approved parts and accessories or performing non-approved vehicle modifications. Doing so can negatively affect your vehicle's performance and the safety of its occupants. Non-approved modifications may lead to invalidation of your warranty.
- **WARNING:** Lucid is not responsible for death, injury, or damage that occurs as the result of using or installing non-approved parts or accessories, or making non-approved modifications.

**Note:** If you have a disability that requires modifying the vehicle, contact **Lucid** before making any modifications.

## Body Repairs

---

If you damage the vehicle in a collision, make sure a **Lucid-approved Service Center** repairs your car using only genuine **Lucid** parts. Contact **Lucid Customer Service** - 1-888-LUCID.

For more information, see [Body Repairs](#) on page 167.

## Electric Vehicle Precautions

---

- **WARNING:** Your Lucid Air is a 100% electric vehicle, utilizing high-voltage AC and DC systems as well as a 12-volt system. The AC and DC high-

voltage systems can cause personal injury, severe burns, electric shock, and even death unless you take appropriate precautions.



You will find the above label affixed to several high-voltage components found on your vehicle to alert you to any possible risks. Always observe and obey the instructions on labels attached to components on the car; they are there for your safety.

- **WARNING:** Do not touch or attempt to remove or replace any high-voltage (HV) parts, wiring, or connectors. The orange outer sleeving identifies the high-voltage wiring and connectors.
- **WARNING:** If the vehicle is involved in an accident, do not touch any high-voltage wiring or the components connected to the wiring.
- **WARNING:** Should a vehicle fire occur, immediately evacuate the vehicle and contact your local fire emergency responders, as they possess the proper training and equipment to extinguish electric vehicle fires safely.
- **WARNING:** The vehicle contains a sealed Li-ion high-voltage battery. Improperly disposing of the Li-ion can risk personal injury, severe burns, electrical shock, death, and environmental damage.

## Personal Information and Data Sharing

---

For information on how Lucid uses and protects your personal information, visit our website at [www.lucidmotors.com/legal](http://www.lucidmotors.com/legal)

---

## Data Sharing Permissions

---

You can disable data sharing from the Pilot Panel by touching Settings > Connectivity > Data Sharing Permissions. From here you can toggle data sharing settings.

Please note that disabling data sharing also disables the following features:

- Signing in and out of your user profile
- Saving and restoring user profiles and preferences to the cloud
- Resetting user PINs
- Mobile app interactions

*Note:* When data sharing with Lucid is disabled, third-party apps still receive and transmit data as needed by those third-party terms of use. Lucid may also still receive data and personal information regarding you and your vehicle from third parties.

02

# Vehicle Overview

# Exterior

## Exterior Overview

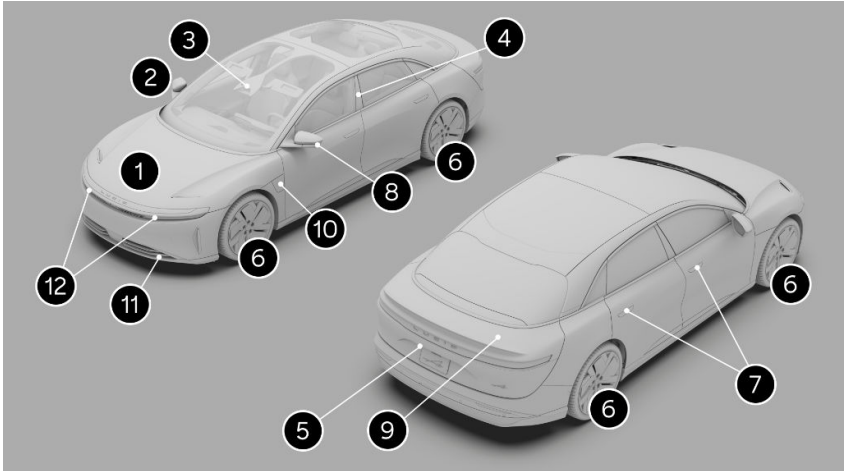

1. Hood, see [Hood Opening and Closing](#) on page 24
2. Exterior side mirror, see [Adjusting the Exterior Side Mirror Position](#) on page 72
3. Front multifunction camera
4. Pillar camera
5. Rear view camera, see [Rear View Monitoring](#) on page 115
6. Tires and wheels, see [Inspecting and Maintaining Tires](#) on page 176
7. Exterior door handle, see [Opening Doors from the Outside](#) on page 20
8. Surround View Monitoring cameras, see [Blind Spot Display](#) on page 109
9. Trunk, see [Trunk Opening and Closing](#) on page 26
10. Charge port door, see [Charge Port Door](#) on page 148
11. Recovery eye attachment point, see [Pulling the Vehicle onto a Trailer or Transporter](#) on page 198
12. Headlights

Note: For detailed camera locations, see [ADAS Component Locations](#) on page 94.

# Interior

## Interior Overview

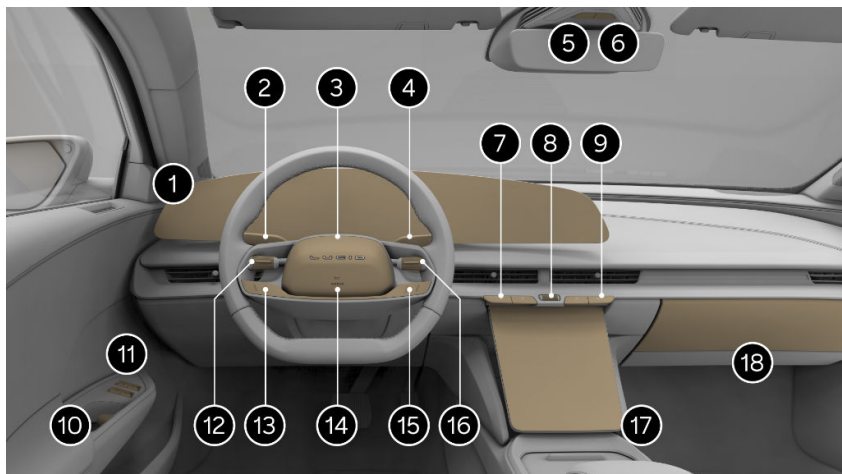

1. Glass Cockpit, see [Glass Cockpit](#) on page 12
2. Left control stalk:
  - Washers, see [Washers](#) on page 77
  - Turn Signals, see [Turn Signals](#) on page 74
  - High Beams, see [High Beam Headlights](#) on page 73
3. Driver camera (behind the steering wheel)
4. Gear and parking brake selector, see [Using the Drive Selector](#) on page 69
5. Hazard warning lights button, see [Hazard Warning Lights](#) on page 75
6. Interior light, see [Interior Lights](#) on page 76
7. Driver temperature controls, see [Temperature Control](#) on page 84
8. Volume control, see [Physical Media Controls](#) on page 123
9. Passenger temperature controls, see [Temperature Control](#) on page 84
10. Interior door handle, see [Opening Doors from the Inside](#) on page 20
11. Window switches, see [Opening and Closing Windows](#) on page 22
12. Left toggle switch



13. DreamDrive controls
14. Horn, see [Horn](#) on page 68
15. Media controls, see [Steering Wheel - Right Controls](#) on page 67
16. Right toggle switch, see [Steering Wheel - Right Controls](#) on page 67
17. Pilot panel, see [Pilot Panel](#) on page 56
18. Glove box

## Vehicle Identification Number

You may be asked to provide the Vehicle Identification Number (VIN) when communicating with **Lucid Motors**. You can find the VIN in the following locations:

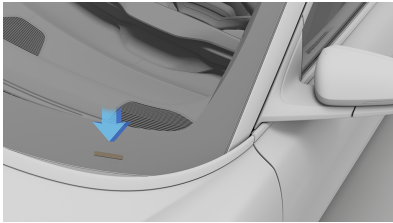
- Top of dashboard - the VIN is visible through the lowest part of the left-hand side of the windshield.



- On the Pilot Panel, select  >  About Vehicle to view the VIN.
- On the floor, under the front passenger's seat. Lift the cutout on the floor carpet to gain access the VIN.

*Note:* The VIN is also shown on the vehicle certification label and tire information label.

## Vehicle Certification Label

The vehicle certification label is located on the left A-pillar.

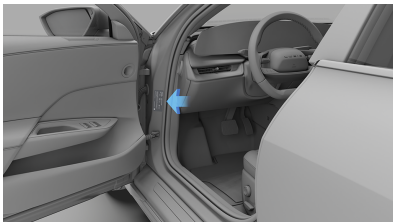

The vehicle certification label states the following important information:



- Manufacturer of the vehicle
- Date the vehicle was manufactured (MM/YY)
- Gross Vehicle Weight Rating (GVWR)  
*Note:* GVWR is the maximum allowable weight of the fully loaded vehicle. This includes all options, equipment, passengers, and cargo.
- Gross Axle Weight Rating (GAWR)  
*Note:* GAWR is the maximum allowable weight that a single axle (front or rear) can carry.
- Vehicle Identification Number (VIN)
- **WARNING:** Do not exceed the GVWR or the GAWR specified on the vehicle certification label.
- **WARNING:** Exceeding the certification label vehicle weight limits can adversely affect the performance and handling of your vehicle. Overloading may also cause permanent damage to components, which could result in a loss of control of your vehicle, serious personal injury, or death.
- **WARNING:** Do not use replacement tires with lower load-carrying capacities than the original tires, because they may lower your vehicle's GVWR and GAWR limitations. Replacement tires with a higher limit than the original tires do not increase the GVWR and GAWR limitations.



1. Left toggle switch
2. DreamDrive button
3. Following distance button
4. Cancel button
5. Right toggle switch, see [Steering Wheel Media Controls](#)
6. Previous button, see [Steering Wheel Media Controls](#)
7. Next button, see [Steering Wheel Media Controls](#)
8. Voice Assistant button, see [Steering Wheel Media Controls](#)



The 34-inch (86 cm) Glass Cockpit is ergonomically contoured to the driver, giving you easy access to controls without being distracted.



1. Left Cockpit Panel: The functions on this touchscreen are available at all times:
  - Charge port door control, see [Charge Port Door](#) on page 148
  - Door locks, see [Opening Doors from the Inside](#) on page 20
  - Front and rear windshield defrost, see [Defrost](#) on page 85
  - Exterior lighting controls
  - Wiper controls, see [Wipers](#) on page 77
  - Frunk controls, see [Hood Opening and Closing](#) on page 24
2. Center Cockpit Panel: This panel displays the centralized Cockpit Panel, with system messages and information displayed to the left and right. Any warning indicators appear here.
3. Right Cockpit Panel: This touchscreen gives you access to the following:
  - Media and audio, see [Media and Audio](#) on page 122
  - Maps and navigation, see [Maps and Navigation](#) on page 129
  - Communication, see [Phone and Smart Devices](#) on page 134
  - User Profiles, see [User Profiles](#) on page 118
  - HomeLink® controls, see [HomeLink](#) on page 138
  - Bluetooth® controls, see [Connecting and Disconnecting Bluetooth Enabled Devices](#) on page 134
  - Wi-Fi® controls, see [Add a New Wi-Fi Network](#) on page 137

Pilot Panel

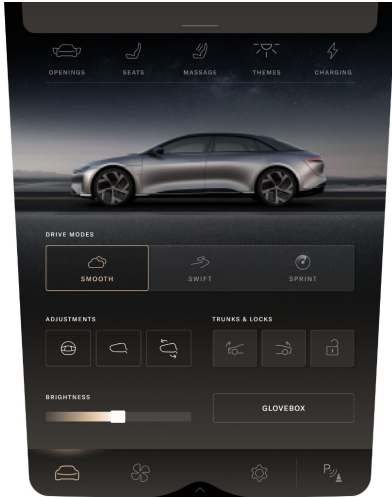

The icons along the bottom of the Pilot Panel touchscreen allow you to access:

- Vehicle controls
- Climate controls, see [Temperature Control](#) on page 84
- Settings menu
- Parking controls, see [Parking Experience](#) on page 111

*Note:* In some menus on the Pilot Panel, you can press the icons for list view or tile view to toggle between display options.

*Note:* The Pilot Panel can be retracted to access the storage space behind it. See [Extending and Retracting the Pilot Panel](#) on page 56.

Smart Drawer

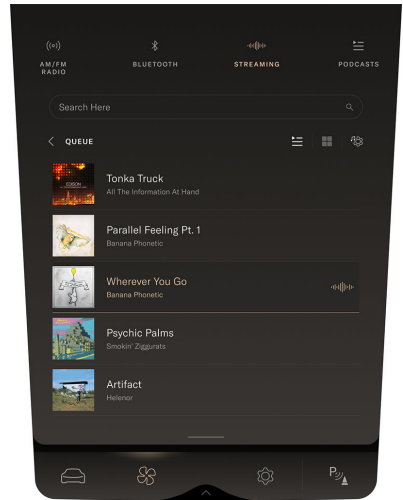
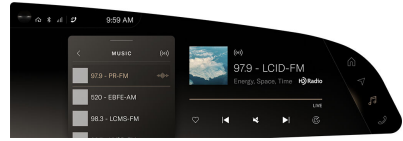

Some applications display in the smart drawer window on the right Cockpit Panel, allowing you to browse the contents. The Pilot Panel view of the smart drawer shows additional details for lists and libraries.

- **WARNING:** This content is intended to minimize driver distraction to facilitate safe driver behavior. It is recommended that the driver maintains vision of the road at all times during normal driving maneuvers. Distracted driving can lead to serious injury or death.

To open the smart drawer in the Pilot Panel, press the bar at the top of the touchscreen; in the right Cockpit Panel, press the bar at the bottom of the touchscreen. Swipe the smart drawer up or down to slide it between screens. If the smart drawer collapses due to timeout on either screen, touch the bar to expand it again.

---

The < arrow in the upper left corner of a menu title returns you to the previous screen.



#### Rear Center Console Display (RCCD)

---

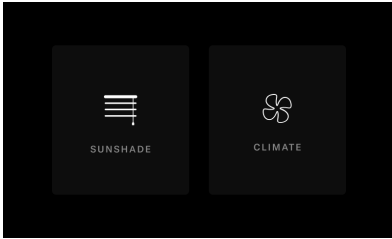
The Rear Center Console Display (RCCD) is located at the back of the center console and allows rear seat passengers to control the climate and the sunshade settings.



The RCCD provides the following options for rear seat passengers:

-  Sunshade - Deploys and retracts the Rear Sunshade, see [Sunshades](#) on page 22.
-  Climate - Controls for temperature, fan speed, and seat heating in the rear seats, see [Rear Seat Heaters](#) on page 33.

*Note:* You can lock access to the Rear Center Console Display (RCCD) by navigating to Settings > Pilot Displays on the Pilot Panel.

03

# Opening and Closing

---

# Keyless Entry System

## Using the Mobile Key

---

Mobile Key allows you to use your phone to unlock, lock, and gain drive access to the vehicle using the Lucid Mobile app. In order to use the Mobile Key, you must first pair it with the vehicle.

### Pairing

You must pair the mobile device in order to access the Mobile Key functions.

1. On the Pilot Panel:
  - a. Go to Settings > Access & Profiles > Profile Detection > Keys.
  - b. Make sure that Key Detection is enabled.
  - c. Press Link Mobile Key.
2. On your mobile device:
  - a. Open the Lucid Mobile app.
  - b. Press the Mobile Key icon in the top right-hand corner of the home screen.
  - c. Press Link Now.
  - d. Wait for the 6-digit passcode.
3. Confirm the 6-digit passcode on the Pilot Panel matches the mobile device code.
4. Type a name for the mobile device on the Pilot Panel, and press Done.

### Unpairing

You can unpair mobile devices either from within the Settings in the vehicle or from the mobile device. Once unpaired, you will not be able to use the mobile device for Mobile Key functions.

Unpairing from the Settings app

1. Go to Settings > Access & Profiles > Profile Detection > Keys.

2. Press Edit.
3. Press Remove next to the mobile device to be unpaired.

Unpairing from the Lucid Mobile app

1. Press the Mobile Key icon in the top right-hand corner of the home screen.
2. Press Remove Vehicle.
3. Go to your device's Bluetooth Settings, navigate to the list of Bluetooth devices and tap Forget for the vehicle. Select Forget or Unpair depending on the OS to unpair your Android device. To unpair the iOS device, tap  and Forget this device. You can refer to the Lucid Mobile app for additional information on the Troubleshooting modal.

### Vehicle Controls

Mobile Key controls (unlock, lock, and drive access) function the same way as the passive features for the key fob.

## Using the Key Fob

---

Your vehicle includes two alternate keyless entry systems: a key fob and a valet card.

- **WARNING:** The keyless entry system uses low-frequency radio transmissions that might interfere with implanted medical devices. To avoid any possibility of interference, keep such medical devices away from any transmitters.
- **WARNING:** To prevent other occupants' accidental operation of the vehicle's systems, do not leave a key fob in an unattended vehicle.
- **CAUTION:** To ensure your vehicle is left in a secure state, remove all key fobs from the car before leaving it unattended.

**Key fob range**

The key fob communicates with receivers in the vehicle via Bluetooth® Low Energy (LE) and low-frequency radio communication. While it is not necessary to point your key fob at the car, it must be within operating range to work.

*Note:* The key fob operating range varies, depending upon environmental factors. Nearby radio transmitters (e.g., amateur or CB radios, radio or television stations, airports) may interfere with communications between the key fob and the vehicle. In cases of interference, it may be necessary to move closer to the car than usual to operate the key fob.

You can operate the key fob manually once it is detected or is closer to the vehicle.

While carrying a key fob, all doors will automatically unlock and present their handles when approaching your vehicle.

When leaving your vehicle while carrying a key fob, all doors will automatically lock, and any presented door handles will retract.

**Key fob operation**

As you approach the vehicle, the key fob should be within range.

*Note:* The key fob button is located on the center of the top surface, in the middle of the LUCID logo.



Once within range, the key fob operates as follows:

- Press once to lock all doors, trunk, and front trunk.

- Press twice to unlock all doors, trunk, and front trunk.
- Press and hold the button to open or close the front trunk.
- Press the button four times for the panic alarm to trigger. To cancel the panic alarm, press the button four times again or twice to unlock it.

**Key fob troubleshooting**

If the key fob does not respond when pressed:

- Try operating the key fob as closely to your vehicle as possible. Other radio equipment operating on a similar frequency may interfere with the signals from your key fob.
- The key fob battery may need replacing. See [Replacing the Key Fob Battery](#). If the key fob battery is depleted, you can still unlock the vehicle by holding it near the driver's side center pillar (similar to the valet card).

If you cannot unlock your vehicle with the key fob, use the mobile app or Valet Card. See [Using the Valet Card](#). Contact Lucid Customer Care if the problem persists.

*Using the Valet Card*

Use the Lucid Valet Card within close range of the vehicle only and as a backup method for vehicle entry. You might use or lend the Valet card when:

- Using a valet parking service
- Leaving your vehicle to be serviced or repaired at a Lucid Service Center
- Experiencing key fob issues (e.g., misplaced or low battery)

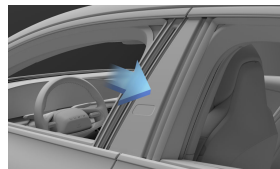

Hold the Valet card just above the driver's side center pillar camera to lock or unlock the doors.

*Note:* To drive the vehicle using only the valet card, you must enter the pin associated with the current user profile when shifting out of Park.

#### Replacing the Key Fob Battery

- **WARNING:** The key fobs supplied with your vehicle contain a coin/button-type battery. These batteries contain toxic and corrosive substances. Batteries are a chemical burn hazard and should never be ingested. Batteries, if swallowed, can cause severe internal burns and may even lead to death.
  - Keep new and used batteries out of the reach of children.
  - If you think batteries may have been swallowed, seek immediate medical attention.
- **WARNING:** If the cover for the key fob will not close securely, stop using the key fob and keep it out of the reach of children. Contact a Lucid Service Center for a replacement key fob.
- **WARNING:** There is a risk of explosion if an incorrect battery is installed. Only install a battery that is identical to the battery specified in this manual.

The key fob battery is type CR2032 and will need occasional replacement. The vehicle alerts you with a 'Key fob Battery Low' message on the Cockpit Panel.

*Note:* Replace a low key fob battery as soon as possible to avoid complications with the vehicle systems.

To replace the key fob battery:

1. Remove the battery cover.

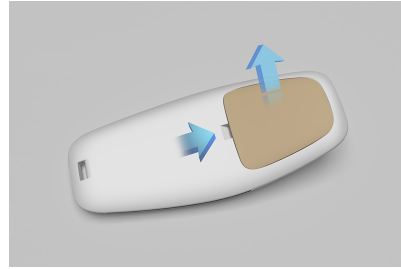

2. Remove the old battery.

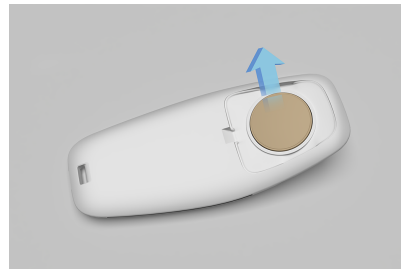

3. Avoid touching the flat surfaces of the new battery if possible, as fingermarks can reduce battery life.
4. Wipe the battery clean before installation.
5. Fit the battery with the "+" side facing upwards.
6. Replace the battery cover.

*Environmental:* Used batteries must be disposed of correctly, as they contain harmful substances. Please refer to local regulations.

#### Dead key fob battery

Even when the key fob battery has died, it is possible to access the car. Press the door handle to lock or unlock the car, then hold the key fob against the driver's side center pillar under the camera area to perform a lock/unlock action.

PIN to Drive

---

When accessing the vehicle with a dead key fob or valet card, drivers will need their to enable driving. After pressing the brake pedal, drivers enter the PIN using the Pilot Panel. After entering a valid PIN, drivers can operate the vehicle until the driver's door opens again, resetting authentication.

*Note:* After 21 unsuccessful attempts, the driver cannot enter the PIN again for 2 hours.

Caring for the Key Fob

---

- **CAUTION:** To protect the electronic circuitry inside, do not expose the key fob to:
  - Impacts
  - Liquids
  - High temperatures (including prolonged sunlight exposure)
  - Waxes, solvents, or abrasive cleaners

Replacement Key Fobs

---

If you lose a key fob, contact a **Lucid Service Center** to obtain a replacement.

If ordering a new key fob, you must bring all available key fobs and Valet cards for the vehicle to the **Lucid Service Center** to reprogram the system.

Type Approval

---

**United States**

This device complies with Part 15 of the FCC Rules.

Operation is subject to the following two conditions:

1. This device may not cause harmful interference, and
2. This device must accept any interference received, including interference that may cause undesired operation.

This equipment complies with FCC radiation exposure limits set forth for an uncontrolled environment. End-users must follow the specific operating instructions for satisfying RF exposure compliance. This transmitter must not be co-located or operating in conjunction with any other antenna or transmitter.

Changes or modifications not expressly approved by the party responsible for compliance could void the user's authority to operate the equipment.

**Canada**

This device complies with Industry Canada's license-exempt RSS standards. Operation is subject to the following two conditions:

1. This device may not cause interference, and
2. This device must accept any interference, including interference that may cause undesired operation of the device.



---

# Doors

## Opening Doors from the Outside

---

### Opening doors

The door handles will extend when:

- A valid key fob is detected next to the vehicle.
- A valid key fob or valet card is detected next to the vehicle on the left driver's side center pillar, and the door handle is pressed.
- The key fob is pressed twice to unlock the doors. See [Using the Key Fob](#).
- The mobile app is used to unlock the doors.

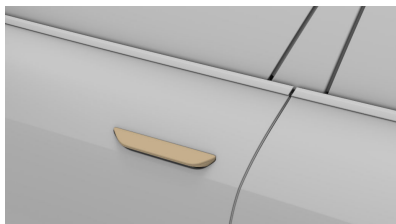

Once a handle extends, pull up on it to open that door.

*Note:* If a door handle is not opened within two minutes of presenting, it will retract. Other opening methods discussed in this section can be used to extend it again.

*Note:* If there is a collision, all exterior door handles will present if there is still available power and the door units are not damaged.

### Closing doors

The door handles retract when:

- The vehicle locks itself upon the user with the key fob(s) walking away from the vehicle.
- A valid key fob or valet card is detected within 2 inches (5 cm) of the sensor on

the left driver's side center pillar, and the door handle is pressed.

- The key fob is pressed once to lock the doors.
- The mobile app is used to lock all doors.

To close a door manually, push it until it is almost closed; you will feel the power cinch motor take over. The door will then close automatically.

## Opening Doors from the Inside

---

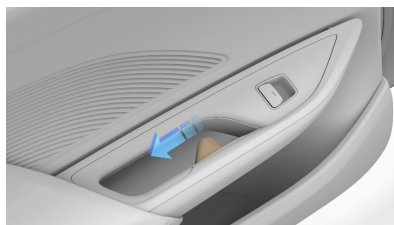

When the car is in Park, pull the release handle (highlighted) once to both unlock and open the door. Note that this electronic release mechanism is disabled when the vehicle is in motion.

In the event the door loses power, pull the release handle to full travel to open.

*Note:* To prevent children from using the interior handles to open the rear doors, see [Child Safety Locks](#). Rear doors will not open when child locks are engaged.

## Door Warnings

---









Whenever a door is open while the vehicle is in D (Drive) or R (Reverse), a warning icon appears on the Cockpit Panel, and open doors are displayed as shown.



Locking and Unlocking from Inside the Vehicle

The doors and trunk can be locked and unlocked from inside the vehicle using the touch screens on the left Cockpit Panel or the Pilot Panel. To lock or unlock all the doors:

- On the left Cockpit Panel, press the  lock/unlock icon.
- On the Pilot Panel, select  and press the  lock/unlock icon.
- On the Pilot Panel, select  >  OPENINGS and press the  lock/unlock icon.



When pressed, the  icon will change to a locked or unlocked symbol, indicating the current state of the door locks.

Child Safety Locks

Your vehicle has child safety locks on both rear doors. When active, this system prevents occupants from opening rear doors using the interior door handles.

- **WARNING:** Child safety locks should be activated whenever children are seated in the back seats for their safety. There is a risk of severe injury or death if a child operates the back doors.
- **WARNING:** Never leave children unsupervised in any car.

*Note:* Exterior door handles will still operate according to the vehicle's lock status.

To toggle child safety locks, use the Pilot Panel and touch  >  OPENINGS, and

then touch the CHILD LOCK button. The CHILD LOCK button illuminates when child safety locks are activated.

Automatic Locking and Unlocking

Once the vehicle starts moving, all doors automatically lock. The doors will remain locked when the vehicle is in Park. (You can choose to activate auto-unlock when shifting into Park under Settings.)

If the airbags deploy, all doors will automatically unlock but remain latched. See [Effects of Airbag Inflation](#).

Opening Interior Doors with No Power

If the vehicle loses power, you can open every door using the interior door handles.

To open from inside, pull the interior handle to the second detent for the manual door latch to release.

*Note:* Child safety locks will be unavailable in the event of a power loss, even if enabled before the vehicle lost power (see [Child Safety Locks](#)).

# Windows

## Window Safety

- **WARNING:** Although your car is equipped with obstacle detection on all four windows, children, other passengers, or objects can still be trapped by moving windows. Use caution when operating the windows.
  - Do not allow children to play with the window switches.
  - Never stick objects or body parts through an open window.
- **WARNING:** On hot days, the temperature in the vehicle interior can rise very quickly. Exposure to these high temperatures for even a short time can cause a heat-related injury or death. Small children and animals are particularly at risk and should never be left unattended in a vehicle.

## Opening and Closing Windows

The power windows operate only when the vehicle is powered on.

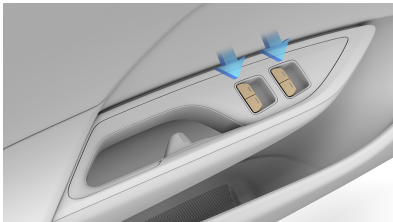

The driver's door window switches control all vehicle windows. Pull up or press down on a switch to raise or lower the associated window.

Each passenger door contains a window switch for its associated window.

- To automatically raise or lower a window fully, push or pull the switch past the resistance point and then release. Push or pull the switch again to stop.

- To partially raise or lower a window, gently push or pull the switch up to the resistance point. Release when the window is at the desired position.



*Note:* The windows will automatically stop closing and reverse if an obstruction is detected.

### Inhibiting rear window operation

- **WARNING:** Window locks should be activated for children's safety. There is a risk of severe injury or death if a child operates the rear windows while seated in the back seats.
- **WARNING:** Never leave children unsupervised in a vehicle.

You can operate the rear windows using the switches on the rear doors when the window lock is not activated.

The window lock feature in the left Cockpit Panel or the Pilot Panel prevents passengers from operating the rear window switches.

- To toggle this feature, touch  >  DOORS and press WINDOW LOCK on the Pilot Panel.
- Alternately, touch the  window lock icon on the Left Cockpit Panel.

The WINDOW LOCK button illuminates when active.

## Sunshades

Some Lucid Air models are equipped with power sunshades in the rear window and both rear passenger windows. Raising the power sunshades in sunny weather conditions can reduce glare and help regulate the internal vehicle temperature.

- **CAUTION:** To prevent damage to the child seat tether anchor point cover, it must be closed when lowering the rear sunshade.





### Side window sunshades

Window switches in the rear doors also operate the side window sunshades.

Raise a sunshade by continuing to hold the window UP button after the window is fully raised.

### Rear window sunshade

There are two way to operate the rear window sunshade:

- On the Rear Center Console Display home screen, select  SUNSHADE, and touch EXTEND or STOW.
- From the Pilot Panel, select  >  OPENINGS, and touch the  sunshade icon to raise or lower the sunshade.

# Hood

## Hood Opening and Closing



In the case of an unlatched hood, the red Door Open warning indicator appears on the Cockpit Panel. If this occurs, **Lucid** recommends you stop the vehicle in a safe location and place the vehicle in P (Park). Then check if the hood is correctly closed.









If the vehicle is in D (Drive) or R (Reverse) and the hood is unlatched, it will be highlighted red.

### Opening the hood

*Note:* All electrical unlatching of the hood is disabled when the vehicle is in motion.

To electronically open and close the hood:

- Use the Lucid mobile app.
- On the Pilot Panel, select  and press the  hood opening icon.
- On the Pilot Panel, select  >  DOORS and press the  hood opening icon.
- On the Left Pilot Panel, press the  hood opening icon.
- Press and hold the key fob within 6.5 feet (2 m) of the front trunk.

Once you have successfully unlatched the hood, you may raise it. The hood has two gas



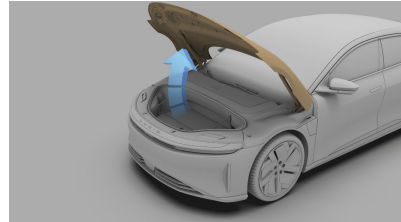

struts to aid in opening and to hold it in the open position.



*Note:* In frigid temperatures, you may find that the gas struts do not hold the hood open as firmly as they do in warmer temperatures.

### Closing the hood automatically

To close the hood using the power-assist system:

- Use the Lucid mobile app.
- Select  and press the  hood close icon on the Pilot Panel.
- Select  >  DOORS and press the  hood close icon on the Pilot Panel.
- Press and release the close button on the front edge of the frunk.

### Automatic movement stop

If anything obstructs the hood to prevent it from opening or closing, it will stop moving.

*Note:* The Cockpit Panel alerts you if the hood stops automatically.

If the hood stops due to an obstruction, remove it and try to open or close again. If it cannot be opened or closed a second time, try to operate the hood manually.

### Closing the hood manually

*Note:* Some models may come equipped with Power Opening and Closing Hood systems.

- **WARNING:** Always check the area around the hood for obstructions (such as people or objects) before closing the hood. Failure to do so could result in serious injury to a person or damage to the vehicle.
- **CAUTION:** Do not use excessive force when closing the hood, as the hood panel could be damaged.

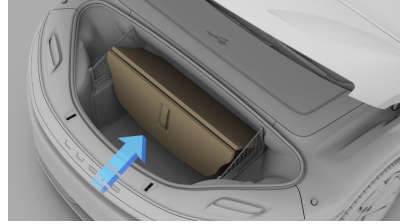

Hood Interior Emergency Release

To close the hood:

1. Gently lower until the hood is almost closed.
2. Place your hands on top of the hood at the points illustrated.
3. Gently press until you feel the power auto-cinch take over to pull it closed.

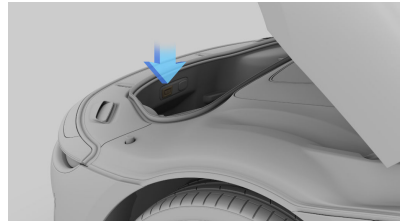
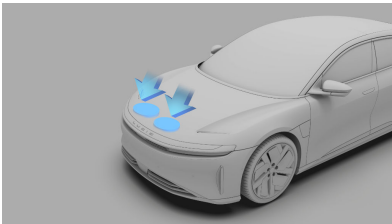

If a person becomes trapped inside the front trunk, open the hood from the inside by pressing the interior release button.

4. After closing, check that the latch is fully engaged by attempting to lift the front edge of the hood. The hood should be free from all movement.

- **WARNING:** If any part of the Hood hinge appears to be loose, contact your local service centre. If safe to do so, the vehicle can be driven to a Lucid service centre. If the vehicle is not safe to be driven, then you must have your vehicle transported to the service centre.

#### Accessing the Front Cargo Area

To access the lower cargo area in the front trunk, pull up on the cargo cover handle. The cargo cover is not attached to the vehicle, and can be folded back or removed if necessary.

# Trunk

## Trunk Opening and Closing

- **WARNING:** Be aware of the risk of serious injury when operating the trunk. Before opening or closing, ensure no one is in the path of the trunk's movement.
- **CAUTION:** Do not use excessive force when operating the trunk manually.





The vehicle must be in P (Park) to allow the trunk to operate.

If the trunk is not fully closed when shifting the car out of P (Park), the system illuminates the  Door Ajar warning indicator on the Cockpit Panel. If the car is in D (Drive) or R (Reverse) and the trunk is unlatched, it will be highlighted red.



### Opening the trunk

The trunk can be unlocked and opened by any of the following methods:



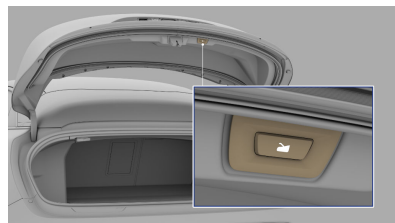

- Use the Lucid mobile app.
- Select , and press the  trunk release icon on the Pilot Panel.
- Select  >  DOORS, and press the  trunk release icon on the Pilot Panel.

- Use the manual handle on the trunk when doors are unlocked or if you have a key fob with you.

### Closing the trunk



To close the trunk:

- Use the Lucid mobile app.
- Select  and press the  trunk close icon on the Pilot Panel.
- Select  >  DOORS and press the  trunk close icon on the Pilot Panel.
- Press and release the close button on the lower edge of the deck lid.
- Manually pull the deck lid down until the power cinch engages.

### Automatic movement stop

If anything obstructs the deck lid with enough force to prevent it from opening or closing, it will stop moving.

*Note:* The Cockpit Panel alerts you if the decklid stops automatically.

If the decklid stops due to an obstruction, remove it and try to open or close again. If it cannot be opened or closed a second time, try to operate the trunk manually.

- **WARNING:** Exercise caution when opening or closing the hood and decklid in windy conditions. If a strong gust blows against the hood and decklid, it could close suddenly, resulting in injury.
- **WARNING:** Keep hands and fingers away from the area between the hood and door while closing. They may not be detected by sensors. It's good practice to keep your hands away from this area while opening or closing the hood.

2. Push upwards on the deck lid to open the trunk.

Accessing the Rear Cargo Area

To access the lower cargo area in the rear trunk, pull up on the cargo cover handle. The cargo cover is not attached to the vehicle, and can be folded back or removed if necessary.

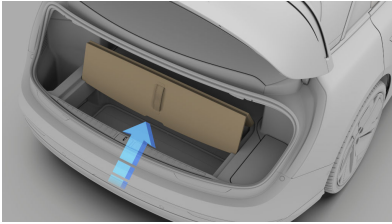

Trunk Interior Emergency Release

A mechanical release, located on the inside of the trunk, allows you to open the trunk if the vehicle has no electrical power.

**Note:** The mechanical release will allow a person trapped inside to get out.

1. Pull the handle firmly outward to release the trunk latch.

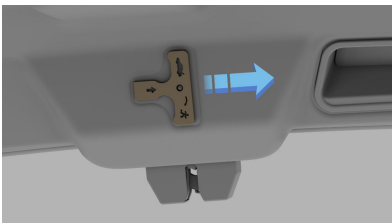



---

# Safety & Security

Safety & Security is a Settings menu item that controls most safety & security features. To access Safety & Security, tap the Settings icon on the Pilot Panel and tap Safety & Security.

---

## Tow & Break-In Alert

---

Vehicle sensors can detect significant impacts, intrusions, or unauthorized towing while your vehicle is in P (Park) and can trigger alarms and notifications.

To access Tow & Break-In Alert settings

from the Pilot Panel, select  >

 Safety and Security. Alternatively, use Settings from the Lucid Mobile App. You can then select a notification type (both an alarm and push notification or a push notification only) and disable the Tow & Break-In Alert.

By default, the Tow & Break-In Alert is ON unless manually disabled (for example, towing) and will notify you through the Alarm and Push Notification.

Disable the Tow & Break-In Alert for towing or servicing. If disabled, Tow & Break-In Alert automatically re-enables when you either reenter the vehicle, or the next time the car is in P (Park).

- **CAUTION:** The sensor for the Tow & Break-In Alert is located in the center console of the vehicle and could accidentally be triggered by a large amount of force to that part of the vehicle.

## Disabling the alarm

If triggered, disable the Tow & Break-In Alert sequence by holding a valid key close to the vehicle or by double-clicking the key fob button.

04

# Seating & Safety Restraints

# Front Seats

## Adjusting the Front Seats

- **WARNING:** Do not adjust the driver's seat while driving. Doing so increases the risk of collision.
- **WARNING:** Before adjusting a seat, check that the area around the seat is free of obstacles.
- **WARNING:** Do not sit in or operate the vehicle until you adjust all seats and head restraints to their proper position. Failure to adjust seats and head restraints increases the risk of neck injury in the event of a crash.

Front seats can be adjusted using either the seat-mounted switches or the Pilot Panel.

### Using the Seat-mounted Switches

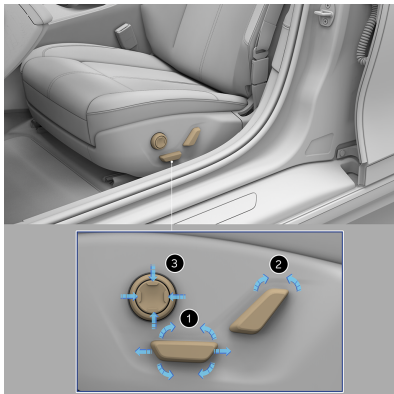

#### 1. Position

Move the seat forward/backward and adjust the seat's height and tilt angle up/down.



#### 2. Backrest

Rotate the switch backward/forward to adjust the angle of the seat back.

#### 3. Lumbar

Press the up/down buttons to raise/lower the lumbar support, and the left/right buttons to adjust the firmness of the lumbar support.

### Using the Pilot Panel

To adjust the seats using the Pilot Panel, select  >  SEATS.

Select the seat you want to adjust using the DRIVER or PASSENGER tabs.

Select the seat area you want to adjust from the side menu and then use the arrow icons to adjust the seat.

*Note:* The Headrest, Thigh Support, and Backrest Width cannot be adjusted using the seat switches.

After adjusting the seat position, touch the SAVE TO PROFILE button to save the seat position to your profile. The RESTORE button restores the driver seat position for the active profile. Additionally, the RESTORE button is active only when the vehicle is not in motion.

### Correct Seating Position

The seat, head restraint, seat belt, and airbags work together to maximize safety. Using these correctly provides greater protection.

- **WARNING:** Seat belts are intended for use by adult-sized occupants. For children, see [Child Safety](#) on page 41

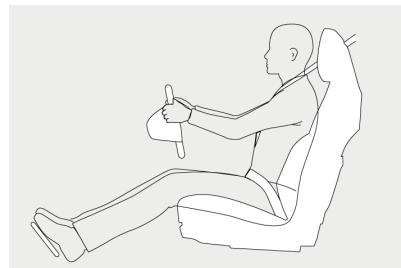



To reduce the risk of injuries in an accident, follow these instructions:

- The driver and front passenger position their seats so that they can correctly wear the seat belt while being as far away from the front airbags as possible.
- Sit upright, place both feet on the floor, and make sure that the seat back reclines no more than 30 degrees.
- Easily reach the pedals with your feet and slightly bend your arms while holding the steering wheel. The distance between the driver's chest and the center of the airbag cover should be at least 10 inches (254 mm).
- Grasp the steering wheel on the steering wheel rim. Hold your hands at the 3 o'clock and 9 o'clock positions to reduce the risk of injury to your hands or arms if the airbag deploys.
- Adjust the D ring position to position the shoulder section of the seat belt midway between your neck and your shoulder. Fit the lap section of the belt tightly as low and snug as possible around the hips, not the waist.

- **WARNING:** When the seat is in the reclined position, the shoulder belt and lap belt does not provide proper protection in an accident. You could slip past the shoulder belt, be thrown into the shoulder belt and receive neck or other serious injuries. You could also slide under the lap belt and receive serious internal injuries.

Message Feature

Both front seats have a seat massage feature to help prevent muscle fatigue and improve blood circulation when seated for long periods of time.



To control seat massage programs using the Pilot Panel, select  >  MESSAGE.

Select the required seating position using the DRIVER or PASSENGER tab. Select the message program you want to use from the side menu.

*Note:* If you previously used the massage feature, the massage feature selects the last used program and intensity.

Press the START MESSAGE button to activate the seat massage feature.

Each massage program runs for 20 minutes. A countdown showing the time remaining shows on the screen. To stop the massage program, press the STOP MESSAGE button.

The intensity of the massage can be increased or decreased by pressing the  or  icons.

Seat Heating and Ventilation

Both front seats have integrated seat heaters and ventilation.

To control seat heating and ventilation using the Pilot Panel, select . Press the corresponding icon to heat or ventilate the desired seat.

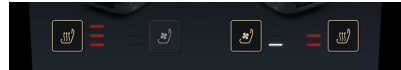

You can  heat or  ventilate the seats at three different levels.

- Press once to operate at the highest level. Three intensity indicators illuminate.
- Press twice to operate at the medium level. Two intensity indicators illuminate.
- Press a third time to operate at the lowest level. A single intensity indicator illuminates.
- Press a fourth time to turn off the selected feature.

Pressing one of the two zones on the seats deactivates heating or ventilation for that zone.

*Note:* Seat heating and ventilation cannot be used both together. Changing the seat heating to ventilation stops the seat heating and turns on the ventilation. Similarly, changing

---

the ventilation to seat heating stops the ventilation and turns on the seat heating.

# Rear Seats

## Rear Seat Folding

- **WARNING:** Secure objects carried within the vehicle. In an impact or sudden maneuver, unsecured objects can cause death or serious injury.

The split rear seat allows you to fold forward all or part of the seat to increase the load-carrying area. Before folding down a seat, remove any items on the seat or in the rear footwell and adjust the rear head restraints to the lowest position. See [Rear head restraints](#).

The rear seat release handles are located in the trunk. To fold down a rear seat, pull the corresponding release handle. After you feel the latch release, fold the seat forward from inside the passenger compartment.

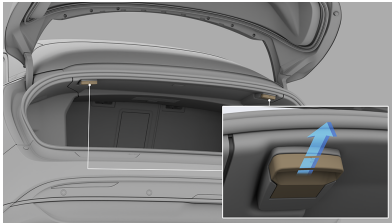

**Note:** To fold down the complete rear seat, use both release handles.

### Raising

To return the seat to its upright position, push it back until it locks in place. Make sure the seat back is locked in place by trying to pull the seat back forward.

- **WARNING:** When the seat back is in its upright position, make sure the locking mechanism fully engages. If the locking mechanism does not fully engage, the risk of death and serious injury increases in an accident or heavy braking.

**Note:** When returning the seat to its upright position, make sure the seat belts are not trapped behind the backrest.

## Rear Seat Pass-through

For your convenience when carrying long, narrow items, the rear seat has a pass-through hatch. This hatch allows you to carry long items without having to fold the rear seat forward.

To open the pass-through hatch:

1. Fold the rear seat armrest down.
2. Pull down on the latch and fold the pass-through hatch panel forward onto the rear armrest.

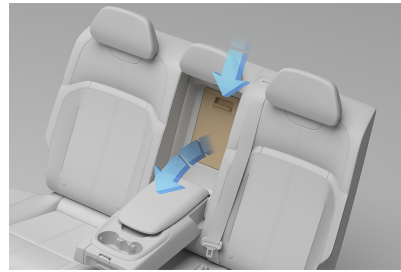

To close the hatch, push the panel up until the latch engages.

- **CAUTION:** When passing items through the hatch into the vehicle, make sure not to damage the upholstery on the seats and the armrests.

## Rear Seat Heaters

All rear seating positions have seat heaters in the seat base and seat back except the rear center seatback, which only has a heater function in the seat base.

Control the seat heating in the Pilot Panel (select  > REAR), the Rear Center Console Display (RCCD), or the capacitive buttons on either side of the RCCD.



Press the corresponding  heat icon to heat the desired seat. You can heat the seats at three different levels.

- Press once to heat at the highest level. Three intensity indicators illuminate.
- Press twice to heat at the medium level. Two intensity indicators illuminate.
- Press a third time to heat at the lowest level. A single intensity indicator illuminates.
- Press a fourth time to turn off the seat heater.

# Head Restraints

## Correct Head Restraint Position

- **WARNING:** In the event of a collision, you want the head restraint to contact your head first, not your neck. Improper positioning can result in serious injury, paralysis, or death.
- **WARNING:** All occupants, including the driver, must adjust the headrest to the proper position before operating the vehicle or sitting in the vehicle's seat to minimize the risk of neck injury in the event of a crash.

In addition to seat belts, head restraints are an important safety feature that, when used properly, can reduce the risk of personal injury (such as whiplash) in a collision. If the head restraints are not adjusted correctly, risk of injury increases.

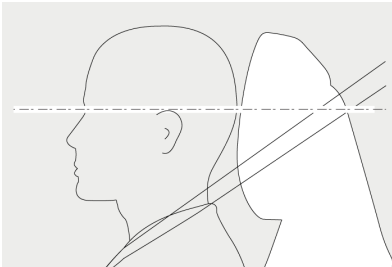

- Adjust the head restraint so the height of the restraint is at the top of the occupant's head. Doing so will place the thickest portion of the restraint behind the person's head at ear level.
- Adjust the head restraint so the distance of the restraint is as close as possible to the back of the head.

## Adjusting the Head Restraints

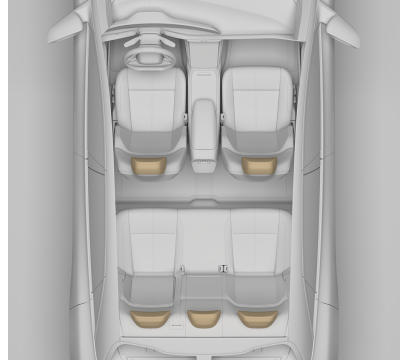

Your vehicle has an adjustable head restraint for each seating position, with the exception of the rear center seat.

### Front head restraints

*Note:* The position of the front seat head restraints can only be adjusted using the Pilot Panel. See [Using the Pilot Panel](#).

### Rear head restraints

- **WARNING:** Do not position the rear head restraint to the lowest position for an occupied rear seat. The lowest position for a rear head restraint is in a storage position to provide maximum visibility out of the rear window.

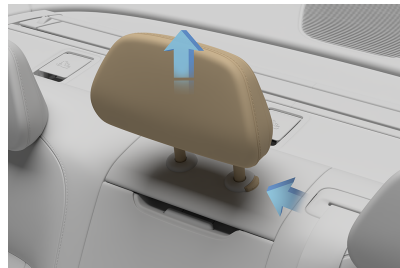



---

For an occupied rear seat, press the button at the base of the head restraint and move the restraint upward to at least the first locked position. Make sure the head restraint is in a locked position during height adjustment.

The rear center head restraint is not adjustable, only removable.

### Removing a head restraint

- **WARNING:** If the passenger's head protrudes above the top of the seat back, do not drive or carry passengers with the head restraints removed from the occupied seats. The absence of a properly adjusted head restraint increases the risk of serious injury or fatality in the event of a collision.
- **WARNING:** Remove the head restraint from the vehicle seat when installing a child safety seat (with the exception of booster seats) to make sure that the upper tether strap securely holds the child safety seat in place.

To remove a head restraint, press the button at the base of the head restraint, then pull up until the head restraint slides out completely.

### Reinstalling a head restraint

- **WARNING:** Any head restraint that has been removed must be reinstalled to properly protect vehicle occupants.

To reinstall a head restraint, locate the head restraint bars into the head restraint locating holes, push the button on the side of one of the locating holes, and push the head restraint down until a positive lock occurs.

# Seat Belts

## Seat Belt Warnings

---

- **WARNING:** It is the driver's responsibility to ensure occupants of the vehicle are wearing seat belts and adhering to all warnings and guidelines listed in this section.
- **WARNING:** Make sure the driver and passengers wear the seat belts correctly. Improperly wearing a seat belt increases the risk of injury or death in a collision.
- **WARNING:** Always wear the seat belt with the lap section of the belt as low as possible and snug across your hips.
- **WARNING:** Do not wear the seat belt with any part of the strap twisted.
- **WARNING:** Never wear the seat belt with the shoulder belt under your arm.
- **WARNING:** Never wear a shoulder belt without the lap belt.
- **WARNING:** Do not wear seat belts over hard, fragile, or sharp items in clothing (for example, pens, keys, and eyeglasses). Pressure from the seat belt on such items can cause personal injury.
- **WARNING:** Each seat belt should only be used by one occupant. Never attempt to use a seat belt with a child or another person in your lap.
- **WARNING:** Secure small children in a proper child safety seat.
- **WARNING:** If a seat belt cannot be securely fastened because it is not long enough, only use Lucid-approved seat belt extenders.
- **WARNING:** Using seat belt extenders may not allow the vehicle to determine whether a seat belt unlatches.
- **WARNING:** Do not make modifications or additions to the seat belt assembly that prevent the mechanism from taking up or removing slack. A slack

belt greatly reduces the occupant's protection.

- **WARNING:** Do not attempt to remove, repair, disassemble, or install seat belts. Lucid recommends that Lucid Certified Technicians should perform any necessary repairs. Improper handling may result in the seat belts failing to operate correctly.
- **WARNING:** Avoid contaminating the seat belt assembly with any liquids, chemicals, dirt, grit, or cleaning products. Contamination can affect the condition and function of the assembly.
- **WARNING:** Seat belts showing signs of wear (such as fraying), have been cut, or otherwise damaged, must be replaced by a Lucid Service Center.
- **WARNING:** If a seat belt fails to latch or does not fully retract when not in use, contact Lucid Customer Care to have the assembly inspected and possibly replaced.
- **WARNING:** Any seat belts that were in use during a collision must be inspected or replaced by Lucid Certified Technicians, even if there is no apparent damage to the assembly.
- **WARNING:** Take care not to damage the seat belt by allowing any part of it to become trapped in the door.

## Wearing Seat Belts

---

- **WARNING:** All occupants must wear seat belts no matter the driving distance. Failure to do so increases the risk of serious injury or fatality in an accident.

Seat belts and child restraint systems are the most effective means of restraining vehicle occupants from impact forces, which minimizes the danger of injury from interior impacts and the effects of whiplash. Wearing a seat belt is required by law in most states.

All seating positions are equipped with three-point inertia retractor seat belts. Inertia retractor seat belts are tensioned automatically and allow freedom of movement during normal driving conditions.

The seat belt retractor automatically locks, preventing occupants' movement whenever your vehicle experiences the force associated with hard acceleration, braking, cornering, or impact in a collision. The retractor may also lock when driving on steep hills or slopes.

### Automatic Locking Retractor (ALR)

All rear passenger seating positions are equipped with an Automatic Locking Retractor (ALR) to securely hold child safety seats. When the seat belt completely extends and then allowed to retract (even slightly), the retractor locks so that it cannot be extended. To disengage the ALR, allow the belt to fully retract.

The front passenger seat has an ALR.

- **WARNING:** Lucid does not recommend installing a child seat in the front passenger seat.

#### Fastening the Seat Belt

1. Position the seat correctly. See [Correct Seating Position](#).
2. Pull the seat belt out slowly, making sure that it is not twisted or damaged.
3. Buckle the seat belt by inserting the latch patch fully into the buckle. A distinct "click" indicates that the seat belt is securely locked in place.

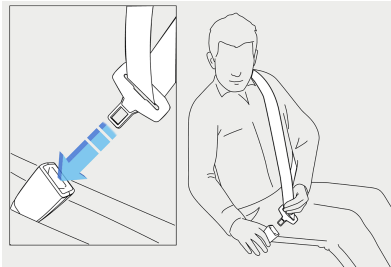

4. The height adjuster of the front seat belts can be adjusted.

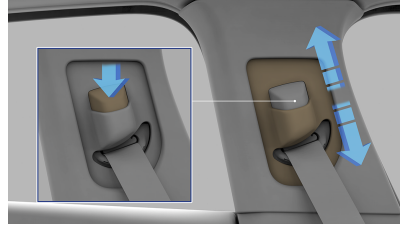

Press the button on the seat belt adjuster on the door pillar and move the belt up or down. Adjust the seat belt to the highest position possible for the seat belt to be mid-way between the shoulder and the neck, on the collar bone.

5. Tighten the seat belt across the lap and rest the seat belt on the hips by pulling the diagonal section up towards the shoulder.

### Releasing the belt

To release the seat belt, press the red button on the buckle. The seat belt automatically retracts.

#### Seat belt reminders

- **WARNING:** All occupants must wear seat belts. Never disregard or attempt to disable the seat belt reminder if it activates.



The seat belt reminder on the Cockpit Panel alerts you if a seat belt for an occupied front or rear seat is unbuckled.

If the vehicle speed is less than 12 mph (20 km/h), the red warning indicator solidly illuminates, with no warning chime.

If the vehicle speed is more than 12 mph (20 km/h), the red warning indicator flashes continuously and an intermittent chime sounds.

If all occupants are wearing seat belts and the warning indicator stays on, re-fasten all seat

belts in use to make sure they are correctly latched. Remove any heavy objects (such as a briefcase) from any unoccupied seats. If the indicator remains on, contact a **Lucid Service Center**.

In addition to the seat belt reminder, a graphic of the seat layout displays on the left side of the Cockpit Panel. The seat layout displays the detected occupied seats and the seat belt use status.



When the seat location displays a green indicator, it indicates that the seat position is occupied and the seat belt is fastened.



When a seat location displays a red seat belt indicator, it indicates that the seat position is occupied but the seat belt is not fastened.

#### Using Seat Belts When Pregnant

- **WARNING:** Pregnant women must wear seat belts to protect themselves and their unborn child.
- **WARNING:** Do not place anything between you and the seat belt to cushion the impact in the event of a collision.

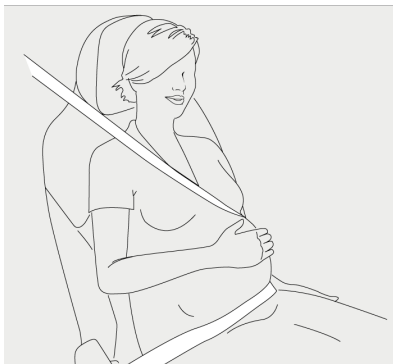

Wear the lap portion of the seat belt as low as possible across the hips, not the waist. Position the shoulder part of the belt between the breasts and to the side of the abdomen. Make sure that the seat belt has no slack and is not twisted.

For any concerns about wearing seat belts, consult with your physician.

#### Seat Belt Pre-tensioners

- **WARNING:** If a seat belt pre-tensioner activates, it must be replaced. After an impact or collision, even if there is no obvious damage, always have the seat belts checked and (if necessary) replaced by a Lucid Service Center.

The seat belts for the front and outboard rear seating positions are equipped with pre-tensioners that work either independently or in conjunction with the airbags in a severe front or side-impact collision, depending upon the severity of a crash.

*Note:* A pre-tensioner activates if the seat belt is already buckled at the time of the collision.

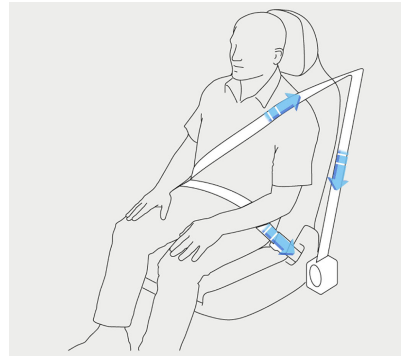

The pre-tensioners automatically retract the seat belts, reducing any slack in both the lap and shoulder portions of the belts, thereby reducing the forward movement of the seat belt wearer.

The seat belt pre-tensioners can only activate once before a **Lucid Service Center** must replace them.



If a pre-tensioner activates, the airbag warning indicator displays on the Cockpit Panel.

*Note:* Even if the pre-tensioners activate, the seat belts still function as restraints. Continue to wear the seat belts if the vehicle remains in a drivable condition.

- **WARNING:** Regularly check the condition of all seat belts. Replace seat belts if you notice damage to the belt straps, fittings, retractor mechanisms, or buckles. Damaged seat belts may not operate properly in the event of an accident.
  
- **WARNING:** When seat belts are not in use, they should be fully retracted and not hanging loose. If a seat belt does not fully retract, contact a Lucid Service Center.

There are three tests you should perform when checking seat belts:

1. With the seat belt fastened, give the shoulder belt strap at the buckle a quick upward pull. The buckle should remain securely locked.
  
2. With the seat belt unfastened, unreel the belt to its limit. Check that it unreels smoothly with no snatches or snags. Visually check the belt for wear. Allow the belt to retract, checking that retraction is smooth and complete.
  
3. With the belt half unreeled, hold the strap and quickly try to pull more strap out. The mechanism must lock automatically and prevent further unreeling.

If any issues arise during these tests, contact a **Lucid Service Center** immediately to have the seat belt replaced.

# Child Safety

## Guidelines for Seating Children

All child restraint systems are designed to be secured by lap belts or the lap belt portion of the lap-shoulder belt.

- **WARNING:** Do not use a child restraint on a seat with an operational airbag in front of it. There is a risk of death or serious injury when the airbag deploys. Crash statistics show that children are safest when properly restrained in a child or infant restraint system that is secured in a rear seating position.
- **WARNING:** Do not use a forward-facing child seat until the child using it is above the minimum weight of 20 lb (9 kg) and able to sit up unaided. Up to the age of two years, a child's spine and neck are not sufficiently developed to avoid injury in a frontal impact.
- **WARNING:** Do not allow a baby or infant to be held or carried on the lap. The force of a crash can increase effective body weight by as much as 30 times or higher, depending upon the crash severity, making it impossible to hold onto the child. At all times, restrain children in age- and size- appropriate child seats to reduce the risk of injury in a crash.

Lucid designed and fitted your vehicle's seat belts for adults and larger children. For the safety of infants and children under 12, it is important to restrain them in a suitable child safety seat appropriate for their age and size. Fit a child seat that has been approved for use in your vehicle. Follow the manufacturer's fitting instructions exactly. You can contact **Lucid** for a list of approved child seats. See [Contacting Lucid Motors](#) on page 211. The rear seat supports both iSize and ISOFIX child seats.

*Note:* Legislation that governs how and where children should be carried when traveling in a vehicle is subject to change. It is the responsibility of the driver to comply with all current regulations.

- **WARNING:** Do not use a rear-facing child restraint on a seat protected by an airbag in front of it. In the event of an airbag deployment, this could lead to serious injury or fatality of a child seated in a front seat.

While it is possible to disable the front passenger airbag, this should not be relied upon to protect your child. **Lucid** strongly advises that you **DO NOT** use a rear-facing child seat on the front passenger seat.

## Choosing a Child Safety Seat

- **WARNING:** Children age 12 and under should ride in the rear seats using a child safety seat suitable for the child's age and weight.
- **WARNING:** Children should ride rear-facing and use the child restraint's integrated 5-point harness in conformity with possible local laws and the recommendations of the Child Safety Seat manufacturer. Check to make sure children riding in your vehicle are riding in the appropriate child restraint.

Child restraints accommodate different ages, sizes, and weight ranges of children. Many child restraints are designed to allow children to ride rear-facing. Carefully read and follow all instructions and warnings provided by the child safety seat manufacturer, and on all labels attached to the child safety seat.

Use the following tables to help you determine the best type of restraint for a child. There are also some general rules for each category.

Weight Group		Rear Outer Seat	Rear Center Seat
Group 0	Under 22 lb (10 kg)	U	-
Group 0+	Under 29 lb (15 kg)	U	-
Group 1	20-40 lb (9-18 kg)	U, UF	-

Weight Group		Rear Outer Seat	Rear Center Seat
Group II	55-55 lb (15-25 kg)	U, UF	-
Group III	48-76 lb (22-36 kg)	U, UF	-

U: Universal belt rearward child restraint system

UF: Universal belt forward child restraint system

Weight Group		Front Passenger Seat	Rear Outer Seat	Rear Center Seat
Group O	Under 22 lb (10 kg)	-	II.	-
Group O+	Under 29 lb (15 kg)	-	II.	-
Group I	20-40 lb (9-18 kg)	-	II.	-
Group II	55-55 lb (15-25 kg)	-	II, IUF	-
Group III	48-76 lb (22-36 kg)	-	II, IUF	-

II: Any semi-universal LATCH/ISOFIX child restraint system

IUF: Any universal LATCH/ISOFIX child restraint system

#### Seating Larger Children

- **WARNING:** Make sure the booster seat or vehicle seat properly supports the child's head. The seat back must be at or above the center of the child's ears.
- **WARNING:** Make sure to properly fit the vehicle seat belt onto the child with the shoulder portion of the belt away from the face and neck and the lap portion of the belt lying across the child's lap, not over the stomach.
- **WARNING:** When a booster seat is not in use, do not leave it loose in the vehicle. In a sudden stop or collision, it could strike the occupants or seat backs and cause serious injury. Secure the booster seat or remove it from the vehicle entirely.

If a child is too big to fit into a child safety seat but too small to safely fit into the standard seat belts, use a booster seat appropriate for the child's age and size.

Carefully read and follow all the instructions, warnings, and labels attached to the booster seat and provided by the booster seat's manufacturer.

Always check and adjust every child's seat belt for every trip.

Children who are big enough to wear the shoulder belt properly and comfortably, and whose legs are long enough to bend over the front of the seat when their back is against the seat back, should use the seat belt in a rear seat.

#### Installing Child Safety Seats

- **WARNING:** When installing any child safety seat, it is strongly recommended to always remove the head restraint from the vehicle seat.
- **WARNING:** Correctly anchor child safety seats. Incorrectly anchoring the child safety seats may result in a significant risk of injury to the child in the event of a collision or emergency braking.
- **WARNING:** After installing a child safety seat in the vehicle, do not adjust the vehicle seat, as this can loosen the safety seat attachments. Remove the safety seat before adjusting the vehicle seat position. When the vehicle seat has been adjusted, reinstall the safety seat.

Not all child restraint systems are the same, and they do not all install in the same way. There are two types of installations:

- Those that you secure to the vehicle seats by the seat belts; and
- Those that you secure using LATCH/ISOFIX child seat anchor points built into the rear seat frame.

All new and most older child restraint systems also use an upper tether strap that attaches to an anchorage point on the parcel shelf.

*Note:* Check the manufacturer's instructions to see which installation method to use.

For some systems, you can use either installation method. Always follow the child restraint manufacturer's instructions and recommendations.

Installing LATCH or ISOFIX Child Seats

- **WARNING:** Child seat anchorages are designed only to withstand the loads imposed by a correctly installed child safety seat. Under no circumstances are they to be used for adult seat belts, harnesses, or attaching other items or equipment to the vehicle.
- **WARNING:** Never attach two child safety seats to one anchor point. In a collision, one anchor point may be incapable of securing both seats.
- **WARNING:** If the restraint is not correctly anchored, there is a risk of serious injury to the child in the event of a collision or emergency braking.

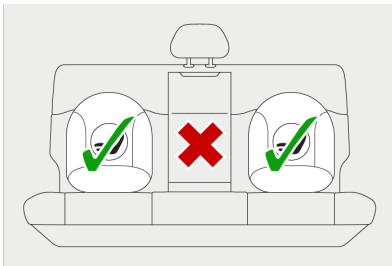

The outer rear seats are equipped to accept LATCH/ISOFIX restraints.

**Note:** Only a seat belt retained child seat can be used in the center rear seating position.

To install a LATCH/ISOFIX child seat:

1. The lower LATCH/ISOFIX anchorage points are located between the seat back rest and rear cushion, indicated by child seat identification tabs on the seat.

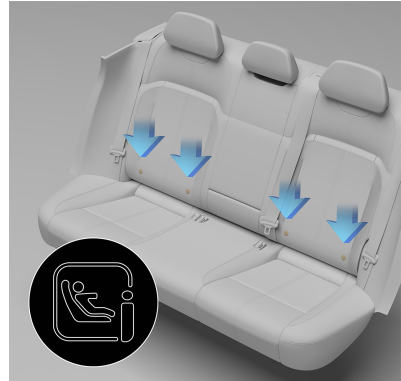

2. Position the child seat on the vehicle seat.
3. Attach the child seat latches onto the LATCH/ISOFIX lower anchor points, following the manufacturer's instructions to connect and tighten them.

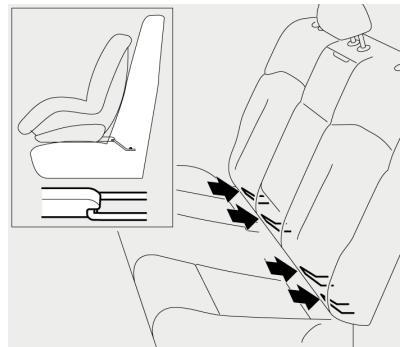

4. Securely connect and tighten the latches. To do this, attempt to pull the child seat away from the vehicle seat and twist it from side to side. Even if the child seat appears secure, check the anchor points visually to make sure for correct attachment.

If the child seat moves more than 1 inch (2.5 cm) from side to side or front to back, it is too loose. If you cannot tighten the latches any further, try a



different recommended seating location or another child safety seat.

5. If the child seat has an upper tether provided, fit and tighten the upper tether correctly. See [Attaching Upper Tether Straps](#).

- **WARNING:** When the combined weight of the child plus the child restraint is more than 64 lb (29 kg), you should not use the lower LATCH/ISOFIX anchors with the child seats or booster seats that have an integrated safety belt. Use the seat belt instead.

#### Installing Seat Belt Retained Child Seats

First, make sure that the child falls into the correct weight range for the child seat being used. See [Choosing a Child Safety Seat](#) on page 41.

The following is a general procedure for installing a seat belt retained child restraint. You should always read and follow the instructions provided by the manufacturer of the child safety seat you are installing.

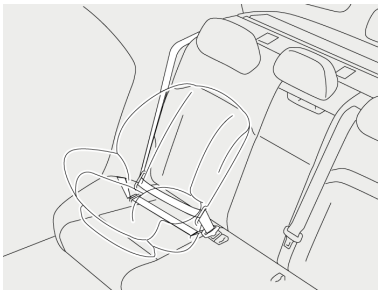

1. Place the child safety seat in the vehicle seat and fully extend the seat belt to engage the ALR. See [Automatic Locking Retractor \(ALR\)](#). Route the seat belt to secure the child safety seat and secure the buckle following the manufacturer's instructions.
2. Allow the seat belt to retract. Firmly push the safety seat into the vehicle seat and remove all slack in the seat belt.

3. If the safety seat has an upper tether, attach it to the back of the vehicle seat. See [Attaching Upper Tether Straps](#).
4. Check that the safety seat is not loose. Do this by holding the safety seat by the belt path and sliding it side to side and front to back.

If it moves more than 1 inch (2.5 cm) from side to side or front to back, then it is too loose. If you cannot tighten the safety seat any further, try a different recommended seating location or another child safety seat.

Attach a child safety seat using the lap belt or the lap belt portion of a lap-shoulder belt in accordance with the instructions of the manufacturer of the child seat.

- **WARNING:** Children could be endangered in a crash if their child restraints are not properly secured in the vehicle.

#### Attaching Upper Tether Straps

There are upper tether strap anchors provided for each rear seating position.

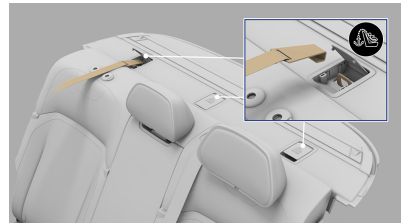

To attach the tether straps:

1. Remove the head restraint from the vehicle seat.
2. Pass the tether strap over the top of the seat.
3. Open the protective cover located behind the headrest.

4. Attach the tether strap hook to the tether anchor point on the parcel shelf.  
Ensure that the tether strap hook is facing the correct way according to the manufacturer's instructions and that the strap is not twisted.
  5. Tighten the tether strap according to the manufacturer's instructions.
- **CAUTION:** To prevent damage to the tether anchor point cover, it must be closed when lowering the rear sunshade.

---

#### Child Safety Seat Warnings

---

- **WARNING:** To ensure children are safely seated, follow all instructions provided in this document and by the manufacturer of the child safety seat.
- **WARNING:** Always check and adjust every child's safety harness or seat belt for every trip.
- **WARNING:** Avoid dressing the child in bulky clothing (such as thick or puffy coats) and do not place any objects between the child and the restraint system, as these practices could introduce slack to the restraints and reduce their effectiveness.
- **WARNING:** Children should never be left unattended in the vehicle, even when secured in a child safety seat.
- **WARNING:** According to collision statistics, children are safer when properly restrained in the rear seats than in the front seat.
- **WARNING:** Never use seat belt extenders on a seat belt that is used to install a child safety seat or booster seat.
- **WARNING:** Regularly inspect and check the installation of all child safety seats. Replace any seats or harnesses that show signs of wear.
- **WARNING:** Never use a child safety seat that has been in a collision. Have the seat inspected or replaced as described in the child safety seat manufacturer's instructions.

# Airbags

## Location of Airbags and Airbag Sensors

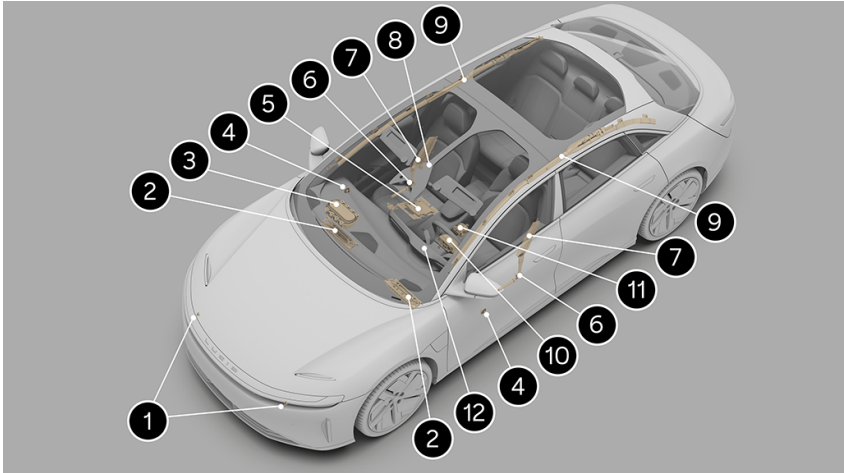

1. Front impact sensors
2. Knee airbag
3. Front passenger's airbag
4. Side impact sensor (front door)
5. Passenger seat OCS sensor
6. Front seat belt pre-tensioner
7. Side airbags (seat-mounted)
8. Passenger airbag status indicator (overhead console)
9. Curtain airbag
10. Driver's airbag
11. Airbag control module
12. Airbag SRS warning indicator

*Note:* The illustration shows approximate airbag locations.

Airbag Safety Information

- **WARNING:** Even with airbags, the driver and occupants must always wear their seat belts to minimize the risk of severe injury or death in the event of a collision.
- **WARNING:** Do not attach or place objects on or near the front airbags, the side of the front seats, the headliner at the side of the vehicle, or any other location that could interfere with the inflation of an airbag. Objects can cause serious injury if the vehicle is in a collision severe enough to cause the airbag to deploy.
- **WARNING:** For the curtain airbags to deploy correctly, the roof lining and A-post trim must be undamaged and installed correctly. Any damage or suspect installation should be referred to a Lucid Service Center for inspection.
- **WARNING:** Front-seat occupants should not place any part of their arms, body against the steering wheel or dashboard area, as an inflating airbag can cause fractures or other injuries.
- **WARNING:** Do not use seat covers in the vehicle. A seat cover could interfere with the deployment of the seat-mounted side airbags in the event of a collision.
- **WARNING:** Airbags inflate with considerable speed and force. To reduce the risk of injuries, ensure that all occupants are wearing seat belts and are correctly seated, with seats positioned as far back from any front airbags as possible.
- **WARNING:** Never use a child safety seat or seat young children on a seat with an operational airbag in front of it. Doing so can cause serious injury or death if the airbag deploys.
- **WARNING:** To ensure correct inflation of the side airbags, maintain an unobstructed gap between an occupant's torso and the side of the vehicle.
- **WARNING:** Occupants should not lean their heads against doors. Doing so

can cause injury if a curtain airbag deploys.

- **WARNING:** Do not allow occupants to obstruct the operation of an airbag by placing feet, knees, or any other part of the body on or near an airbag.
- **WARNING:** Contact Lucid first if you are planning to modify your vehicle for a person with disabilities in a way that may affect the airbag system. See [Contacting Lucid Motors](#).

Airbag Safety Labels

Airbag safety labels are on the sun visors for the driver and front passenger.

How the Airbags Work

- **WARNING:** The airbags are a Supplemental Restraint System, providing additional protection in certain types of collisions only; they do not replace the need to wear a seat belt.
- **WARNING:** Occupants not properly restrained in designated seating positions are at high risk of death or serious injury in the event of airbag deployment.
- **WARNING:** Do not use a child restraint on a seat with an operational airbag in front of it. There is a risk of death or serious injury if the airbag deploys.

Airbags inflate when sensors detect an impact that exceeds deployment thresholds. These thresholds are designed to predict the severity of a crash in time for the airbags to help protect the vehicle's occupants.

Airbags inflate instantly and with considerable force, accompanied by a loud noise. The inflated airbag and the worn seat belts limit the occupants' movement to reduce the risk of injury.

The front airbags are not designed to inflate as a result of:

- Rear collisions
- Vehicle rollover

- Slow speed front impacts
- Side impacts
- Driving over bumps or potholes

Therefore, significant superficial damage can occur to the vehicle without the airbags inflating or, conversely, a relatively small amount of not easily visualized structural damage can cause airbags to inflate.

#### Types of Airbags

### Front airbags

The front airbags are designed to protect the head and chest of the driver and front passenger from impact with the steering wheel and dashboard panel components.

The front airbags fitted to your vehicle are advanced airbags. This type of airbag is designed to reduce airbag-related injuries to small-statured adults.

An occupancy sensor is built into the front passenger seat. If the sensor detects the weight of an infant or small child, the system will automatically turn off the passenger's front airbag. However, **Lucid** does not recommend that you seat an infant or small child in the front passenger seat.

No objects should be placed over or near the airbag on the instrument panel because the object could cause harm if the vehicle is in a crash.

*Note:* If there is no front seat passenger detected, the passenger front airbag will not activate. .

### Side airbags

- **WARNING:** Maintain a gap between the side of the vehicle and the torso; this enables correct inflation of the seat-mounted side airbags.
- **WARNING:** Do not use seat covers or accessory seat covers on a front seat, as these will prevent the side airbag from deploying correctly in an accident. If in doubt, contact a Lucid Service Center.
- **WARNING:** Lucid recommends a Lucid Service Center performs all repairs. Incorrectly performed repairs to the

side airbag system could impair function and lead to serious injury or death.

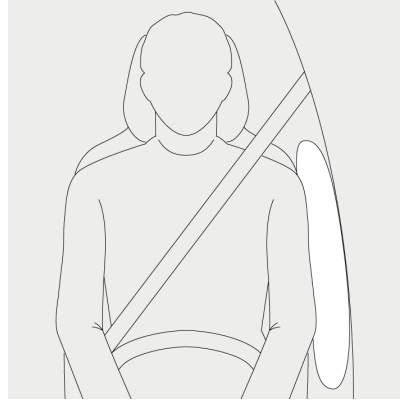

The side airbags are designed to protect the thorax region of the torso and pelvis and only deploys in the event of a severe side impact. They do not inflate as a result of frontal or rear impacts only. The airbags on the non-impacted side of the vehicle do not deploy.

### Knee airbags

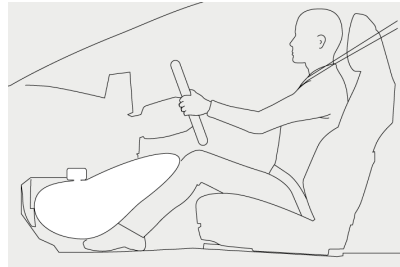

The knee airbags are designed to work in conjunction with the deployment of the front airbags. When deployed, the knee airbags limit the forward motion of the driver or front passenger by restricting leg movement, thereby positioning the occupant so that the front airbags work more effectively.

**Curtain airbags**

- **WARNING:** Make sure that passengers do not lean their heads against the doors. In the event of a collision, the curtain airbag deploys from the headliner and may cause injury.
- **WARNING:** Never hang or attach heavy objects from the grab handles on the headliner. The hooks are for lightweight garments (not for hard objects).

The curtain airbags are designed to protect the head in severe frontal crashes with a lateral component, severe side impacts, or rollovers. They do not inflate in all frontal impacts and do not inflate alone in a rear impact.

*Note:* Curtain airbags can help prevent occupants from being thrown from the vehicle in the event of a vehicle rollover.

Obstruction of Airbags

- **WARNING:** Do not allow passengers to obstruct the operation of the airbags by placing feet, knees, any other part of the body, or any other objects in contact with, or in close proximity to, an airbag module.
- **WARNING:** Do not attach or position items on an airbag cover that could interfere with the inflation of the airbag or be propelled inside your vehicle and injure occupants.
- **WARNING:** Never place your arm over an airbag cover. A deploying airbag can cause serious fractures or other injuries.

For the airbags to correctly deploy, obstructions cannot intervene between an airbag and the occupant.

The following are examples of the type of obstructions that could impede the correct operation of the airbags or jeopardize personal safety in the event of an airbag deployment:

- Accessories attached to or obscuring an airbag cover (for example, attached to the roof lining, door pillar trim, or the front seat backrests)

- Items of hand luggage, or other objects placed on an airbag cover
- Feet, knees, or any other part of the anatomy in contact with, or in close proximity to, an airbag cover
- Head, arms, or any part of the anatomy in contact with, or in close proximity to, a seat-mounted side airbag
- Objects (such as items of clothing) hanging from the handles attached to the headliner
- Objects (such as items of clothing or cushions) draped over the part of the front seat containing the airbag
- Seat covers/accessory seat covers over a front seat; in particular, seat covers that have not been designed for use with seat-mounted side airbags. If in doubt, consult your **Lucid Service Center**.

- **WARNING:** Lucid strongly advises against seating a child on the front passenger seat, even if the passenger airbag is Off. All occupants age 12 and under should ride in the rear seats. See [Child Safety Locks](#) on page 21.
- **WARNING:** The full weight of the front seat passenger should always be directly on the seat cushion. The passenger should never lift themselves off the seat cushion by using the armrest in the door or the center console, by pressing their feet on the floor, by sitting on the edge of the seat cushion, or by pressing against the backrest in a way that reduces pressure on the seat cushion. The passenger should never place anything (such as a cushion) between themselves and the seat that could cause OCS to disable the front passenger's airbag.

Deployment of the front passenger airbag is not always beneficial for small or lower-weight occupants and could be harmful to children/infants in restraint systems.

The front passenger seat is fitted with an occupancy sensor that controls the status of the front passenger airbag based on the weight of the occupant.

*Note:* The occupancy sensor system only controls the deployment of the front passenger airbags and passenger side airbag. It does not affect the deployment of the seat belt pre-tensioner or the passenger curtain airbag.

The occupancy sensor system meets the regulatory requirement of FMVSS 208 and automatically detects when deployment of the front passenger airbag may be unnecessary or potentially harmful.

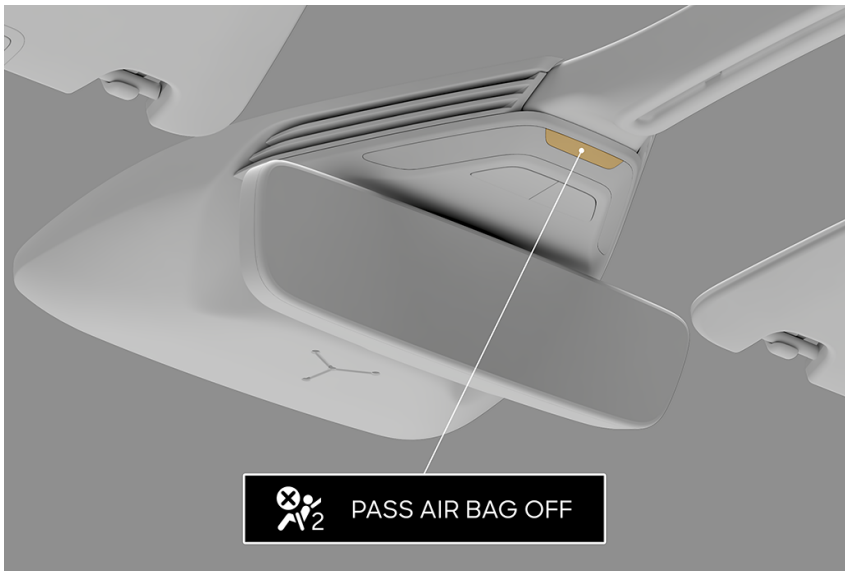

A status message on the overhead console indicates whether the front passenger airbag is currently OFF.

You should always check whether the passenger airbag status indicator shows the correct status for the current seat occupancy.

If you think the passenger airbag status is incorrect, check for the following:

- Objects lodged underneath the seat
- Objects wedged between the seat cushion and the center console
- Objects hanging off the back of the seat
- Cargo interference with the seat
- Rear-seat passengers pushing or pulling on the front passenger seat

Any of the conditions listed above may cause the occupancy sensor to incorrectly interpret the weight of the occupant or object as either heavier or lighter than the real weight.

Depending on the input received from the occupancy sensor, the passenger airbag status indicator operates as follows:

Front Passenger Seat Occupancy	Passenger Airbag Status	Passenger Airbag Status Indicator	Airbag SRS Warning Indicator
Completely empty/ low-weight object <sup>1</sup>	Deactivated	OFF	-
Child restraint seat with infant	Deactivated <sup>2</sup>	OFF	-
Child	Deactivated <sup>3</sup>	OFF	-
Adult	Activated <sup>4</sup>	ON	-
System malfunction	Deactivated	OFF	ON

<sup>1</sup> A low-weight object or occupant is classified as weighing less than 52 lb (23.5 kg). The movement of a low-weight occupant or object while your vehicle is in motion may cause the status indicator to switch states occasionally.

<sup>2</sup> Never install a rear-facing child restraint system on the front passenger seat. A forward-facing child restraint system should only be installed on the front passenger seat when it is unavoidable.

<sup>3</sup> For some children (a child in a seat, booster seat, or convertible seat), the system may not recognize them as a child. Factors that may affect this can be the physique or posture.

<sup>4</sup> The system judges a person of adult size as an adult. When a smaller adult sits in the front passenger seat, the system may not recognize them as adults, depending on their physique and posture.

*Note:* It is possible to receive an intermittent indicator status with an empty seat. This is part of the system's behavior and it does not affect the status of the front passenger airbags. However, if the status indicator is not permanently illuminated when the seat is empty, contact a **Lucid Service Center** immediately.

If you still believe that the airbag status indicator is incorrect, have your passenger ride in the rear of the vehicle and contact a **Lucid Service Center** to have the system checked.



---

## Front passenger seat OCS precautions

- **WARNING:** Failure to observe the following precautions regarding the front passenger OCS may cause death or serious injury.
  - Wear the seat belt properly. See [Wearing Seat Belts](#) on page 37.
  - Make sure the front passenger's seat belt latch plate is not inserted into the buckle before someone sits in the front passenger seat.
  - If an adult is seated in the front passenger seat, and the PASS AIR BAG OFF indicator is displayed, ask the passenger to sit up straight, well back in the seat, with feet on the floor, and with the seat belt worn correctly. If the PASS AIR BAG OFF indicator remains displayed, ask the passenger to move to a rear seat or move the front passenger seat fully rearward. In either case, contact a Lucid Service Center to help correct the issue.
  - Child restraint systems installed on the rear seat should not contact the front passenger seat back.
  - Do not recline the front passenger seat back so far that it contacts a rear seat or an object in the rear of the vehicle. This may cause the PASS AIR BAG OFF indicator to be displayed. Return the seat back to a position where it does not touch the seat or object. Keep the front passenger seat back as upright as possible when the vehicle is moving. Reclining the seat back may lessen the effectiveness of the seat belt system.
  - Make sure the PASS AIR BAG OFF indicator is not displayed when using a seat belt extender for the front passenger. If the PASS AIR BAG OFF indicator is displayed, disconnect the latch plate from the seat belt buckle and reconnect the seat belt. If you continue to use the seat belt extender while the PASS AIR BAG OFF indicator is displayed, the airbags for the front passenger will not activate correctly. This could cause death or serious injury in the event of a collision.
  - Do not apply a heavy load to the front passenger seat.
  - Do not put objects underneath the front passenger seat.
  - Do not allow rear seat passengers to put weight on the front passenger seat by putting their hands or feet on the seat back.
  - Do not let a rear passenger lift the front passenger seat with their feet or press on the seat back with their legs.
  - Do not allow a passenger to kick the front passenger seat or subject it to a severe impact. This could cause the Airbag SRS warning indicator to be displayed and prevent the system from operating correctly in an impact. Contact a **Lucid Service Center** if the warning indicator is displayed.
  - Do not modify or remove the front seats.
  - Do not modify, cover, or replace the upholstery on the front seat.

Effects of Airbag Inflation

- **WARNING:** When airbags deploy, a fine powder is normally released. This powder can cause irritation. Thoroughly flush the powder from the eyes and skin, including any cuts or abrasions. The powder may aggravate asthma for some people.
- **WARNING:** Following inflation, some airbag components are hot. Do not touch until they have cooled.

After inflation, the airbags deflate to provide a gradual cushioning effect, and also to clear the driver's field of vision.

If airbags inflate or your vehicle has been in a collision, always have the airbags, seat belt, and all associated components checked and (if necessary) replaced by **Lucid**.

**Safety features**

Along with the inflation of the airbags, the following also occurs to assist you and any recovery personnel:

- Doors unlock
- Hazard warning lights turn on
- Interior lights turn on
- High-voltage power is isolated

Airbag SRS Warning Indicator



You will be alerted of an airbag system malfunction with a red warning indicator on the Cockpit Panel.

The components monitored by the system include:

- Airbag modules
- Seat belt pre-tensioners
- Airbag diagnostic control unit
- Crash sensors
- Airbag wiring harnesses

- Seat occupancy sensors
- Seat belt buckle sensors

When the vehicle is On, the airbag control unit monitors the readiness of the system's electrical circuits.

You should contact a **Lucid Service Center** if the warning indicator:

- Fails to illuminate when the vehicle starts.
- Fails to extinguish within approximately 6 seconds after the vehicle starts.
- Illuminates while driving the vehicle.

Airbag Service Information

- **WARNING:** Do not attempt to service, repair, replace, or modify any part of the airbag system. This includes wiring or components in the vicinity of the airbag components. Doing so may cause the system to trigger or render the system inoperative, either of which may result in death or serious injury.
- **WARNING:** Any notable damage to airbag components or covers (for example, tears, burns, holes, chemical or detergent damage, or previous accidental damage), however produced, may cause the airbag module(s) to fail. Make sure a Lucid Service Center repairs or replaces any damaged components.
- **WARNING:** If you need to dispose of an airbag or seat belt pre-tensioner, contact a Lucid Service Center. Incorrect disposal procedures could cause personal injury.



05

# Driving & Operating

# Driver Information

## Vehicle Information and Alerts

---



To access information about your vehicle, select  >  About Vehicle on the Pilot Panel. This screen provides information including:

1. Vehicle model
2. Vehicle Identification Number (VIN)
3. Vehicle software version
4. Alerts that were recently displayed on the Cockpit Panel

*Note:* If new alerts are available, a notification badge appears on the  About Vehicle icon.

## Trip Information

---

Trip information is displayed on the left vehicle widget of the Cockpit Panel. To reset or change the display, select  >  Vehicle on the Pilot Panel.

To change the trip displayed on the Cockpit Panel, select either "since last charge," "TRIP A," or "TRIP B".

There are two trip range memories available, TRIP A and TRIP B. To reset either trip memory, press the RESET button next to the TRIP listing.

---

# Pilot Panel

## Extending and Retracting the Pilot Panel

---

The Pilot Panel retracts to reveal extra storage.

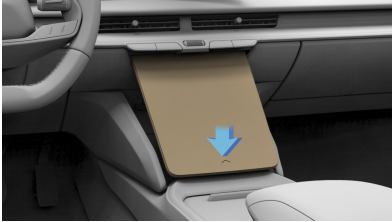

Touch and hold the arrow at the base of the Pilot Panel. The panel will retract into the dash, revealing the storage space. Touch the arrow again to extend the Pilot Panel.

# Center Cockpit Panel

## Center Cockpit Panel - Overview

*Note:* The illustration below is for demonstration purposes. The information in your vehicle display may have differences depending upon the current software version and market region.



1. Trip information area
2. Charge meter, see [Charge and Power Meter](#) on page 64
3. Power meter, see [Charge and Power Meter](#) on page 64
4. Turn signal indicators, see [Turn Signals](#) on page 74
5. Navigation widget
6. Odometer
7. Speedometer
8. Battery State of Charge indicator, see [Battery State of Charge Indicator](#) on page 64
9. Gear selection indicator, see [Using the Drive Selector](#) on page 69
10. Warning indicator

The following icons may be displayed on the Center Cockpit Panel to alert you to which features are operating or if there are any systems with faults.

For further information, refer to the relevant section in this manual.



Anti-lock Braking System (ABS) disabled or system fault detected

---



Tire Pressure Management System (TPMS) low tire pressure (solid) or system fault detected (flashing)

---



Low washer fluid level

---



Low coolant level

---



Headlight leveling fault detected

---



Exterior light fault detected

---



Rear fog light active

---



Side/Position lights active

---



Low beam headlights active

---



High beam headlights active



Low high-voltage battery State of Charge (SoC)



12V battery charging system fault detected



High temperature detected for high-voltage battery



Low temperature detected for high-voltage battery



Brake System Warning. Call Lucid Service Center.



Brake System Warning. Call Lucid Service Center.



Excessive brake wear detected



Left turn signal active





Right turn signal active



Highway Assist active



Airbag system fault detected



Lane Departure Protection disabled or system fault detected



Lucid Stability Control system is in a reduced state



Collision Protection disabled



Collision Protection fault detected



Drive mode enabled



Vehicle hold is currently active and holding vehicle



Parking brake applied

---



Parking brake fault detected



Door open or ajar



Seat belt not fastened



System warning



System alert



Driver's monitoring camera cannot detect their face



Drowsy Driver alert



Lucid Stability Control operating when flashing. If indicator stays solid, a fault is detected.



Limited Power Mode active



Steering system fault detected

The following warning indicators are applicable to Canada only:



Brake System Warning; Stop the vehicle. Call Lucid Service Center.



Brake System Warning. Call Lucid Service Center.



Excessive brake wear detected



Parking brake fault detected



Parking Brake applied



High Beam Assist applied

---



High Beam Assist fault detected

If the high-voltage drive system detects a critical problem with the battery or the drive motors, a red warning message and instructions will be displayed in the center of the Cockpit Panel, accompanied by audible alerts.

Other Cockpit Panel indicators related to the battery or drive motors are accompanied by warnings, information, and/or instructions displayed in the left widget.



High temperature detected for high-voltage battery

---



Low temperature detected for high-voltage battery

---



12V battery charging system fault detected

---



System alert: A detected problem requires your attention and caution.

---



System warning: For safety, a detected problem requires immediate attention/action.

- **WARNING:** If any of these notifications are displayed while driving, there may be a reduction in performance until the issue is resolved.

The meter that arcs over the speedometer shows the current power use of the vehicle, and whether the vehicle is using or generating power.

If the vehicle is using power, then the meter fills to the right. If the vehicle is generating power, then the meter fills to the left.

The battery icon below the speedometer shows the current State of Charge (SoC) level for the high-voltage battery pack, along with an estimated vehicle range based on the remaining charge.

As you drive the vehicle or operate any of its features, the battery pack's charge will be depleted, and the icon will reflect the change in SoC and vehicle range. As the charge level is drawn down, the Cockpit Panel displays notifications. See [Preserving battery pack health](#).



When the remaining battery pack charge falls below 50mi/80km, a yellow low battery indicator displays on the Cockpit Panel.

*Note:* Lucid recommends that if the SoC falls below 50mi/80km, consider finding somewhere you can charge the vehicle. Remember the vehicle range is only an estimate, and the actual drivable distance can vary according to environmental and terrain conditions.

# Starting and Powering Off

## Starting

Your vehicle does not require a key to be turned or a button to be pressed to start it. If a paired key fob, valet card or phone is recognized when the driver's door is opened, the Cockpit and Pilot panels will power on indicating the vehicle is ready to operate.

### Accessory mode

When you first get into the vehicle and sit in the driver's seat, the vehicle will be in Accessory mode. The Cockpit and Pilot panels will both power On.

The Cockpit Panel shows you the current vehicle status, e.g. door open and battery charge level.

In Accessory mode, all the electrical features and controls can be operated but the vehicle cannot be driven.

*Note:* If you try to select a gear in Accessory mode without pressing the brake pedal, the message Push Brake will be displayed.

### Drive Mode

While sitting in the driver's seat, press the brake pedal to put the car in Drive Mode. The vehicle searches for a recognized key fob or mobile key. If a known device is detected, the vehicle is allowed to start. If no known device is detected, a message displays on the Cockpit Panel.

If a valet card is used to open the door, the driver will be prompted to enter a PIN code before allowing to drive. See [Starting](#) on page 65.

*Note:* You cannot put the vehicle into Drive Mode while a charging cable is connected.

The display on the Cockpit Panel will change to show the Speedometer, Power meter, and the PRND display. The indicator lights briefly illuminate during system check.



The Ready to Drive icon is displayed on the Center Cockpit Panel.

Select a gear to drive the vehicle. See [Using the Drive Selector](#) on page 69.

*Note:* The Drive Mode enabled icon disappears when the vehicle is in motion.

### Key fob not detected

If no recognized key fob is detected inside the vehicle when you attempt to shift out of Park, a message appears on the Cockpit Panel asking the driver to enter a PIN before the vehicle can be put into Drive.

If the vehicle still fails to start, try using another key fob or the Valet card. If the vehicle still can't be started, please contact **Lucid**.

*Note:* Several factors impact whether the key fob is detected. These include a low key fob battery, radio frequency interference from other devices, and objects between the key and receiver.

### Key no longer detected

If your vehicle is in Drive mode and the vehicle can no longer detect the key fob inside the vehicle, a warning message will be displayed on the Cockpit Panel.

*Note:* Always make sure you have the key fob with you before making a journey, as you will be unable to restart the vehicle once it has powered off.

## Powering Off

When you have finished driving and selected P (Park), the parking brake will engage and all systems will remain operational.

*Note:* If the vehicle is not in 'Park' and is stationary, when the driver door is opened, the vehicle will automatically shift to P (Park).



If the key fob is still detected in the area, and the brake pedal has not been pressed, the vehicle will power down after 15 minutes. If the key fob is not detected in the area, the vehicle will power down.

---

# Steering Wheel

## Adjusting the Steering Wheel Position

---

Use the Pilot Panel to adjust steering wheel position by touching  > .

Press the Up/Down/In/Out arrows to adjust. Press RESTORE to return to the previous position, or press SAVE TO PROFILE to save position to the current User Profile.

Press  to close.

## Steering Feel and Sensitivity

---

The feel and sensitivity of the steering system is determined by the current driving mode selected for the vehicle. See [Drive Modes](#).



1. For information about Left Controls, please see [Steering Wheel - Left Controls](#) on page 68
2. Controls the volume for all media, audio, and phone calls
  - Push up to raise volume
  - Push down to lower volume
  - Press center button (<1 second) to play/pause, take an incoming call, or mute the microphone during a call
  - Long press (>1 second) center button to end an active call or reject an incoming call
3. Skip to the previous song or station
4. Skip to the next song or station
5. Press to use voice commands



To sound the horn, press the center pad on the steering wheel



1. Cancel cruise control.

Set and adjust Adaptive Cruise Control (ACC) cruising speed:

- Press the side of the switch to set the desired cruising speed
  - Press and hold the side of the switch to resume cruising at a previously set speed
  - Push up once: Speed increase by 5 mph (km/h)
  - Push up and hold: Speed increase by 10 mph (km/h)
  - Push down once: Speed decrease by 5 mph (km/h)
  - Push down and hold: Speed decrease by 10 mph (km/h)
2. Press to increase the distance to the vehicle in front when ACC is active.
  3. Press to decrease the distance to the vehicle in front when ACC is active.

Horn



# Drive Selector

## Using the Drive Selector

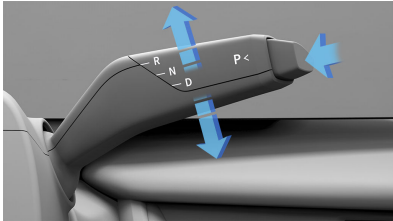

With the vehicle in P Park or N Neutral, move the right steering column lever up or down to select Reverse or Drive. The Center Cockpit Panel shows the current selection. When in Park, you must also press the brake pedal before selecting D Drive or R Reverse.

*Note:* If you try to make a selection that is prohibited due to the current vehicle speed, a chime will sound and a message will be displayed on the Cockpit Panel.

### R (Reverse)

Push the lever up and release to select R. Reverse can only be selected when the vehicle is stationary or its forward speed is less than 5 mph (8 km/h).

### N (Neutral)

Allows the vehicle to roll freely unless the brakes are applied. Push the lever up or down from the currently selected gear and release to select N.

### D (Drive)

Push the lever down and release to select D. You can only select Drive when the vehicle is stationary or its speed is less than 5 mph (8 km/h) in reverse.

### P (Park)

When P is selected, the parking brake is automatically applied. With the vehicle stationary, press the end of the gear selector to select Park.



*Note:* P is automatically engaged when you connect a charging cable to the charging port. This is to prevent the vehicle from moving while still connected.

*Note:* If the vehicle is in D or R, P will automatically be selected if you open the driver's door and get up from the driver's seat.

- **WARNING:** It is the responsibility of the driver to always ensure the vehicle is in Park before exiting. Never rely on the vehicle to automatically shift into Park.

## Vehicle Creep

- **WARNING:** Do not rely on Creep to keep your vehicle stationary on a hill. To avoid collisions or property damage, you should always apply the brake to remain stopped when on a hill.

Creep is enabled or disabled via the Pilot Panel. Select  >  Vehicle > Drive Settings.

When Creep is On, releasing the brake pedal and tapping the accelerator causes the vehicle to slowly move forward in D (Drive), or backward in R (Reverse). On steeper slopes or hills it may be necessary to apply the accelerator to move the vehicle forward.

When Creep is Off, the vehicle will either be in a free-rolling state or hold stationary, depending on the selected drive settings.

# Drive Modes

## Using Neutral

1. To shift out of park unlock the car with either the keyfob, the nfc card, a paired phone, or the phone app with correct credentials.
2. Once the car is unlocked and powered on, you can open the driver door and shift to neutral by pressing the brake pedal and operating the shift lever. The park brake will disengage, and the vehicle will be ready to be pushed or pulled.
3. If the electrical system of the vehicle is dead where the vehicle does not wake up and unlock when asked for, the operator needs to connect a 12v jump-start battery to the jump-start terminal so that operations A and B can be conducted.

## Drive Modes

Your vehicle can be set to your preferred driving and regenerative braking modes. You can opt for more comfortable and less responsive vehicle controls in order to increase energy efficiency.

Use the Pilot Panel to select Drive Mode by touching .

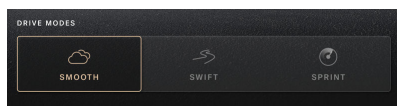

### Smooth

Smooth mode offers a relaxed and range-focused driving experience. When activated, the steering, braking and suspension systems will be optimized for comfort, and the powertrain response will be smoothed.

### Swift

Swift mode is designed for spirited driving. When activated, steering, braking and

suspension systems will be optimized for a dynamic driving experience. Powertrain responsiveness, and available power and torque, will be increased. Upon powering the vehicle off and on again, the drive mode will return to Smooth.

### Sprint

- **WARNING:** It is recommended that this mode is used only by advanced and skilled drivers, in suitable environments, and with Lucid-specification summer tires installed.

Sprint Mode enables the maximum power and torque of your vehicle, designed for short duration bursts of intense performance. Steering, braking and suspension systems are optimized for stability and control. To use this mode, you must select it and agree to a disclaimer. Upon powering the vehicle off and on again, the drive mode will return to Smooth, and the disclaimer requirement will reset.

*Note:* This mode cannot be selected if the vehicle is using the guest profile. Please login to enable this mode.

### Limited Power Mode

- **CAUTION:** It is recommended that when driving in Limited Power Mode you should travel in the lane of slower moving traffic and be prepared to stop.

Limited Power Mode automatically activates if a fault is detected by the vehicle's drive controller to protect the powertrain. When activated, vehicle power is reduced, speed and performance are limited.



When Limited Power Mode is active, an indicator will be displayed on the Cockpit Panel.

If Limited Power Mode activates while you are driving, do not panic! Pull off the road when it is safe to do so and call roadside assistance.

- **CAUTION:** Limited Power Mode should NOT be used for sustained operation of the vehicle.



---

# Mirrors

## Adjusting the Exterior Side Mirror Position

---

- **WARNING:** Dependent upon the type of mirror glass fitted to your vehicle, distances may be difficult to judge accurately. Objects viewed in the mirror may be closer than they appear.



Use the Pilot Panel to adjust side mirror position by touching  > .

1. Press the LEFT or RIGHT button to select the mirror.
2. Press the Up/Down/In/Out arrows to adjust.

Once adjusted, press RESTORE to return to the previous position or press SAVE TO PROFILE to save to the current User Profile.

Press  to close.

### Folding and unfolding

To manually fold/unfold the exterior side mirrors via the Pilot Panel, press  > .

### Heating and defrosting

The exterior side mirror defrost feature activates when the rear defrost button is activated. See [Defrost](#).

## Interior Rear View Mirror

---



Manually adjust the position of the rear view mirror for the desired view behind you.

The mirror will automatically dim in proportion to the level of glare detected from a following vehicle's headlights.

*Note:* This feature is disabled when the vehicle is in R (Reverse) to provide an unimpeded view in reverse.

# Exterior Lights

## Exterior Lights Control

The exterior vehicle lights are controlled using the left lever on the steering column and the left cockpit panel.



Touch the corresponding icon to operate the exterior lights as follows:



AUTO lights

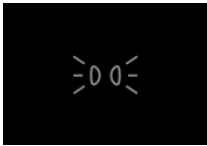

Position lights

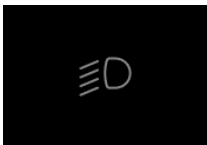

Low beam headlights

### AUTO lights

The low beam headlights will automatically switch On when the ambient light falls below a pre-defined level. The front and rear position

lights, as well as the license plate lights, are always on.

The headlights will switch Off when the ambient light rises above that level.

*Note:* The lights will switch On whenever the windshield wipers are operating.

### Position lights



The position (side marker) lights indicator is displayed on the Cockpit Panel whenever the position lights are On.

### Low beams



The low beam indicator is displayed on the Cockpit Panel whenever the low beams are On.

### Daytime running lights

*Note:* The functionality and operation of daytime running lights will vary according to market requirements.

In regions that require the vehicle's lights to be On even during the day, the daytime running lights will automatically turn ON when the vehicle is powered, and they will turn OFF if the headlamps or the fog lights are ON.

### Light failure



If the vehicle detects that an exterior light is not working the light failure indicator will be displayed on the Cockpit Panel. This will be accompanied by a message as to which light function has failed. In the case of a failure of a turn indicator only: in addition to the aforementioned message, the frequency of the tell-tale indicator (on the ICC) and audio chime will double, to help alert the driver that the lamp is not operating normally.

### High Beam Headlights

*Note:* The headlight high beams will only operate if the low beams are on, except when used for temporary flashing.

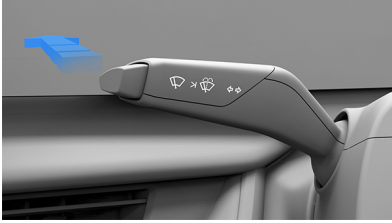

To turn on the high beam headlights, push the left steering column lever away from you. To cancel, pull the lever towards you.



The high beam indicator displays on the Instrument Cluster whenever high beams are On.

### Headlight High Beam Flash

You can flash the headlight high beams even if the low beams are OFF by pulling the lever towards you and releasing it.

See [High Beam Assist](#) on page 103 for more information on High Beam assistance.

### Rear Fog Light

*Note:* Regulations concerning the use of fog lights vary by country.

The rear fog light is considerably brighter than ordinary tail lights and should only be used to help other road users see your vehicle in low-visibility conditions such as fog or heavy snowfall.



Use the left Cockpit Panel to turn the rear fog lamp On or Off.



The rear fog light indicator is displayed on the Cockpit Panel whenever the rear fog light is On.

*Note:* The rear fog light is automatically turned Off each time the vehicle is powered On, and will need to manually turned On if required.

*Note:* The rear fog lights can be turned on only when the headlights are manually turned on or in AUTO mode at night.

### Turn Signals

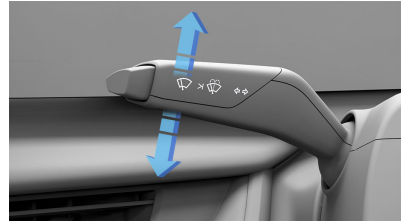

The turn signals are activated by moving the left steering column lever down to operate the left turn signals, or up to operate the right turn signals. If you lightly push the stalk up or down, it will activate the turn signal only temporarily, for three flashes.

The turn signals will continue to operate until automatically canceled by the steering wheel, or by lightly pushing the steering column lever in the opposite direction.

*Note:* Pushing the steering column lever all the way in the opposite direction switches the turn signals to the opposite direction instead of being canceled.



When a turn signal is activated, the corresponding turn signal indicator is displayed on the Cockpit Panel.

You will also hear a clicking sound when the turn signal is operating.

### Lane changes

To signal a lane change, momentarily hold the lever up or down against the spring pressure and then release; the turn signals will flash three times to indicate a lane change.

---

## Hazard Warning Lights

---

*Note:* The hazard warning lights can be operated even when a key fob is not in the vehicle.



To turn on the hazard warning lights, press the switch located on the overhead console. All turn signals will flash along with the turn signal indicators on the Center Cockpit Panel.

Press the switch again to switch off the hazard warning lights.

*Note:* You should only use hazard warning lights in an emergency to warn other road users of a breakdown or other potential danger. Remember to switch off when the hazardous situation has been resolved.

### **After a collision**

If you are involved in a collision that causes the airbags to be deployed, the hazard warning lights will automatically switch on.



# Interior Lights

## Interior Lights

The interior lights automatically switch On when a vehicle door is opened, and Off when all doors are closed.

### Front seats



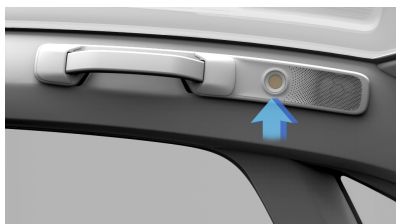

To turn the front interior light On or Off, use the switch located on the overhead console or touch either light individually.

### Rear seats



To turn either of the two rear passenger reading lights On or Off, press the center of the lamp lens.

## Ambient Lighting

Ambient lighting illuminates the footwells, cup holders, and accent areas with your choice of colored lighting. To customize ambient lighting, press  >  THEMES on the Pilot Panel.

*Note:* If enabled, the ambient lights come on whenever the vehicle is On. If ambient lighting

is turned off, it will remain off until you turn it back on.

Tap an ambient lighting theme to select. If desired, use the center color wheel to customize brightness. The center section of the color wheel has an ambient lighting on/off switch. If turned off, the touch interface disappears until you switch ambient lighting back on.

# Wipers and Washers

## Wipers

- **CAUTION:** Do not activate the wipers if they are frozen to the windshield; this could damage the wiper blades and the wiper motor.
- **CAUTION:** Do not activate the wipers on a dry windshield; this could damage or cause unnecessary wear to the wiper blades.

Control wipers using the icons in the left Cockpit Panel as follows:

### OFF

In AUTO, the vehicle's rain sensor detects whether or not it is raining and activates the wipers as required. The sensitivity of the wiper activation is selected by the LO or HI icons.

### LOW speed continuous wipe

### HIGH speed continuous wipe

**ICE SCRAPE** When there is Ice/Snow build-up on the windshield, you may activate the wiper ice-scraping feature to assist in the quick de-icing of the windshield. This feature can only be activated when the vehicle is in PARK, and sufficient washer fluid is in the washer reservoir.

**Note:** Intervals between wipes reduce as the vehicle's speed increases.

## Washers

- **WARNING:** Operating the washers in cold weather could cause the fluid to freeze on the windshield, obscuring your vision and causing a collision. Use the windshield heater to warm the windshield to reduce the possibility of the fluid freezing.

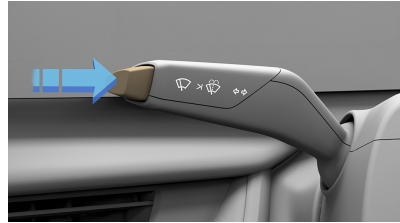

The left steering column stalk button is used for wiper controls. To get a single dry wipe, press the button to the first detent once, or press and hold at the first detent for multiple dry wipes. To spray the washer fluid press the button to the second detent or press and hold at the second detent for multiple wash-wipe cycles.

The wipers will operate with washer. Release the button to stop the washer. After the button is released, the wipers will make several extra sweeps.



If the fluid level in the washer reservoir is low, the warning indicator will be displayed on the Cockpit Panel.

- **CAUTION:** Do not operate the washers when the fluid reservoir is empty or frozen. This can cause the washer pump to overheat and fail.

# Brakes

## Braking Systems

- **WARNING:** It is critical to occupant safety that your braking systems are always functioning properly. If you experience any braking issues or receive any fault messages regarding the braking system, contact a Lucid Service Center immediately.
- **WARNING:** Driving through heavy rain or water can have a temporary adverse effect on braking efficiency.
- **CAUTION:** Do not rest your foot on the brake pedal while the vehicle is in motion unless you are applying the brakes. Resting your foot on the brake pedal can cause premature brake wear.

The foot pedal hydraulically-operated brakes are electrically boosted, but only when the vehicle is On. If the vehicle loses power when driving, you will need to apply more force on the brake pedal and you will experience longer stopping distances.



If the brake fluid level in the reservoir is low, a red brake indicator and a notification message will be displayed on the Cockpit Panel.

See [Checking Brake Fluid](#) on page 157.



If the yellow brake indicator displays on the Cockpit Panel, a brake system fault has been detected.

Contact a **Lucid Service Center** as soon as possible.

**Note:** It's normal for new brakes to produce minor noises during a break-in period, during which time the brake pad and rotor optimize their surface contact area and friction force. A typical break-in period is approximately 20-25 stops from 35mph (56 kph) or higher.

### Anti-Lock Braking System (ABS)

- **WARNING:** Always maintain an appropriate distance from the vehicle in front. ABS cannot overcome the

physical limitations of trying to stop the vehicle in too short a distance.

- **WARNING:** The braking distance on road surfaces that are wet, slippery or loose is always increased; even for vehicles equipped with ABS.
- **WARNING:** Always drive with due care and attention to your surroundings and road conditions. ABS will not correct driver errors.

Your vehicle is equipped with an Anti-lock Braking System (ABS) that helps prevent the wheels from locking during hard braking or when braking on roads with reduced grip.

During braking, the ABS monitors the speed of each wheel and varies the brake fluid pressure at each wheel to prevent the wheels from locking. This system helps maintain steering ability during maximum brake application.

When ABS activates, you may experience the following conditions:

- Pulsations in the brake pedal
- A slight drop of the brake pedal
- Clicking or grinding noises
- ABS warning indicator flickering on and off as the system activates

These conditions demonstrate that ABS is operating and are not a cause for concern. Maintain a firm and steady pressure on the brake pedal while experiencing the pulsation.

### Emergency braking

- **WARNING:** Do not pump the brake pedal. This interrupts the operation of the ABS system and increases your stopping distance, which could lead to a collision.

In an emergency, fully press the brake pedal even when the road surface is slippery.

## ABS warning indicator



The ABS indicator displays on the Cockpit Panel, along with a notification message. If illuminated, the ABS is disabled. Contact a **Lucid**

**Service Center** as soon as possible to have the fault repaired.

- **CAUTION:** Even when ABS is disabled, the pedal-operated braking system remains operational. Be aware that braking distances may increase and wheels may lock under heavy braking.

### Regenerative Braking

- **WARNING:** If driving the vehicle in reduced traction conditions (that is, icy or snowy conditions), the use of High regenerative braking level may cause traction control to operate more frequently. Lucid recommends switching to Standard level when driving in such conditions.

Whenever the vehicle is moving and your foot is off the accelerator, regenerative braking slows the vehicle and feeds energy back to the high-voltage battery.

While you should still use the brake pedal whenever needed to stop safely, you can take advantage of regenerative braking by anticipating your stops and reducing accelerator pedal position.

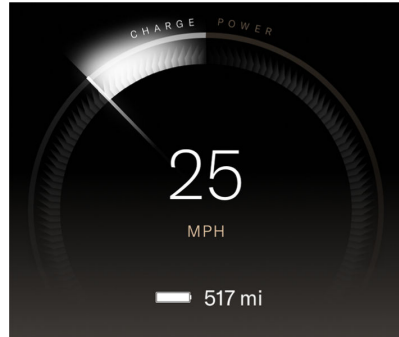

**Note:** If regenerative braking is aggressively slowing your vehicle (such as when your foot is completely off the accelerator pedal at highway speeds), the brake lights turn on to alert others that you are slowing down.



During regenerative braking, the charge/power meter that arcs over the speedometer shows the current amount of energy being generated and fed back to the high-voltage battery.

The amount of generated energy being fed back to the high-voltage battery can vary depending on the current state of the battery and the regenerative braking setting being used. For example, regenerative braking may be limited if the battery is extremely hot or cold or if the battery is already charged to its maximum allowable level.

## Regenerative braking settings

On the Pilot Panel, press  >  Vehicle > Drive Settings, then press to select between two levels of Regenerative Braking:

- **Standard** - Provides the standard amount of regenerative braking.  
  
When you release the accelerator, the vehicle takes longer to slow down and coasts further than if set to High.
- **High** - Provides the maximum amount of regenerative braking.



When you release the accelerator, the vehicle slows down faster, reducing the need to use the brakes.

**Note:** Should regenerative braking levels be limited, you'll notice a difference in driving behavior. You may need to apply the brake pedal more frequently in these conditions.

Vehicle Hold controls brake settings, and can keep your vehicle stopped even when your foot is not on the brake pedal.

When set to HOLD, the vehicle remains stationary after a stop. The brakes hold until the driver presses the accelerator pedal again. If set to ROLL, the car rolls freely after releasing the accelerator.

To configure, use the Pilot Panel and touch

 >  Vehicle > Drive Settings, then select the desired mode.

*Note:* The default setting is HOLD, and can only be changed when the vehicle is in P (Park). The setting saves to your User Profile.

*Note:* Vehicle Hold disengages if the driver shifts into N (Neutral) or presses and releases the brake pedal.

*Note:* Vehicle Hold will disengage and shift into P (Park) in any of the following instances:

- Hold has been braking for approximately 10 minutes.
- The system detects that the driver has exited the vehicle.

#### Parking Brake

- **CAUTION:** In the unlikely event that your vehicle loses electrical power, you will not be able to select another gear and therefore will be unable to release the parking brake. Contact a **Lucid Service Center** for assistance.

The parking brake operates on the rear wheels only, and is independently controlled of the pedal-operated brake system.

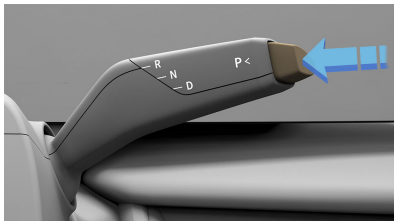

The parking brake automatically applies when P (Park) is selected, and releases when any other gear is selected. It is also engaged by certain systems when a time limit is reached. See [Vehicle Hold](#) on page 80.



The red parking brake indicator is displayed on the Cockpit Panel when the parking brake is engaged.

A flashing indicator signals either operating with a fault, or a parking brake stuck in operation.



If the indicator is amber, a fault has been detected and the parking brake may not be applied when the vehicle is in P (Park). This will be accompanied by a notification on the Cockpit Panel. Contact a **Lucid Service Center** to have the fault repaired.

#### Emergency use

- **CAUTION:** Driving the vehicle with the parking brake applied, or repeated use of the parking brake to slow the vehicle, may cause serious damage to the brake system.

In an emergency, pressing and holding the P (Park) button decelerates the vehicle to a low speed using the service brakes, then applies the parking brake.

#### Parking on a slope

- **WARNING:** In snowy or icy conditions, the rear wheels may not have sufficient traction to prevent the vehicle from sliding when parked on a slope. You are always responsible for parking safely.
- **WARNING:** If parking on too steep a grade for the parking brake to securely hold the vehicle, the vehicle will give audible and visual warnings. Drive to a less steep area and re-park.

As an added precaution:

- If your vehicle is parked on a hill and facing uphill, turn the steering wheel so the front wheels are pointing away from the curb.
- If your vehicle is parked on a hill and facing downhill, turn the steering wheel

so the front wheels are pointing towards the curb.

#### Brake Pad Wear

---

- **WARNING:** Neglecting to replace worn brake pads can damage the brake rotors, reduce the vehicle's braking efficiency, and increase the distance needed to stop the car.

The brake pads installed on your vehicle are equipped with wear indicators, which will cause the vehicle to display warning messages when the brake pads are nearing end of life. To replace the brake pads, contact authorized Lucid Motors Service Center.



If the red brake wear indicator displays on the Cockpit Panel, the system has detected excessive brake wear. Contact a **Lucid Service**

**Center** as soon as possible to have the brakes inspected.

# Lucid Stability Control

## Lucid Stability Control

- **WARNING:** No electronic system can remove the need for safe driving practices. Although the Lucid Stability Control system can help to maintain control of the vehicle under certain driving conditions, it cannot prevent any accident which may occur due to unforeseen road conditions (e.g. black ice, standing water, etc.) or result from careless/dangerous driving techniques.

The **Lucid Stability Control** system uses multiple sensors to monitor driver inputs and vehicle motion. Under certain driving conditions, the system helps to perform the following functions:

- Controls brake pressure to reduce wheel slip on one slipping drive wheel so power is transferred to a drive wheel on the same axle that is not slipping.
- Controls brake pressure and traction motor output to reduce drive wheel slip.



Controls brake pressure at individual wheels and traction motor output to help the driver maintain control of the vehicle in the following conditions:

- Under-steering, sometimes called "washout." When the front wheels are turned and the vehicle does not respond but continues straight, causing the front tires to lose traction.
- Over-steering, sometimes called "fishtailing." When the rear tire loses traction during a turn and causes the rear of the car to swing out further than intended.



If the **Lucid Stability Control** system activates while driving, the indicator will flash on the Center Cockpit Panel. If a fault is detected, the indicator remains on.

## Lucid Stability Control settings

On the Pilot Panel, press  >  Vehicle > Drive Settings, then press to select between three levels of **Lucid Stability Control**:

- Full - This setting is recommended for most driving conditions.
- Partial - Provides a more dynamic driving experience. Not available in "Smooth" mode.
- Off - Disabling stability control significantly reduces traction control and should only be disabled by advanced drivers on closed courses. Not available in "Smooth" mode.

*Note:* You'll be prompted for confirmation when turning off **Lucid Stability Control**.



If the Lucid Stability Control system is disabled, the indicator will illuminate on the Cockpit Panel throughout the drive cycle.

*Note:* This setting defaults to FULL for each new key cycle.

# Getting Maximum Range

## Driving Tips to Maximize Range

---

- Remove any unnecessary cargo to reduce vehicle load weight.
- Ensure your tires are maintained at their specified inflation pressures. See [Maintaining Tire Pressures](#) on page 177.
- Keep all windows closed when possible to reduce drag.
- Avoid abrupt and/or frequent acceleration. Try to maintain an even speed.
- When it is safe to do so, use one pedal driving techniques to gradually slow the vehicle using regenerative braking rather than friction braking. See [Braking Systems](#) on page 78.
- Switch into Smooth mode. See [Drive Modes](#) on page 70.
- Limit the use of the heating and air conditioning controls when possible. Using seat heaters to keep warm is a more energy-efficient alternative than heating the entire cabin.



---

# Heating, Ventilation Air Conditioning

## Temperature Control

---

Cabin heating, ventilation, and air conditioning is divided into four zones: The driver and passenger side in front, and the left and right sides in the rear.

These zones can be adjusted simultaneously or individually by using the Pilot Panel, the Rear Center Console Display, or the buttons on the dash.

### Pilot Panel climate controls

On the bottom of the Pilot Panel, press . Press FRONT or REAR to access the controls for those zones. Use the sliding bars to adjust temperature and fan speed for that zone. Slide the bar all the way down to turn the fan Off.

 This turns all controls for all four zones On or Off. For REAR controls, this turns all controls for the two rear zones On or Off.

---

 Press to turn air conditioning On or Off.

---

Press to switch between air circulation modes. Cabin air can be continuously recirculated, or a blend of fresh and cool air can be drawn from outside.

 *Note:* Avoid recirculating cool interior air for extended periods, as this can fog up the windows.

---

 Front windshield defrost. See [Windshield Defrost](#).

---

 Rear defrost and side-view mirrors. See [Rear Window Defrost](#).

---

 Activating this feature maintains the current cabin temperature after exiting the vehicle for 45 minutes.

*Note:* You will be prompted to confirm your selection.

*Note:* This feature automatically disables when the battery drops below 50 miles (80 kilometers) of range.

---

 Press to open the Settings menu. From this menu, auto-conditioning the seats and steering wheel can be toggled On or Off.

---

 When this feature is On, zone fan speed and vent modes are both automated by the system based on the set temperature.

---

 When SYNC is activated, all climate control states are synchronized with the driver zone (temperature value, fan speed value, and vent modes).

*Note:* If a passenger adjusts a control while SYNC is On, this turns SYNC Off. The control states for the remaining zones stay as they were previously set while in SYNC.

---

 Press an icon to turn the fan for that area On or Off. Multiple areas can be selected simultaneously.

---

### Front temperature control buttons

Buttons on the dash can be used to adjust the temperature and fan speed for the driver and front passenger. Move a button up or down once to change the temperature or fan speed by  $\pm 1$  increment. Press and hold the toggle to raise or lower by multiple increments.

When using the temperature control buttons, the right Cockpit Panel opens a small Peek window along the bottom of the display. This window displays the current temperature and fan settings, and updates according to the control interactions. Changed settings are highlighted.

*Note:* The Peek window automatically disappears after a few seconds of inactivity. Touch or swipe anywhere on the Peek window to dismiss it sooner.

### Rear Center Console Display

From the main menu, select Climate to access the controls for the rear zones. To return to the main menu, press on the bottom bar and swipe up.

Press an arrow once to change the temperature or fan speed by  $\pm 1$  increment. Press and hold adjust by multiple increments.

*Note:* When the system does not detect any passengers in the rear seats, climate controls are automatically turned Off.

## Remote Climate

Remote Climate is available within the **Lucid** mobile app, allowing you to remotely set the cabin temperature or windshield defrosting controls.

*Note:* When Remote Climate is activated, any changes to the temperature controls via the Pilot Panel will cancel the feature.

Defrost

---

### Windshield defrost



To defrost the windshield, press the icon on the left Cockpit Panel or from the  screen on the Pilot Panel. The icon will highlight when activated.

Once pressed, heat and fan speed will switch to high settings, and air flow will be directed through the vents at the base of the windshield.

*Note:* When front defrost is activated, any changes to the temperature controls via the Pilot Panel will cancel the feature.

### Rear window defrost



To activate the rear window defroster, press the icon on the left Cockpit Panel or from the  screen on the Pilot Panel. The icon will highlight when activated.

After approximately 15 minutes, the defroster will automatically turn off.

# Interior Equipment

## Sun Visors

To use a sun visor, fold it down from its stowed position. Sun visors can also pivot towards the side window by releasing it from the retaining clip.

**Note:** Make sure the sun visor is secured by the retaining clip when returning it to its stowed position.

Both sun visors have a covered mirror. Raise the cover to use the mirror; an integrated light automatically turns On. The light turns Off when the cover is closed.

### Sun visor battery replacement

- **WARNING:** Each sun visor contains three coin/button type batteries. These batteries contain toxic and corrosive substances. Batteries are a chemical burn hazard and should never be ingested. If a battery is swallowed, it can cause serious internal burns and may even lead to death.
  - Keep new and used batteries out of the reach of children.
  - If you think batteries may have been swallowed or placed inside any part of the body, seek immediate medical attention.

Due to the unique design of your vehicle, the sun visors use batteries to power the mirror lights.

**Note:** The batteries have an estimated life of approximately two years based on typical usage.

To replace the batteries:

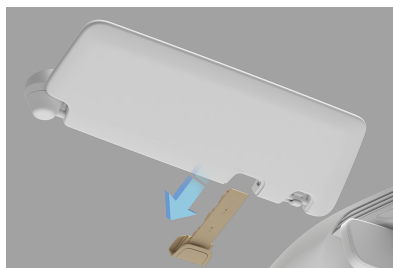

With the sun visor in its stowed position, slide the battery holder towards the front of the vehicle.

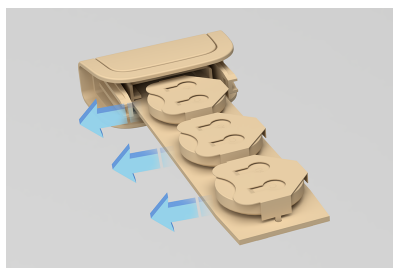

Remove the old batteries.

Install new batteries and avoid touching the flat surfaces of the batteries if possible, as finger marks can reduce battery life. Wipe the batteries clean before installation. Fit the battery with the "+" side facing upwards. Reinstall the battery holder in the sun visor.

**Note:** Always replace all three batteries with new CR2032 batteries.

## Glove Box

The glove box is opened using the Pilot Panel. Select  > GLOVEBOX. To close, push the glove box cover until it latches.

Front Armrest and Storage Compartment

- **WARNING:** Do not operate the vehicle with the storage compartment lid in the open position as this could result in injury in a collision.

Slide the cover to access the front cup holders and storage area.

Pull the release latch and lift up the armrest to access the storage compartment.

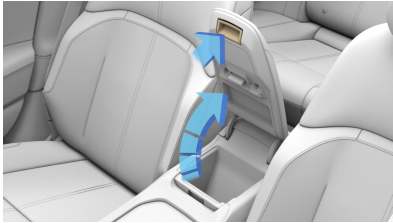

Center Console Storage Compartment



Pull the latch to release the storage compartment cover and allow it to open. Press the cover to close.

Rear Armrest and Storage Compartment

- **WARNING:** The rear armrest must not be used as a seat or a booster cushion for small children. Children must be seated in a seat suitable for their size and weight to reduce the risk of injury in a crash.

Use the latch to pull down the rear center armrest.

Pull up on the lid to access the storage compartment. Close the lid and push the armrest up to close.

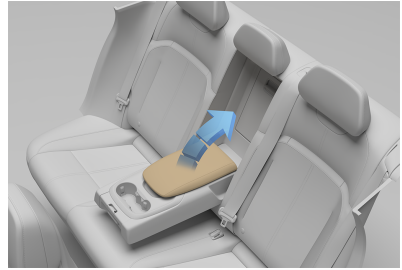

Cup Holders

**Note:** The cup holders have a rubber insert that can be removed to allow them to be cleaned if there is a spillage.

Cup holders are located in the following locations:



Front center console. Slide the cover rearwards to use the cup holder.



---

Rear arm rest. Fold down the rear armrest.

# Accessory Connections

## USB Connections

USB-C ports for charging mobile devices can be found in the following areas:

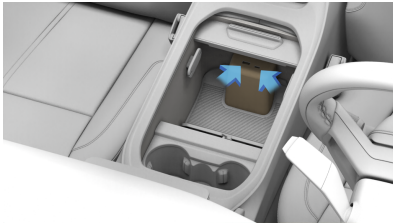

Two in the storage compartment of the front center console.



Two on the rear of the front center console.

*Note:* Do not connect multiple devices to the USB ports using a USB hub. This may overload the USB charging circuit and prevent some devices from charging.

## Wireless Charging



A wireless charging pad is located in the center console storage compartment.

To charge a mobile phone with wireless charging capability, insert the phone in to the left clip with the back of the phone in contact with the side of the storage compartment.

## FCC Notes

This device complies with part 15 of the FCC Rules. Operation is subject to the following two conditions: (1) This device may not cause harmful interference, and (2) this device must accept any interference received, including interference that may cause undesired operation.

Changes or modifications not expressly approved by the party responsible for compliance could void the user's authority to operate the equipment.

This equipment has been tested and found to comply with the limits for a Class B digital device, pursuant to part 15 of the FCC Rules. These limits are designed to provide reasonable protection against harmful interference in a residential installation. This equipment generates, uses and can radiate radio frequency energy and, if not installed and used in accordance with the instructions, may cause harmful interference to radio communications. However, there is no guarantee that interference will not occur in a particular installation. If this equipment does cause harmful interference to radio or television reception, which can be determined by turning the equipment off and on, the

user is encouraged to try to correct the interference by one or more of the following measures:

- Reorient or relocate the receiving antenna.
- Increase the separation between the equipment and receiver.
- Connect the equipment into an outlet on a circuit different from that to which the receiver is connected.
- Consult the dealer or an experienced radio/TV technician for help.

#### 12 Volt Power Socket

- **WARNING:** Close the cover when not in use. If this outlet is mishandled, it may cause an electric shock.
- **CAUTION:** The 12 Volt power socket should not be used with a cigarette lighter. Lighters could potentially cause heat damage to the socket.



Although the power socket is primarily provided for use with the tire repair kit, it can also be used for other accessories requiring up to 15A or a maximum of 180 watts.

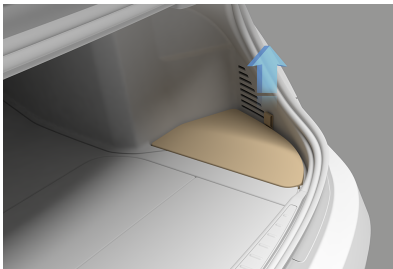

A 12 Volt power socket is located in the trunk. Remove the RH floor panel to access the power socket.

06

# DreamDrive



# About ADAS

## ADAS Limitations

- **WARNING:** This manual does not include all of the situations that might interfere with the proper operation of ADAS components. Never rely on these components to keep you or your occupants safe. It is the driver's responsibility to remain alert and drive safely and responsibly at all times.
- **CAUTION:** Lucid strongly recommends always having your vehicle serviced at a **Lucid Service Center** to ensure all of the vehicle's ADAS components are handled properly. Failure to do so can cause one or more ADAS features to malfunction.
- **CAUTION:** If a fault occurs with any of the ADAS features, contact a Lucid Service Center.

There are numerous factors that can impact the performance of the ADAS components, causing them to be unable to function as intended. These factors include (but are not limited to):

- Poor sensor visibility due to weather conditions (e.g., heavy rain, snow, or fog)
- Bright ambient light (e.g., oncoming headlights or direct sunlight)
- Poor ambient light (e.g., at night or in poorly-lit tunnels)
- If the sensors, cameras, or the camera view areas of the glass canopy become dirty, foggy, damaged, or otherwise obscured
- Interference or obstruction by an object mounted onto the vehicle (such as a bike rack)
- Obstruction caused by applying excessive paint or adhesive products (e.g., wraps, stickers, or rubber coatings) onto the vehicle
- Narrow or winding roads



- A damaged or misaligned bumper
- Interference from other equipment that generates ultrasonic waves
- Extremely hot or cold temperatures
- Lucid Stability Control is partially or completely disabled
- Selecting 'Sprint' driving mode

### Sensor and camera failure

- **CAUTION:** If blockage occurs with an ADAS sensor, attempt to clear the blockage. Remove any objects that may be obstructing the component, or clean off any debris by following the cleaning instructions in this document. See [ADAS Limitations](#). If the warning message persists, contact a Lucid Service Center. If a sensor or camera failure occurs (something other than a blockage that you cannot remedy), contact a Lucid Service Center.



When the system detects that a sensor or camera is blocked, a warning with the location of the blocked component displays on the Cockpit Panel.

When an ADAS component is blocked or faulty, any related features will be unavailable or have degraded performance. On the Pilot Panel under  >  DreamDrive, any relevant settings will be grayed out with a warning message displayed.

## ADAS Features

Your Lucid Air is equipped with Advanced Driver Assistance Systems (ADAS), named Lucid DreamDrive. The following features are available:

## Driving Experience

- Adaptive Cruise Control
- Highway Assist
- Traffic Sign Recognition
- Traffic Drive-Off Alert
- Drowsy Driver Alert
- Distracted Driver Alert

## Supplemental Safety

- Forward Collision Warning
- Automatic Emergency Braking
- Cross Traffic Protection
- Lane Departure Protection
- Blind Spot Warning
- Blind Spot Display

## Parking Experience

- Automatic Park In
- Automatic Park Out
- Surround View Monitoring
- Rear View Monitoring
- Park Distance Warning

The ADAS features are configured using the Pilot Panel. To find out more about each feature, press the 'i' icon next to the feature.

These features are designed to increase vehicle safety and improve driving behavior. You can enable or disable most features individually and (in some cases) adjust operating parameters.

## Driver Responsibility

ADAS systems are designed for comfort, convenience, and to enhance safety. However, these systems are NOT replacements for attentive, responsible driving.

- **WARNING:** As the driver of this vehicle, you are responsible for its safe operation. You must be observant of, and address, any warnings and indications of unsafe conditions caused by the vehicle or external factors.

Brake or steering interventions only take place within defined limits, and may not have time to slow or correct the vehicle enough to avoid a collision. Your complete attention is still required while driving, and you should always be ready to steer the vehicle and apply the brakes when necessary.

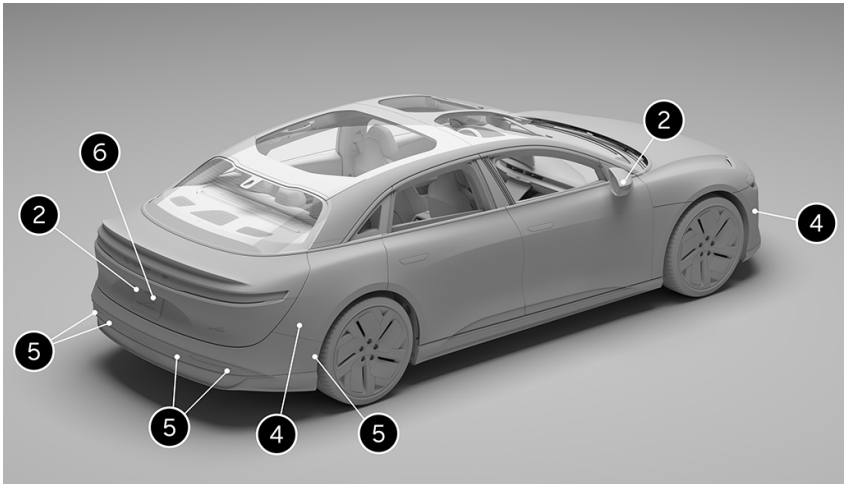
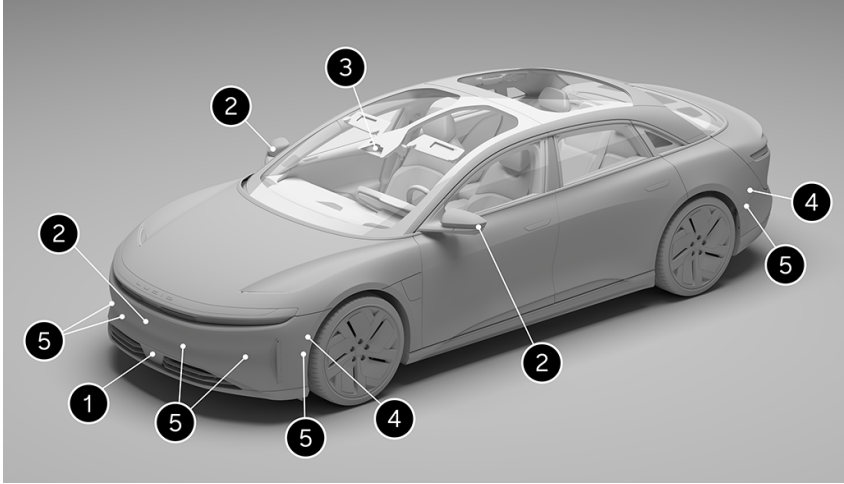

1. Long-Range Radar
2. Surround View Monitoring Cameras, see [Surround View Monitoring](#).
3. Front Multifunction Camera
4. Short-Range Radar
5. Ultrasonic Sensors

6. Rear View Camera, see [Rear View Monitoring](#).

---

# Driving Experience





## Steering Wheel DreamDrive Controls

---



1. Toggle switch
2. DreamDrive activate
3. Gap Setting adjustment
4. Cancel Drive Assist control

### Using DreamDrive

- Press  to access or exit DreamDrive mode.
- Press and hold  to switch between Adaptive Cruise Control and Highway Assist systems (see [Adaptive Cruise Control](#) and [Highway Assist](#)).
- Press the toggle button to engage the feature.
- Push the toggle up/down to adjust the set speed by  $\pm 1$  increment.  
Push and hold the toggle up/down to adjust the set speed by  $\pm 5$  increments.
- Press  to adjust the gap setting (see [Adjusting following distance](#)).
- Press  to cancel Adaptive Cruise Control or Highway Assist.

Adaptive Cruise Control or Highway Assist can be activated when all of the following conditions are met:

- Driver's seat belt is buckled
- All doors are closed
- Vehicle is in D (Drive)
- Brake pedal is released
- Current speed is at least 20 mph (30 km/h)

Adaptive Cruise Control and Highway Assist will automatically disengage and sound an audible alert in any of the following situations:

- Brake pedal is pressed
- Driver's seat belt is unbuckled
- The trunk, the hood, or a door is open
- Gear is shifted out of D (Drive)
- The parking brake is applied (see [Parking Brake](#))
- Vehicle speed goes above the maximum threshold of 90 mph (150 km/h)
- The tires lose traction
- Automatic Emergency Braking is activated (see [Automatic Emergency Braking](#))
- A system feature fails (such as a powertrain or sensor failure)
- Front camera is blocked  
*Note:* If the system notes that the front camera is blocked, try activating the wipers. See [Wipers](#).
- Brake temperature is too high

Adaptive Cruise Control and Highway Assist systems, even under optimal conditions, are not a substitute for safe driving. See [ADAS Limitations](#) for details.

- **WARNING:** Adaptive Cruise Control is designed for your driving comfort and convenience and is not a collision warning or avoidance system. It is your responsibility to stay alert, drive safely, and be in control of the vehicle at all times. Never depend on Adaptive Cruise Control to adequately slow down the vehicle. Watch the road in front of you and be prepared to take corrective action at all times. Failure to do so can result in serious injury or death.
- **WARNING:** Never depend on Adaptive Cruise Control to brake for pedestrians, animals, or other objects. Always watch the road and be prepared to take corrective action. Failure to do so can result in serious injury or death.
- **WARNING:** Do not use Adaptive Cruise Control on city streets or on roads where traffic conditions are constantly changing.
- **WARNING:** Adaptive Cruise Control may not detect or brake for narrow vehicles such as bicycles or motorcycles.
- **WARNING:** Adaptive Cruise Control may not detect stationary or slow-moving vehicles below 6 mph (10 km/h).
- **WARNING:** Do not use Adaptive Cruise Control on winding roads with sharp curves, on icy or slippery road surfaces, or when weather conditions (e.g., heavy rain, snow, or fog) make it inappropriate to drive at a consistent speed. Adaptive Cruise Control does not adapt driving speed based on road and driving conditions.
- **WARNING:** Turn Adaptive Cruise Control off temporarily when driving in areas where you must reduce speed (e.g., turn lanes, entering and exiting highways, or construction zones). This prevents the vehicle from accelerating to the stored speed in such situations.

When engaged, Adaptive Cruise Control uses data from the vehicle's exterior sensors to automatically adjust your cruising speed, maintaining a safe distance from any vehicles

ahead. The default distance maintained is the furthest allowed. See [Adjusting following distance](#)

Adaptive Cruise Control is primarily intended for driving on dry, straight roads with no stops or sharp curves, such as highways and freeways.

If the adaptive Cruise Control cannot brake the vehicle safely, it will issue a takeover request.

*Note:* If your vehicle stops behind another vehicle and remains stationary for more than 10 minutes while Adaptive Cruise Control is active, the system will disengage and apply the Emergency Parking Brake (EPB).

### Setting and changing cruising speed

To activate Adaptive Cruise Control, press the  DreamDrive button on the steering wheel. See [Steering Wheel DreamDrive Controls](#).

*Note:* The DreamDrive mode defaults to Highway Assist for first-time users. When a User Profile is active, the system will go to the last used DreamDrive mode (Adaptive Cruise Control or Highway Assist). If Highway Assist is activated, press and hold the  DreamDrive button to switch to Adaptive Cruise Control.

To set the cruising speed:

- Push the left toggle up or down to adjust speed by  $\pm 1$  increment.
- Push and hold the left toggle up or down to adjust the set speed by  $\pm 5$  increments.

Minimum speed: 20 mph (30 km/h)

Maximum speed: 90 mph (150 km/h)

The cruising speed displays to the right of the speedometer on the Cockpit Panel, and is highlighted when Adaptive Cruise Control is active. Once activated, cruising speed can be changed using the same controls.

### Cruising speed

- **WARNING:** Occasionally, Adaptive Cruise Control may brake late or unexpectedly due to following a vehicle too closely, or if

detection issues occur due to road infrastructure (e.g., curves, bridges, or tunnels). At all times, the driver is responsible for watching the road, controlling the vehicle, and intervening if required.

Adaptive Cruise Control maintains your selected cruising speed when a vehicle is not detected in front of you.

When cruising behind a detected vehicle, highlighted in the Center Cockpit Panel, Adaptive Cruise Control accelerates and decelerates the vehicle as needed to maintain the set following distance up to the set speed. See [Adjusting following distance](#).

### Adopting new speed limits

When Cruise Speed Update is enabled, the system will prompt you on the Cockpit Panel when a new speed limit is detected. Press the left toggle button on the steering wheel to update the cruising speed to the new speed limit.

If you do not wish to update the cruising speed, the prompt will disappear after 7 seconds.

*Note:* If you do not wish to receive prompts regarding speed limit changes from Cruise Speed Update, they can be disabled.

### Driver override

- **WARNING:** During driver override, Adaptive Cruise Control will not apply the brakes to maintain the set following distance from a vehicle ahead.

While Adaptive Cruise Control is active, you can temporarily override the set speed using the accelerator pedal. If the Adaptive Cruise Control is overridden for more than 60 seconds, it will disengage.

When you press the accelerator pedal, the Center Cockpit Panel displays the following:



- ADAPTIVE CRUISE display will change to OVERRIDE
- Lane display, highlighted when Adaptive Cruise Control is active, will no longer be highlighted

- The target vehicle will not be highlighted

Once the accelerator is released, Adaptive Cruise Control should automatically resume and return to the cruise speed set by the driver. The Cockpit Panel displays the active Adaptive Cruise Control mode.

**Adjusting following distance**

- **WARNING:** It is your responsibility as the driver to determine and maintain a safe following distance at all times. Do not rely on Adaptive Cruise Control to maintain an accurate or appropriate following distance.
- **WARNING:** Never depend on Adaptive Cruise Control to adequately slow down the vehicle to avoid a collision. Always watch the road in front of you and be prepared to take corrective action at all times. Failure to do so can result in a collision with the risk of serious injury or death.

To adjust the vehicle's time gap settings from the vehicle ahead, press the  button on the steering wheel. See [Steering Wheel DreamDrive Controls](#). There are four time gap settings to select from, which will cycle as the  button is pressed.

The change in the time gap settings displays on the Center Cockpit Panel.

**Cancel and resume cruise control**

To cancel Adaptive Cruise Control, press the  Cancel button on the steering wheel. See [Steering Wheel DreamDrive Controls](#).

The system can also be canceled by pressing the brake pedal if it is safe to do so in the current traffic conditions.

After Adaptive Cruise Control has been canceled, you can resume the previously set speed by toggling up the left steering wheel control.

Highway Assist

The Highway Assist system detects lane markings and the presence of other vehicles to support the driver in staying within a lane

while maintaining the set speed and following distance.

- **WARNING:** Highway Assist is designed for your driving comfort and convenience and is not a collision warning or avoidance system. It is your responsibility to stay alert, drive safely, and be in control of the vehicle at all times.
- **WARNING:** Never depend on Highway Assist to adequately steer the vehicle. Always keep your hands on the steering wheel, watch the road in front of you, and be prepared to take corrective action. Failure to do so can result in serious injury or death.
- **WARNING:** Detection of lane markings and objects may malfunction, causing Highway Assist to make unexpected steering interventions. If this happens, then driver is responsible to steer according to traffic conditions.

Highway Assist is available on some roads. If you activate Highway Assist and then drive onto a road that Highway Assist does not support, the system will deactivate Highway Assist and activate Adaptive Cruise Control.

**Activating Highway Assist**

To activate Highway Assist, press the  DreamDrive button on the steering wheel. Press the toggle button to set desired cruise speed. .

*Note:* The DreamDrive mode defaults to Highway Assist for first-time users. When a User Profile is active, the system will go to the last used DreamDrive mode (Adaptive Cruise Control or Highway Assist). If Adaptive Cruise Control is activated and driving on a road that supports Highway Assist, press and hold the  DreamDrive button to switch to Highway Assist.



When Highway Assist is activated, the lane is highlighted, and an indicator displays on the Center Cockpit Panel.

*Note:* When Highway Assist has been temporarily overridden, this indicator and lane highlighting will gray out. Also when Highway Assist has been temporarily overridden by



---

pressing the accelerator pedal, the text will change to "Override".

### Traffic Jam Assist

- **WARNING:** When Traffic Jam Assist is following a leading vehicle and no lanes are detected, your vehicle may follow the lead vehicle into another lane. It is your responsibility to stay aware of your surroundings and be prepared to take corrective action at all times.

When the system cannot detect the lane lines or lane markings and there is a vehicle ahead, Highway Assist will follow the leading vehicle.

*Note:* Traffic Jam Assist is only available when the vehicle's speed is under 43 mph (70 km/h). When lanes are detected, the system prioritizes using the lanes over following a leading vehicle.

### Cooperative lane changing

To change lanes without disengaging or deactivating Highway Assist, activate the turn signal in the direction you will be changing lanes. See [Turn Signals](#) on page 74.

When you turn on the turn signal and turn the steering wheel, Highway Assist will be temporarily overridden, allowing you to manually complete the lane change. When the vehicle is centered in the new lane and both lane lines are detected, Highway Assist will automatically resume.

When you turn on the turn signal and turn the steering wheel in the direction of the intended lane change:

- The Highway Assist indicator will gray out
- The lane will not be highlighted

### Hands-off detection and in-lane stops

- **WARNING:** An in-lane stop is illegal in many areas. It is an emergency procedure only and should not be misused. Do not deliberately initiate an in-lane stop as a means to stop the vehicle.
- **WARNING:** An in-lane stop is meant to reduce the hazard of a moving vehicle that is not being consistently

controlled by the driver. However, a vehicle stopped in traffic can also be a hazard.

While Highway Assist helps you with steering, it is still necessary to keep your hands on the wheel and pay attention to the road at all times. If the system detects that the driver is distracted and their hands are no longer on the steering wheel, it will provide a series of warnings which, if not attended to, will lead to an in-lane stop.

If Highway Assist detects that the driver is distracted (not looking forward and their hands are not on the steering wheel) for longer than 6 seconds, a prompt will display on the Center Cockpit Panel.

If no steering wheel input has been detected for 15 seconds a warning will display on the Cockpit Panel, prompting the driver to put their hands on the steering wheel.

If still no steering wheel input has been detected after an additional 15 seconds:

- An elevated warning appears on the Cockpit Panel, prompting the driver to put their hands on the steering wheel.
- An alert sounds.
- The driver receives haptic brake feedback before in-lane stop deceleration begins.

The final stage of in-lane stop initiation depends upon the current speed of the vehicle, and will occur any time after 33 seconds of continuous detection that the driver's hands are off the steering wheel:

- The vehicle will gradually slow based upon the current speed.
- Hazard lights will activate.
- A flashing red animation appears on the Center Cockpit Panel.
- Audible warnings will sound.

*Note:* If the driver provides steering wheel input, or presses either the brake or accelerator during an in-lane stop, the system cancels the in-lane stop. If the vehicle has already started to slow down, Adaptive

Cruise Control and Highway Assist will be unavailable until the next drive cycle.

Once an in-lane stop has completed:

- The vehicle automatically shifts into P (Park).
- Highway Assist is canceled.
- DreamDrive will be unavailable until the next drive cycle.
- All doors unlock.
- An audible alert sounds.

Note: Warnings will be dismissed if the vehicle is shifted out of P (Park). See [Using the Drive Selector](#) on page 69.

### Steering override

While Highway Assist is active, you can temporarily override it by using the steering wheel. When you turn the steering wheel, the Highway Assist indicator will gray out on the Cockpit Panel.

Once the steering wheel returns to its neutral position, the vehicle is centered in the lane, and the system detects lanes again, Highway Assist should automatically resume and the Cockpit Panel will return to displaying the active Highway Assist mode.

### Manually canceling Highway Assist

To cancel Highway Assist, press the  Cancel button on the steering wheel.

The system can also be canceled by pressing the brake pedal if it is safe to do so in the current traffic conditions.

#### Traffic Sign Recognition

- **WARNING:** Traffic Sign Recognition is an assist feature only. The driver is responsible for paying attention to the road signs and determining the appropriate speed limit, road conditions, and driving speed.
- **WARNING:** Traffic Sign Recognition is not available in all countries.
- **WARNING:** Map data is not always accurate. The GPS can miscalculate

the vehicle location, which may provide an incorrect traffic sign.

- **WARNING:** If a road or a traffic sign has recently been changed, the Traffic Sign Recognition system may not be fully functional or may provide inaccurate information.
- **WARNING:** In situations where the Traffic Sign Recognition system is unable to determine a traffic sign, or if it is uncertain that an acquired speed limit is accurate, the system may not display the information and warnings may not take effect.

The Traffic Sign Recognition system uses the front cameras and navigation system data to recognize traffic signs on the road, providing you with driving information such as speed limits and other regulations.

When a traffic sign is detected, it displays on the Cockpit Panel next to the speedometer.



### Speed Limit Alerts

When Speed Limit Alert is enabled (see [Speed Limit Alert Settings](#)), if the current vehicle speed exceeds the detected speed limit, the display color of the speed limit sign will change color and may increase in size. The display will return to the normal color and size when the vehicle is slowed to within the speed limit.

### Wrong-way warnings

If a Wrong Way road sign is detected and the vehicle passes the sign, the system will alert you with an audible alert and a notification on the Cockpit Panel.

### Speed Limit Alert settings

To configure Speed Limit Alert settings, use the Pilot Panel and touch  >  DreamDrive.

- Touch to enable or disable Speed Limit Alert. Additional options to receive VISUAL or VISUAL AND AUDIO alerts are available when this feature is enabled.
- Touch to enable or disable Cruise Speed Update. When enabled, this feature

---

notifies you when a new speed limit is detected and prompts you with an option to update your cruising speed when Adaptive Cruise Control is active. It is the driver's responsibility to determine the appropriate speed limit, road conditions, and driving speed. .

*Note:* When this feature is disabled, the detected speed limit will still be displayed next to the set cruise speed on the Cockpit Panel.

---

#### Traffic Drive-Off Alert

- **WARNING:** Never assume it is safe or legal to proceed when Traffic Drive-Off Alert activates. Always check your surroundings first.

When your vehicle comes to a stop behind traffic (or another stopped vehicle), the Traffic Drive-Off Alert system monitors the driver and alerts them if they are distracted when the front vehicle pulls away from a stopped position.

If a stopped vehicle in front pulls away, the system provides audible and visual alerts if the interior camera detects that you are not facing forward.

*Note:* If the interior camera detects that you are already facing forward, you will not receive Traffic Drive-Off Alerts.

When Adaptive Cruise Control is active and the vehicle is stopped, you will receive a prompt on the Cockpit Panel once the traffic ahead clears. You can resume cruising speed by pressing the accelerator, or by pushing up on the left steering wheel toggle

If you do not react to the initial prompt within a few seconds, the prompt will change and the system will sound an audible alert if the driver is distracted.

#### Traffic Drive-Off Alert settings

To configure Traffic Drive-Off Alert settings, use the Pilot Panel and touch  >

 DreamDrive, then press to enable or disable Traffic Drive-Off Alert.

*Note:* The Traffic Drive-Off Alert setting will be saved to the current active User Profile, and will not reset at each drive cycle.

---

#### Distracted Driver Alert

- **WARNING:** Do not rely on the Distracted Driver Alert to maintain your focus on the road. The driver is responsible for paying attention at all times while operating the vehicle.

When enabled, the Distracted Driver Alert system will monitor the driver via the interior camera, and issue alerts when it detects that the driver's eyes are not on the road.

*Note:* In some circumstances the interior camera might be blocked. In this case, both the distracted driver and drowsy driver alerts will be unavailable. In this case an alert will appear on the center cockpit panel. When the obstruction is removed, driver will be notified.

*Note:* Distracted Driver Alert is not available when the vehicle's speed is below 25 mph (40 km/h).

If the system detects that the driver's eyes are off the road for 2 seconds, an alert will display on the Cockpit Panel and a chime will sound.

If the system detects that the driver has their eyes off the road for an additional 3-5 seconds, a warning will display on the Cockpit Panel. A chime will sound and a haptic pulse will vibrate the steering wheel to alert the driver.

#### Distracted Driver Alert settings

To configure Distracted Driver Alert settings, from the Pilot Panel touch  >

 DreamDrive, then enable or disable Distraction Alert. Distraction settings save to the current User Profile.

---

#### Drowsy Driver Alert

- **WARNING:** Do not rely on the Drowsy Driver Alert to warn you when you are not focusing on the road or driving erratically. Drive to a safe area and park when you're unable to focus on driving.

When enabled, the Drowsy Driver Alert system issues alerts when it detects early signs of drowsiness. This system monitors for the following signs:

- Frequent driver eye closure (detected via the interior camera)
- Erratic driving behavior (such as swerving)

Note: Drowsy Driver Alert is not available when the vehicle's speed is below 25 mph (40 km/h).



If the system detects signs of driver drowsiness, a notification will appear on the Center Cockpit Panel.



When Drowsy Driver Alert activates, an indicator displays on the Cockpit Panel until the vehicle has been stopped or shifted out of D (Drive).

In addition to the alert, the right Cockpit Panel will display a list of nearby break areas when available. If desired, press a location to add a waypoint to your current trip and navigate to that break area. See [Navigating](#).

If the system detects continued signs of drowsiness after the first alert, a warning notification appears on the Cockpit Panel and an audible alert sounds.

In addition to the alerts, the right Cockpit Panel displays a list of nearby break areas when available. Press SHOW ME to view the list, or DISMISS to clear.

If the system still detects signs of drowsiness after the second alert, a new warning notification appears in addition to a louder audible alert and haptic vibration of the steering wheel. Hazard lights are activated. The right Cockpit Panel again displays a list of nearby break areas.

Responses include:

- Pressing a selection in the prompt on the right Cockpit Panel
- Double-clicking the Hazard Light button

- Stopping the vehicle
- Shifting out of D (Drive)

### Drowsy Driver Alert settings

On the Pilot Panel, press >

DreamDrive, then press to enable or disable Drowsy Driver Alert. Drowsy Driver settings save to the current User Profile

### High Beam Assist

- **WARNING:** High Beam Assist is an aid for selecting the best possible lighting based on prevailing conditions. The driver is always responsible for manually switching between high and low beam depending on the traffic situation or weather condition.

High Beam Assist is a feature that uses the vehicle's cameras to detect the headlights of approaching vehicles or the taillights of the vehicle directly ahead.

When either of these is detected, the vehicle's headlight's will automatically switch from high beams to low beams.

When the camera sensor no longer detects an approaching vehicle or a vehicle ahead, the headlights will return to high beams.

Note: The feature may automatically switch to low beams when street lighting is detected.

Note: This feature will only operate in dark conditions when the vehicle's speed is greater than 18 mph (30 km/h).

### Activating High Beam Assist

1. Make sure the feature is enabled from the DreamDrive settings.
2. Put the light settings in Auto mode.
3. Push the left steering column lever away from you to turn on high beams.





The High Beam Assist indicator is displayed on the Instrument Cluster whenever the system is activated.



If the system detects a fault, an indicator will be displayed on

---

the Instrument Cluster, and High Beam Assist will be unavailable. Headlight high beams can still be operated using the left steering column lever.

High Beam Assist can be enabled or disabled using the Pilot Panel. Select  >  Vehicle > Drive Settings, then press to enable or disable High Beam Assist.

### **Reduced High Beam Sensitivity**

If High Beam Assist is enabled and the vehicle is parked, tapping and holding the High Beam Assist label in the Pilot Panel for 30 seconds would reveal the Reduced High Beam Sensitivity option.

*Note:* This option will not appear if vehicle is not in Park and will disappear automatically if vehicle is in motion.

- **WARNING:** Reduced high beam sensitivity may result in blinding of oncoming traffic. Lucid does not advise customers to use this mode.

# Collision Detection and Protection



## Collision Protection

Collision Protection includes Automatic Emergency Braking, Forward Collision Warning, and Rear Pedestrian Collision Protection. See [Forward Collision Warning](#) on page 106 and [Rear Pedestrian Collision Protection](#) on page 107.

Collision Protection is always enabled when you start the vehicle.

### Collision Protection settings

- **WARNING:** Lucid strongly recommends that you leave this feature enabled to provide potential supplemental assistance and to help avoid serious injury.

To configure Collision Protection, from the Pilot Panel touch  >  DreamDrive, then enable or disable Collision Protection.

- When enabled, you can press to select the level of sensitivity for Forward Collision Warnings: EARLY, NORMAL (default), or LATE.

*Note:* Sensitivity levels do not affect the actual braking distance.

*Note:* The selected sensitivity level will be saved to the current User Profile.

- If you select to disable Collision Protection, you will be prompted to confirm your selection.



When Collision Protection is disabled, an indicator displays on the Cockpit Panel.

### Automatic Emergency Braking

- **WARNING:** Automatic Emergency Braking is not designed to prevent a collision, but to minimize the impact of a frontal collision by attempting to reduce your driving speed. Depending solely on Automatic Emergency Braking to avoid a collision can result in serious injury or death.

- **WARNING:** Automatic Emergency Braking only applies the brakes. It does not steer the vehicle out of the path of the hazard.
- **WARNING:** There are factors that can affect the performance of Automatic Emergency Braking, causing either no braking or inappropriate or untimely braking. It is your responsibility to drive safely and remain in control of the vehicle at all times. Never depend on Automatic Emergency Braking to avoid or reduce the impact of a collision.
- **WARNING:** The brake pedal moves downward abruptly during Automatic Emergency Braking events. Always ensure that the brake pedal can move freely. Do not place material (including additional mats) under or on top of the vehicle-supplied floor mat and always ensure that the driver's floor mat is secured properly. Failure to do so can impede the ability of the brake pedal to move freely.

Working in conjunction with Forward Collision Warning, the Automatic Emergency Braking system detects the presence of an object such as a vehicle, bicycle, or pedestrian. If the system determines an imminent collision with an object to the front it will initiate emergency braking to reduce the severity of the impact.

If the driver presses the brake during an Automatic Emergency Braking event, the system will provide additional brake support.

When Automatic Emergency Braking applies the brakes, an audible warning sounds, and a visual warning appears on the Cockpit Panel. You may also notice movement of the brake pedal.

*Note:* If active, the Adaptive Cruise Control and Highway Assist systems will automatically deactivate if an Automatic Emergency Braking event is triggered. See [Adaptive Cruise Control](#) and [Highway Assist](#).

*Note:* Automatic Emergency Braking does not apply the brakes or stops applying the brakes when:

- Steering wheel is turned abruptly.
- Brake pedal is pressed and released while Automatic Emergency Braking is applying the brakes.
- Accelerator is pressed abruptly while Automatic Emergency Braking is applying the brakes.
- Hazard (vehicle, motorcycle, bicycle or pedestrian) is no longer detected in the vehicle path.

*Note:* Automatic Emergency Braking can be adversely affected by the limitations of Advanced Driver Assistance components. See [ADAS Limitations](#). Use appropriate caution when driving.



If Automatic Emergency Braking is unavailable, a warning message and indicator display on the Cockpit Panel. If either of these items appear, contact a Lucid Service Center.

### Speed limitations

- **WARNING:** The Automatic Emergency Braking system automatically disables when you manually disable Lucid Stability Control.

The Automatic Emergency Braking system, including Forward Collision Warning, is active at speeds above approximately 4 mph (7 km/h) and up to 112 mph (180 km/h). Pedestrian detection and reaction to stationary vehicles is active at speeds up to 53 mph (85 km/h).

### Automatic Emergency Braking settings

See [Collision Protection](#) on page 105.

Forward Collision Warning

- **WARNING:** Forward Collision Warning is an assist feature only, and is not a substitute for attentive driving and sound judgment. The driver is responsible for paying attention to the road, maintaining a suitable distance from the vehicle ahead, and braking or steering the vehicle when necessary.
- **WARNING:** There are factors that can reduce or impair the performance of

the Forward Collision Warning system, causing either unnecessary, invalid, inaccurate, or missed warnings. Do not rely solely on Forward Collision Warning to warn you of a potential collision.

- **WARNING:** Forward Collision Warning only monitors what is in front of the vehicle. Be aware of your surroundings at all times while operating the vehicle.
- **WARNING:** Forward Collision Warning does not provide alerts when the driver is already applying the brake.

The Forward Collision Warning system uses the front camera mounted behind the windshield and the radar sensor mounted behind the front bumper to detect the presence of an object (such as a vehicle, bicycle, or pedestrian).

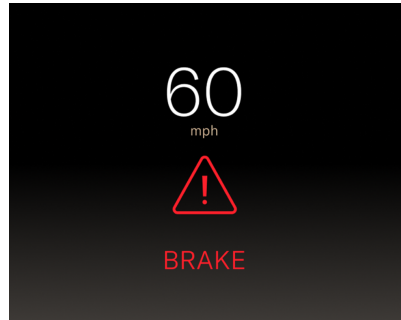

If the system detects that a collision is likely to happen, it will sound an alert and prompt you to brake in the Center Cockpit Panel. If this happens, TAKE IMMEDIATE CORRECTIVE ACTION and apply the brakes or steer clear of the impending collision.

*Note:* If the driver presses the brake, the system provides additional brake support.

If you do not react sufficiently to the warning, the Automatic Emergency Braking system should reduce speed, which is intended to help reduce the severity of a collision.

When Automatic Emergency Braking is activated, the Cockpit Panel flashes red and an audible alert sounds. If this happens, TAKE IMMEDIATE CORRECTIVE ACTION.

## Forward Collision Warning settings

See [Collision Protection](#) on page 105.

### Rear Pedestrian Collision Protection

- **WARNING:** Rear Pedestrian Collision Protection is an assist feature only, and is not a substitute for attentive driving and sound judgment. The driver is responsible for paying attention while reversing, monitoring the surroundings, and braking or steering the vehicle when necessary.
- **WARNING:** There are factors that can reduce or impair the performance of the Rear Pedestrian Collision Protection system, such as low ambient light conditions, causing either unnecessary, invalid, inaccurate, or missed warnings. Do not rely solely on Rear Pedestrian Collision Protection to warn you of a potential collision.
- **WARNING:** Rear Pedestrian Collision Protection only monitors for pedestrians behind the vehicle. It does not detect objects, and does not detect pedestrians outside of the range of the rear camera. Be aware of your surroundings at all times while operating the vehicle.
- **WARNING:** Rear Pedestrian Collision Protection does not provide alerts when the driver is already applying the brake.

When the gear is in N (Neutral) or R (Reverse) and backward vehicle motion is detected, Rear Pedestrian Collision Protection uses the rear camera to monitor for pedestrians behind the vehicle. If a collision is imminent, the system issues a warning and applies the brakes. Rear Pedestrian Collision Protection is active at speeds below 11 mph (18 km/h).



If the system detects that a rear collision with pedestrians is likely to happen, it will sound

an audible alert and prompt you to brake on the right Cockpit Panel. If this happens, TAKE IMMEDIATE CORRECTIVE ACTION.

If you do not react sufficiently to the warning, the emergency braking will activate to reduce the severity of the collision.

### Cross Traffic Protection

- **WARNING:** Cross Traffic Protection is an assist feature only, and is not a substitute for attentive driving and sound judgment. The driver is responsible for paying attention while driving, monitoring the surroundings, and braking or steering the vehicle when necessary.
- **WARNING:** There are factors that can reduce or impair the performance of the Cross Traffic Protection system, causing either unnecessary, invalid, inaccurate, or missed warnings. Do not rely solely on Cross Traffic Protection to warn you of a potential collision.
- **WARNING:** Cross Traffic Protection does not detect smaller objects outside of the range of the sensors. This could include (but is not limited to) small children or animals. Be aware of your surroundings at all times while operating the vehicle.
- **WARNING:** Cross Traffic Protection does not provide alerts when the driver is already applying the brake.

Cross Traffic Protection warns the driver when there is a risk of collision with crossing traffic approaching from the left or right to the front or rear side of the vehicle and will automatically apply emergency braking if needed.

When enabled, Cross Traffic Protection is active at speeds below 10 mph (16 km/h) for warnings, and speeds below 6 mph (10 km/h) for braking.

*Note:* Cross Traffic Protection is not available when the gear is in P (Park). Front cross traffic alerts or braking will not be issued if vehicle speed exceeds 6 mph (10 km/h) or driven distance is over 131 ft (40 m) after shifting from P (Park) to D (Drive) gear.



When the gear is in D (Drive) or N (Neutral) and forward vehicle motion is detected, Cross Traffic Protection will sound an alert and prompt on the Cockpit Panel when a collision risk is detected.

If the vehicle is moving and the driver does not react in time, the system will activate emergency braking.



When the gear is in R (Reverse) or N (Neutral) and backward vehicle motion is detected, Cross Traffic Protection will sound an alert and prompt on the right Cockpit Panel when a collision risk is detected.



If the vehicle is moving and the driver does not react in time, the system will activate emergency braking.

### Cross Traffic Protection settings

- **WARNING:** Lucid strongly recommends that you do not disable Cross Traffic Protection when driving. Disabling this feature deactivates alerts and emergency braking which increases the risk of causing or contributing to a crash.

To configure Cross Traffic Protection, from the Pilot Panel touch  >  DreamDrive, then press to enable or disable Cross Traffic Protection. Settings save to the current User Profile.

### Lane Departure Protection

- **WARNING:** Lane Departure Protection is for guidance purposes only and is not intended to replace your own direct visual checks. Never depend on Lane Departure Protection to inform you of unintentionally driving outside of the boundaries of the driving lane or road edge. Always stay alert, pay attention to the driving lane and always be aware of other road users.

Failure to do so can result in serious injury or death.

- **WARNING:** Lane Departure Protection is designed to detect lane markings and certain road edges. It is your responsibility to drive attentively and stay within the boundaries of the driving lane.
- **WARNING:** Any changes to the vehicle's suspension or wheel height may result in degraded feature performance or no activation.
- **WARNING:** Excessive crosswinds, large road crown, improper tire pressures, or vehicle loading conditions can affect the feature's performance.

When enabled, Lane Departure Protection helps the driver to prevent the vehicle from unintentionally straying out of a detected lane by providing steering correction along with visual and haptic alerts (if enabled).

Lane Departure Protection is available at vehicle speeds between 30-124 mph (50-200 km/h) for detecting lanes, and between 40-85 mph (60-140 km/h) for detecting road edges.

*Note:* Lane Departure Protection is temporarily overridden when a turn signal is activated (see [Turn Signals](#)). Once you have steered into another lane and the turn signal automatically deactivates, Lane Departure Protection will resume if lane lines are detected.

When the system detects an unintentional drift toward the lane or road boundaries:

- An alert displays on the Cockpit Panel, highlighting the side the vehicle is drifting towards.
- If enabled, the steering wheel will provide a haptic vibration.
- Steering correction is applied to bring the vehicle back into the lane or road.



If two or more steering corrections are detected within 180 seconds without the driver's hands on the steering wheel, an audible alert will sound on the second correction. For any consecutive steering

corrections, audible alerts will be longer in duration.

Lane Departure Protection alerts will be canceled immediately if any of the following actions happen:

- A turn signal is activated
- Intentional steering
- Intentional acceleration
- Intentional braking

### Lane Departure Protection settings

To configure Lane Departure Protection, from the Pilot Panel touch  >  DreamDrive, then enable or disable Lane Departure Protection. Settings save to the current User Profile.



When Lane Departure Protection is disabled or unavailable, an indicator will display on the Cockpit Panel.

When enabled, press INTERVENTION ONLY (default) or WARNING AND INTERVENTION if you wish to receive haptic vibrations of the steering wheel when a steering correction is recommended.

Warnings cancel automatically when the risk of an unintentional lane departure has been reduced (such as when you steer the vehicle back to the current lane).

#### Blind Spot Warning

- **WARNING:** Blind Spot Warning should not be used as a replacement for checking the interior and exterior mirrors or looking over your shoulder before changing lanes. It's the driver's obligation to stay alert, pay attention to traffic, and take action if necessary.
- **WARNING:** Blind Spot Warning may not cover an extended blind spot zone when a trailer is attached to a detected vehicle.

Blind Spot Warning provides visual and (when enabled) audible warnings when the vehicle is in motion and the system detects an object in your blind spot or close to the side of your vehicle.

Warnings cancel automatically when the risk of a collision is no longer present, or when a vehicle is no longer detected in the blind spot.



When an object is detected in a blind spot, the amber LED in the mirror on that side will illuminate.



*Note:* If the vehicle speed is above 6 mph (10 km/h) and a turn signal is activated in the direction of the object, the amber LED in the corresponding mirror will flash.

If a turn signal is activated in the direction of the object in a blind spot, visual and (when enabled) audible warnings will activate.

If Blind Spot Display is activated, a camera view of that blind spot will also be displayed. See [Blind Spot Display](#).

*Note:* Blind Spot Display is only available at vehicle speeds above 25 mph (40 km/h).

### Blind spot warning settings

To configure Blind Spot Warning, from the Pilot Panel touch  >  DreamDrive, then press to enable or disable Blind Spot Warning. Settings save to the current User Profile.

When enabled, press to select whether to receive VISUAL (default) or VISUAL AND AUDIO warnings. If disabled, visual and audible warnings on the Cockpit Panel are no longer issued. Warnings via LED's on exterior rear view mirrors are still provided.

#### Blind Spot Display

- **WARNING:** Blind Spot Display should not be used as a replacement for checking the interior and exterior mirrors or looking over your shoulder before changing lanes. It is the driver's obligation to stay alert, pay attention to traffic, and take action if necessary.



---

Blind Spot Display uses the exterior cameras to project an image of the blind spot field of view onto the Cockpit Panel when a turn signal is activated, helping the driver to assess the surroundings. See [Turn Signals](#).

*Note:* Blind Spot Display is only available at speeds above 25 mph (40 km/h).

With Blind Spot Display enabled, activating a turn signal will bring the camera view up for that side on the Center Cockpit Panel.

### **Blind Spot Display settings**

To configure Blind Spot Display, from the Pilot Panel touch  >  DreamDrive, then enable or disable Blind Spot Display on Glass Cockpit. Settings save to the current User Profile.

# Parking Experience

## Automatic Park In

- **WARNING:** Automatic Park In does not consider objects located outside the range of sensors during the detection of parking spaces or calculating the parking path. Continually check your surroundings throughout the parking sequence. Be prepared to apply the brake and take control to avoid pedestrians, vehicles, or objects.
- **WARNING:** It is the driver's responsibility to determine whether it is safe and legal to park in a parking space detected by Automatic Park In.

Automatic Park In takes control of shifting, accelerating, braking, and steering the vehicle into a parking space.

*Note:* The sensors only detect parking spaces that are bounded by a three-dimensional object on at least one side (such as an open space next to a vehicle or between two vehicles).

*Note:* Automatic Park In cannot detect or park in diagonal spaces.

### Using Automatic Park In

To activate Automatic Park In, press **P** on the Pilot Panel. Once activated, the system searches for parking spaces using the exterior sensors. Drive forward slowly to allow the system to scan the surroundings.

*Note:* The vehicle must be moving below approximately 15 mph (25 km/h) to scan. If it is moving too fast, the system will prompt you visually and audibly to slow down.

*Note:* You must drive past a space before it can be fully detected.



Detected spaces will be displayed on the Pilot Panel and Cockpit Panel. An audible alert will sound for each one. If you wish to park in a detected space:

1. Bring the vehicle to a full stop.
2. Press and hold the brake pedal.
3. On the Pilot Panel, press a space to select it.

*Note:* The system can detect up to 4 parking spaces at a time.

When the system prompts you, release the brake pedal and steering wheel to begin parking. An audible alert will sound when vehicle movement begins. During Automatic Park In, the rear view camera displays on the right Cockpit Panel.

The Pilot Panel will display parking in progress. Monitor your surroundings throughout the parking sequence and be prepared to take control of the vehicle at any time.

- Automatic Park In can be stopped at any time by pressing the brake pedal,

---

and will resume automatically when the brake is released.

- If a system detects an obstacle in the vehicle's trajectory, it will stop the vehicle and prompt you to brake. When the hazard has cleared, the RESUME button on the Pilot Panel becomes available. Press RESUME and release the brake to continue the parking sequence.
- **WARNING:** Automatic Park In does not guarantee braking for an obstacle. The driver is responsible to observe surroundings and brake as needed.

- Press CANCEL at any time to stop Automatic Park In. Be prepared to take control of the vehicle. See [Automatic Park In](#) on page 111.

*Note:* When the vehicle switches gears, an audible alert will sound.

The Pilot Panel will prompt when parking has completed and an audible alert will sound. The vehicle will automatically shift into P when parking has completed,

*Note:* If the system detects a curb or slope, it will set the wheels accordingly. To disable this feature, see [Automatic Park In](#) on page 111.

### Canceling Automatic Park In

During the automated parking sequence, Automatic Park In will be canceled immediately if any of the following incidents occur:



- System or sensor faults
- Driver presses the accelerator pedal, holds the steering wheel, or shifts gears
- Driver unbuckles the seat belt
- Driver presses CANCEL on the Pilot Panel
- The trunk, the hood, or a door is not closed
- The selected parking space is found to be too small after initial scan
- System cannot park safely after 8 tries

- Road slope or grade is too high
- Road is too slippery or provides poor tire traction
- A safety system activates (such as Collision Protection or Automatic Emergency Braking. See [Collision Detection and Protection](#) on page 105)

When the system is canceled, the vehicle will stop, emit an audible alert, and prompt the driver to take control of the steering wheel and brake pedal. If there is no response from the driver after 30 seconds, the vehicle automatically shifts into P (Park).

If Automatic Park In cancels for any of the aforementioned reasons and you wish to use the system again, you must start over at the beginning of the process and scan for a space.

### Automatic Park In settings

To configure Blind Spot Display, from the Pilot Panel touch  >  DreamDrive, then press to enable or disable Auto Park Wheel Curb Assist. Settings save to the current User Profile.

---

#### Automatic Park Out

---

- **WARNING:** Automatic Park Out does not consider objects located outside the range of sensors during the pull-out sequence, including oncoming traffic. Continually check your surroundings throughout the pull-out sequence, and be prepared to apply the brake and take control to avoid hazards.

Automatic Park Out takes control of shifting, accelerating, braking, and steering the vehicle, positioning it to pull straight out of a parallel parking space.

*Note:* Automatic Park Out is only used to help exit parallel parking spaces.

*Note:* Automatic Park Out can only be activated when the vehicle is in P (Park).

### Using Automatic Park Out

To activate Automatic Park Out, press  on the Pilot Panel. Press and hold the brake pedal, then tap the direction to pull out. Keep

holding the brake pedal while the vehicle scans the available space.

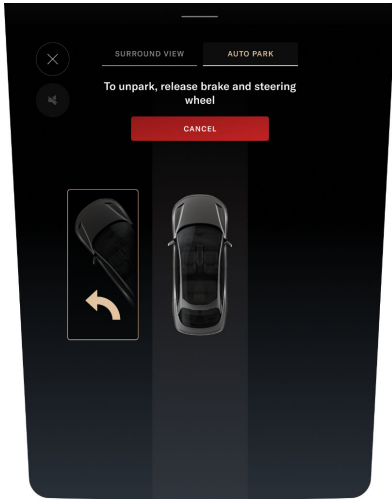

When the system prompts you, release the brake and steering wheel to begin the pull-out sequence. An audible alert will sound when vehicle movement begins. A turn signal activates in the direction you're turning out.

*Note:* The driver is still responsible to make sure the turn signal is in the correct direction.

During Automatic Park Out, the rear view camera displays on the right Cockpit Panel.

The Pilot Panel displays "unpark in progress". Monitor your surroundings throughout the sequence and be prepared to take control of the vehicle at any time.

- Automatic Park Out can be stopped at any time by pressing the brake pedal, and will resume automatically when the brake is released.
- If a system detects an obstacle in the vehicle's trajectory, it will stop the vehicle and prompt you to brake. When the hazard has cleared, the RESUME button on the Pilot Panel becomes available. Press RESUME and release the brake to continue the parking sequence.

- Press CANCEL at any time to stop Automatic Park Out. Be prepared to take control of the vehicle. See [Automatic Park Out](#) on page 112.

*Note:* When the vehicle switches drive modes, an alert sounds.

When the system has completed the sequence:

- The gear will automatically shift into D (Drive).
- The system will hold the vehicle in place with the brake.
- The Pilot Panel will prompt you visually and audibly to take control of the vehicle.

If there is no response from the driver after 20 seconds, the gear will automatically shift into P (Park).

*Note:* If Park Out direction is unavailable, the pilot panel alerts you.

### Canceling Automatic Park Out

During the automated pull-out sequence, Automatic Park Out will be canceled immediately if any of the following incidents occur:

- System or sensor faults
- Driver presses the accelerator pedal, holds the steering wheel, or shifts gears
- Driver presses CANCEL on the Pilot Panel
- Driver unbuckles the seat belt
- The trunk, the hood, or a door is not closed
- The selected parking space is found to be too small after initial scan
- System cannot park safely after 8 tries
- Road slope or grade is too high
- Road is too slippery or provides poor tire traction

- A safety system activates (such as Collision Protection or Automatic Emergency Braking. See [Collision Detection and Protection](#) on page 105)

When the system is canceled, the vehicle will stop, emit an audible alert, and prompt the driver to take control of the steering wheel and brake pedal. If there is no response from the driver after 20 seconds, the gear will automatically shift into P (Park).

If Automatic Park Out cancels for any of the aforementioned reasons and you wish to use the system again, you must start over at the beginning of the process.

#### Surround View Monitoring

- **WARNING:** The Surround View Monitoring system should not be used as a replacement for looking into the interior and exterior mirrors or looking over your shoulder when operating and parking the vehicle. Always inspect your surroundings with your own eyes.

The Surround View Monitoring system uses the exterior cameras to display the immediate vehicle surroundings in real time. This system assists you in situations such as parking or at exits with reduced visibility.

*Note:* Surround View Monitoring is only available when the vehicle's speed is below 9 mph (15 km/h).

#### Using Surround View Monitoring

To activate the system, press  on the Pilot Panel, then select SURROUND VIEW.

When the gear is in R (Reverse), Surround View Monitoring will activate automatically on the Pilot Panel.

Press  at any time to close the screen.

*Note:* When Park Distance Warning is activated, visual indicators for object distance will be displayed. See [Park Distance Warning](#).

To manipulate the view, use any of the following screen gestures:

- Use one finger to press and drag, panning the screen to move the camera angle in any direction.
- Double tap the screen to zoom and center on the image. Double tap again to zoom out.
- Pinch inward with two fingers on the screen to zoom out the camera angle. Reverse the gesture to zoom in.
- Use all five fingers to pinch in on the screen, and the system will return to the default top-down view.



In the default top-down view, press a  camera button to switch to a 3D view from that camera angle.

Press a  camera button on the front or rear of the displayed vehicle to switch to the camera view from the front or rear bumper.

In 3D view, press the  button to switch to the top-down view.

#### Surround View Monitoring limitations

In addition to the limitations of Advanced Driver Assistance components (see [ADAS Limitations](#)), the Surrounding View Monitoring system may not function correctly in these situations:

- The trunk, the hood, or a door is not closed

- The side mirrors are folded in
- The trunk or hood is open

act to prevent a collision. It is the driver's responsibility to assess the surroundings and take action when necessary.

Rear View Monitoring

- **WARNING:** The Rear View Monitoring system should not be used as a replacement for looking into the interior and exterior mirrors or looking over your shoulder when operating and parking the vehicle. Always inspect your surroundings with your own eyes.

Rear View Monitoring is an assist feature that automatically displays the rear camera view on the right Cockpit Panel when the vehicle shifts into R (Reverse). See [Selecting a Drive Mode](#).

To manually activate Rear View Monitoring, press  on the Pilot Panel.



To manipulate the camera view, do any of the following:

- Swipe down on the screen to switch to the front camera view, or swipe up for the rear camera view.
- Pinch outward with two fingers on the screen to zoom in the camera angle. Reverse the gesture to zoom out.

*Note:* The current magnification level will be displayed to the right of the camera view.

- Press the +/- buttons to zoom the view in/out.
- Press  to close the screen.

Park Distance Warning

- **WARNING:** Park Distance Warning is an assist feature only, and will not

Park Distance Warning uses the exterior sensors to provide you with visual and audible alerts when the vehicle is slowly moving towards a potential hazard.

*Note:* This feature is only available at speeds below 10 mph (15 km/h).

When enabled, the system provides visual and audible alerts on these camera views:

Right Cockpit Panel:

- [Rear View Monitoring](#)

Pilot Panel:

- [Surround View Monitoring](#)

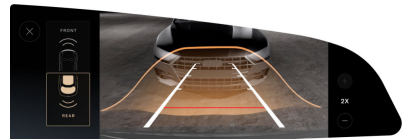

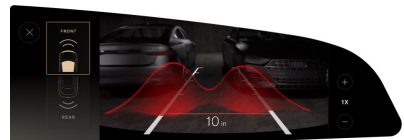

The shade of the visual indicator represents how close your vehicle is to an object. Objects that are further away will be indicated by a neutral shade.



As your vehicle approaches an object, the visual indicator will gradually intensify to a darker shade of red. If this happens, apply the brakes to slow the vehicle and take any other appropriate corrective action.

**Park Distance Warning settings**

To configure Park Distance Warning settings, from the Pilot Panel touch  >

 DreamDrive, then enable or disable Park



---

Distance Warning. Settings save to the current User Profile.

07

# Infotainment



---

# User Profiles

## About User Profiles

---

You can create multiple User Profiles for your vehicle, enabling everyone to personalize their vehicle settings, including:

- Preferences for entry to and exit from the vehicle (see [Loading and Switching Profile Preferences](#) on page 120)
- Seat positioning (see [Adjusting the Front Seats](#) on page 30)
- Positioning of exterior mirrors (see [Adjusting the Exterior Side Mirror Position](#) on page 72)
- Certain Drive settings (see [Drive Modes](#) on page 70)
- Preferences for units of measurement (press  >  Displays > Units).
- Paired Bluetooth® phones, including synced contacts, calls, and messages (see [Pairing a Bluetooth Device](#) on page 134)
- Music and audio preferences, such as radio stations and third-party media applications (see [Playing Media from Devices](#) on page 126)
- Interior lighting and display themes (see [Interior Lights](#) on page 76)
- Personalized Home and Work navigation destinations (see [Navigation Overview](#) on page 129)

### User Profile types

There are three types of User Profiles, each with its own levels of access:

- **Owner:** This is the main Profile with access to all features, including Lucid ID syncing and User Profile removal. There is only one Owner Profile. See [Creating a User Profile](#) on page 118.
- **Secondary Driver:** Additional regular users of the vehicle who would like to

create a User Profile can store their individual preferences and settings. The vehicle can save up to three Secondary User Profiles. See [Creating a User Profile](#) on page 118.



- **Guest:** This is for any user who requires temporary access to the vehicle or any regular user who does not wish to create a Profile. The Guest Profile does not have access to any profile detection features and will not save adjustments to the seat, steering wheel, or external mirrors. There is only one Guest Profile.

## Creating a User Profile

---

### Setting up the Owner Profile

In a new vehicle, an Owner Profile setup prompt will appear on the right Cockpit Panel at the end of a driving session. Press SET UP to begin the setup process.

To access setup manually on the Pilot Panel, press  >  Access and Profiles, then press SET UP THIS PROFILE.

*Note:* The vehicle gear must be set to P (Park) and remain there throughout the setup process.

*Note:* Do not skip the first step, but you can press EXIT SETUP on any subsequent steps and complete them later via the  Access and Profiles menu. You can also press < to return to the previous step.

1. Sign in with your Lucid ID. This allows your data to be synced to other Lucid vehicles and to the Lucid mobile app, through which you can remotely access your vehicle and its data.

*Note:* Your Lucid ID is set up at the time you purchase your vehicle. If you cannot locate your login information, contact Lucid Customer Care for assistance. See [Customer Care](#) on page 211.

2. Enter a profile name and select an avatar.
3. Enter a 5-digit Personal Identification Number (PIN) of your choosing, then

enter it again to confirm. Confirm your identity with your pin if you choose not to enable Face Login

4. Press to link a key fob or phone to your Profile. Your vehicle will automatically load your Profile if your linked device is detected. Follow the on-screen directions to link a device.

*Note:* The device must be in your hand during setup, as some user interaction is required. If linking a smartphone, have the Lucid mobile app opened and sign into it with your Lucid ID.

5. Use the touchscreen to set your Home and Work addresses. This allows you to access shortcuts to these destinations, such as when using maps. See [Maps and Navigation](#) on page 129.
6. Set up facial recognition to quickly load your profile when you enter the vehicle.



### Setting up Additional Profiles

To add another User Profile:

- Sign in using the Owner Profile.
- Make sure the vehicle is parked, and remain there throughout the setup process.

On the right Cockpit Panel, press + Profile Settings to launch the Access & Profiles Settings on the Pilot Panel.

*Note:* The option to create or add a User Profile will not be available if the maximum number of Profiles has already been added. If you wish to delete a Profile in order to add another, see [Removing Secondary User Profiles](#) on page 120.

On the Pilot Panel, press  >  Access and Profiles, then press CREATE NEW PROFILE. After a prompt for the primary driver's PIN:



1. Enter a profile name, and select an avatar.
2. Press to link a key fob or phone to the Profile. Your vehicle will automatically load the Profile if the linked device is detected.

Follow the on-screen directions to link a device.

*Note:* The device must be in your hand during setup, as some user interaction is required. If linking a smart phone, you must have the Lucid mobile app opened and be signed into it with your Lucid ID.

### Profile Settings

There are multiple ways to access your User Profile settings:

- On the right Cockpit Panel, press your avatar image, then select PROFILE SETTINGS to launch.
- On the Pilot Panel, press  >  Access and Profiles. From here, you can press to toggle Automatically Load Preferences on or off (see [Loading User Profile Preferences](#)), or select from the listed menu options.

### Changing profile name and avatar

In the Lucid Mobile App, you can change the avatar for the Owner Profile and/or the name and avatar for the Secondary Profiles.

### My Profile

Under My Profile, you can view and edit your Home and Work addresses or reset your Personal Identification Number (PIN).

*Note:* Secondary Profiles must have access granted from the Owner in order to reset a PIN. When prompted, press REQUEST ACCESS. The Lucid mobile app tied to the Owner's Lucid ID will need to be opened within a certain time frame in order to grant access.

### Profile Detection

Under Profile Detection, you have options to add, edit, or enable detection methods.

*Note:* A Guest Profile will not have access to these settings.

Keys:

- Press to toggle Key Detection on or off for the active User Profile. See [Loading User Profile Preferences](#).

- CONNECTED KEYS lists any devices currently linked to the active User Profile. From here, you can edit or remove existing devices, or add new ones by pressing LINK KEY FOB or LINK PHONE KEY.

Note: When adding a new phone or key fob, make sure the device is in your hand and follow the on-screen instructions.

#### Detect via Face Login:

- Press to toggle Face Login on or off for the active User Profile.
- This menu will state whether the active Profile has an appearance recorded to it. Press to ADD APPEARANCE or REMOVE APPEARANCE.

Face Login uses facial recognition to identify the driver, and then loads a matching User Profile.

#### Loading and Switching Profile Preferences

When you enter the vehicle and confirm your User Profile, you will be prompted on the right Cockpit Panel to CONFIRM loading your preferences. This includes automatically adjusting to the saved steering wheel, seat, and mirror positions.

You can set your User Profile to automatically load your preferences upon entry. See [Profile Settings](#).

#### Switching Between User Profiles



On the right Cockpit Panel, press the current avatar image, then select any User Profile from the list. Switching between User Profiles is only available when the vehicle is in P (Park).

#### Removing Secondary User Profiles

If desired, the Owner can delete existing Secondary User Profiles from the vehicle. Deleting a Profile will remove all data and preferences for that User.

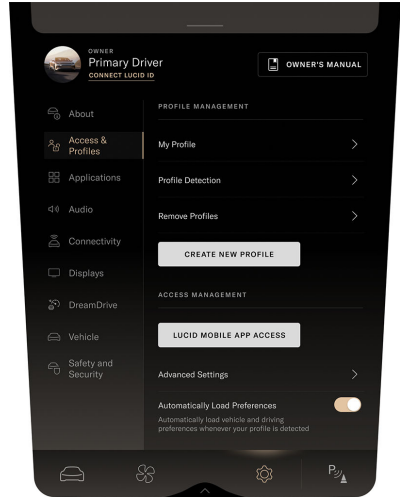
Note: Only the Owner can manage User Profiles.



1. On the Pilot Panel, press  >  Access and Profiles > Remove Profiles.
2. Press EDIT to bring up the editing screen.
3. Press DELETE next to the profile to be removed. You will be prompted to confirm your selection.

#### Factory Reset

The Factory Reset feature wipes all user profile data from the vehicle including the removal of any secondary user profiles that were created.

#### Performing a Factory Reset

Before attempting a Factory Reset the following conditions must be met:

- Lucid ID connected
- Vehicle charged to at least 20%
- Vehicle is in Park

To perform a Factory Reset, first navigate to the Access & Profiles page on the Pilot Panel:

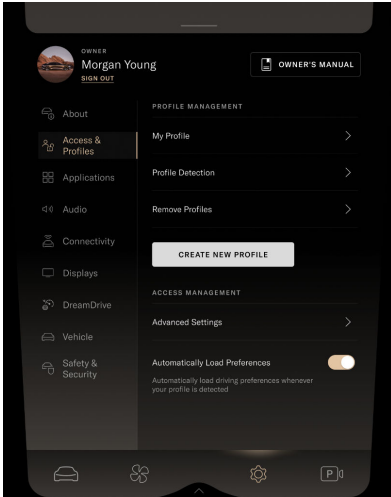

Next, select Advanced Settings. In this screen, you will find the Factory Reset Option:

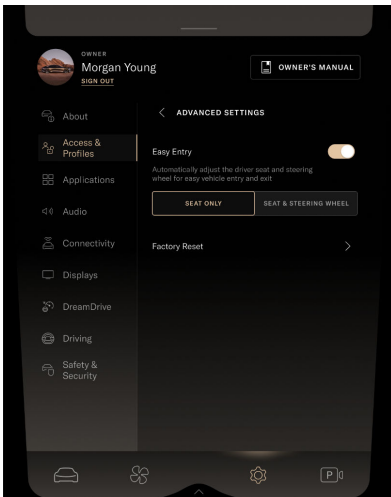

You then must confirm your decision before the reset proceeds. By selecting the toggle switch, you have the option of also clearing all cloud data as well as vehicle data.

● **CAUTION:** This step cannot be undone. All data will be lost forever.

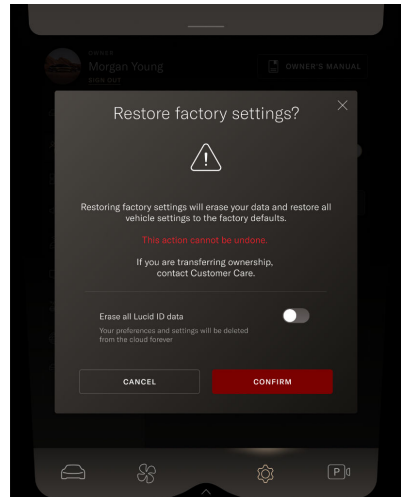

After confirmation, you will see a series of "Factory Reset in Progress" screens. When these screens disappear, the Factory Reset is complete and all data is deleted.

#### Changing Display Settings

To change the Unit of measure, Language, and Time Zone, use the Pilot Panel and select  > Displays, and then tap either Units, Time Zone, or System Language.

---

# Media and Audio

## Media Overview

---

To launch media, tap the Media icon  on the Right Cockpit Panel.

Applications displayed in the [Smart Drawer window](#) on the Right Cockpit Panel allow you to browse the contents. The Pilot Panel view of the smart drawer shows additional controls for lists and libraries.

Tap on a media item to select and play media from that source.

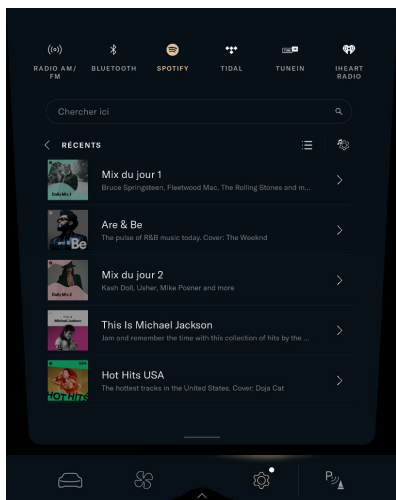
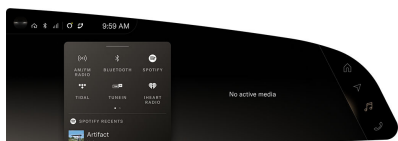

**Steering wheel media controls**

When active media is playing, or a call is in progress, use the steering wheel controls as followed:

1. **Right Toggle/Center Button:** Press the button to play/pause the media playback or to mute/unmute the radio or to answer a call. To answer an incoming call, press once. To reject incoming call, press and hold.
2. **Rocker-Up:** Toggle and hold to increase volume.
3. **Rocker-Down:** Toggle and hold to decrease volume.
4. **Previous:** Press to skip to the previous available media. When using the radio, press to scan to the previous available frequency. See [AM and FM Radio](#) on page 125.
5. **Next:** Press to skip to the next available media. When using the radio, press to scan to the next available frequency. See [AM and FM Radio](#) on page 125.
6. **Voice Assistant:** use to invoke configured voice assistant.



---

## Dashboard Volume Control

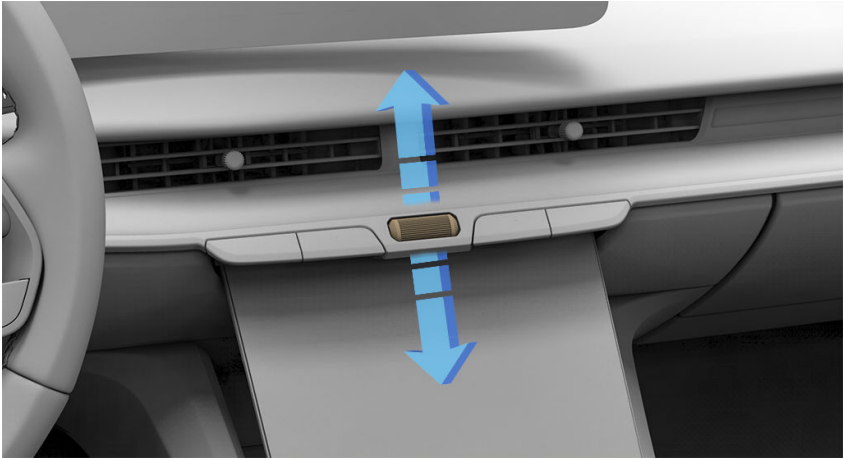

When media is playing, the toggle on the dashboard can be used adjust the volume. Scroll up to increase or down to decrease.

When media applications are opened on the Pilot Panel, use the  search bar to search for a particular song, album, artist, station, or podcast. Note that search may not be available for a particular media source.

*Note:* Search functions are not available when the vehicle is not in P (Park).

#### AM and FM Radio

### About HD Radio™

Your vehicle is equipped with a special radio receiver that can receive digital broadcasts of local AM/FM stations in addition to analog broadcasts. Many stations broadcast a digital signal that may contain additional features not found in an analog signal. For more information, visit [www.HDRadio.com](http://www.HDRadio.com).

HD Radio Technology manufactured under license from iBiquity Digital Corporation. U.S. and Foreign Patents. For patents see <http://dts.com/patents>. HD Radio and the HD, HD Radio, and "ARC" logos are registered trademarks or trademarks of iBiquity Digital Corporation in the United States and/or other countries.

Lucid and iBiquity Digital Corp are not responsible for the content sent using HD Radio™ technology. Content may be changed, added or deleted at any time at the station owner's discretion.

### Using the AM/FM Radio application

Launch the AM/FM Radio application from the Right Cockpit Panel. Tap the Media icon  > AM/FM Radio from the launcher menu, then select AM/FM from the Smart Drawer.

From the main menu, you can select the desired category of radio stations.

On the right Cockpit Panel, press  > AM/FM Radio. Selected media will display, along with player controls.

- Press the  favorites icon to add the current station to your Favorites list. The icon is solid when a station has been added to Favorites.

- When listening to an HD Radio station, the  icon is highlighted. Tap a channel number to switch stations.

HD Radio stations have a multicast indicator (1 2 3...). These numbers will appear if the current station has multiple digital broadcasts. Press Seek Up or Down button repeatedly to access the other digital broadcasts or tap a channel number to switch stations. The numbers that are highlighted signify available digital channels where new/different content is available. HD1 will signify the main programming service and is available in analog and digital broadcasts. Any additional multicast stations (HD2-HD8) are only broadcast digitally.

### HD Radio Reception Factors

**Reception Area:** If you are listening to a multicast (HD2, HD3, etc.) station and you are on the fringe of the reception area, the station may mute due to weak signal strength. If you are listening to HD1, the system will simply switch to the analog broadcast until the digital broadcast is available again.

However, if you are listening to any of the possible multicast (HD2-HD8) channels, the station will mute and stay muted unless it is able to connect to the digital signal again. While in this state, the "swirl" icon will appear for a few seconds. If it is not able to reconnect to the digital signal, then the screen will be cleared and text 'station unavailable' will appear in artist and title field area

**Station Blending:** When a HD1 station is received, the system will play the analog audio broadcast from the station for a few seconds and then, if the receiver verifies the station is an HD Radio station, it will transition to play the digital audio broadcast. Depending on the station quality, you may hear a slight sound change when the station transitions from analog to the digital broadcast. The shift from analog to digital or digital back to analog sound is known as 'blending'.

**Station Issues:** In order to provide the best possible experience, a contact form has been developed to report any station issues found while listening to a station broadcasting with HD Radio technology. Every station is independently owned and operated. These stations are responsible for ensuring all audio streams and data fields are accurate. This

form can be found at: <https://hdradio.com/stations/feedback/>

### Troubleshooting HD Radio

The table below describes how to troubleshoot certain issues.

Experience	Cause	Action
Mismatch of time alignment a user may hear a short period of programming replayed or an echo, stutter or skip.	The radio stations analog and digital volume is not properly aligned or the station is in ballgame mode.	None, radio broadcast issue. A user can contact the radio station.
Sound fades, blending in and out.	Radio is shifting between analog and digital audio.	Reception issue, may clear up as the vehicle continues to be driven. Turning the indicator of the "HD Radio" button off can force radio in an analog radio.
Audio mute condition when an HD2/HD5 multicast channel has been playing.	The radio does not have access to digital signals at the moment.	This is normal behavior, wait until the digital signal returns. If out of the coverage area, seek a new station.
Audio mute delay when selecting an HD2/HD5 multi-cast channel preset.	The digital multicast content is not available until HD Radio broadcast can be decoded and make the audio available. This takes up to seven seconds.	This is normal behavior, wait for the audio to become available.
Text information does not match the present song audio.	Data service issue by the radio broadcaster.	Broadcaster should be notified. Complete the form: <a href="https://hdradio.com/stations/feedback/">https://hdradio.com/stations/feedback/</a> .

Experience	Cause	Action
No text information shown for the preset selected frequency.	Data service issue by the radio broadcaster.	Broadcaster should be notified. Complete the form: <a href="https://hdradio.com/stations/feedback/">https://hdradio.com/stations/feedback/</a> .

### Logging into Media Applications

Many third-party media applications can be logged into via the Pilot Panel, allowing you to directly control and personalize your apps.

On the Pilot Panel, select  >

 Applications for a list of available third-party media.

*Note:* Many third-party media applications require a data connection and login information, and some services are subscription-based. Refer to the provider for more information.

### Playing Media from Devices

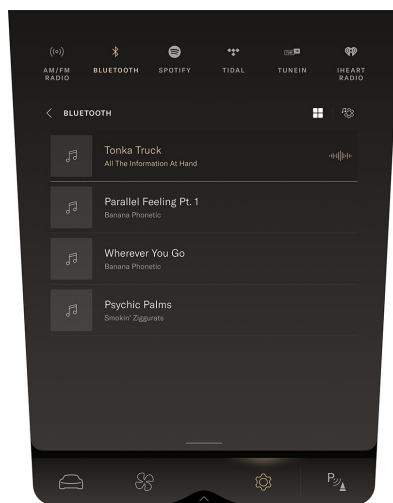

The infotainment system can play media from Bluetooth® connected devices (see [Pairing a Bluetooth Device](#) on page 134). From the list of media applications on the right Cockpit or Pilot Panel, select Bluetooth® source.



---

## Audio Settings

---

To access the audio settings on the Pilot Panel, select  >  Audio.

- Equalizer: Adjusts the bass, mid, and treble
- Balance: Adjusts the sound level between the speakers
- Volume: Adjusts the master volume, as well as the volume levels for the navigation system and phone

---

# Using Alexa

Alexa Built-In

---

## Overview

The Lucid Air comes equipped with Amazon Alexa Built-In allowing users to give voice commands for navigating to destinations, making phone calls, sending and receiving text messages, playing music, adjusting temperature and controlling smart home devices.

## Authentication

To sign in to Alexa:

1. From the Pilot Panel, go to Settings > Applications > Alexa.
2. On your mobile device, go to [amazon.com/code](https://amazon.com/code) and enter in the 5-character code or scan the QR code displayed on the Pilot Panel.
3. If you've connected a mobile device, you will be prompted to enable Alexa to access contacts and read messages.
4. If you've not previously connected a mobile device, you will be shown see the Alexa Settings screen.

## Invoking Alexa

You can invoke Alexa in one of two ways:

- Pressing the voice button on the steering wheel.
- Saying "Alexa."

## Things to Try with Alexa

Once signed in, you can go to Settings > Applications > Alexa > Things to Try to see a list of sample Alexa commands.

## Calling and Messaging Setup

1. Ensure your phone is paired and connected under Settings > Connectivity > Bluetooth and tap on the ellipsis to access phone options.
2. Turn on the "Sync Messages" and "Sync Contacts" toggles – this allows the Dialer app to gain access to the messages and contacts on your phone.
3. Turn on the "Allow Alexa to Access Contacts" and "Allow Alexa to Read Messages" toggles – this allows Alexa to gain access to the messages and contacts from the Dialer app.
4. Alternatively, go to Settings > Applications > Alexa > Settings > Communication and ensure the toggles are turned on.

# Maps and Navigation

## Navigation Overview

To access navigation, press the  icon on the right Cockpit Panel. This screen will display your current location and street name (where applicable).

If you pan away from the current location, the street name will be replaced by a Recenter button. Touching Recenter is a quick way to return to the default view showing the current position.

*Note:* Upon first use of the navigation system by a User Profile, that user will receive a prompt and must read and agree to the Terms and Conditions before proceeding.

The smart drawer can expand the Navigation screen into the Pilot Panel for additional details menus not available in the smaller Cockpit Panel.

## Navigation Settings



On the Pilot Panel, press the  icon on the Navigation screen to configure navigation options, including:

- **Offline Mode:** Nav App Settings now has an Offline mode if Users are concerned about Privacy. GPS will still be available, but you will not be connected to a server. Before using this mode, you must first download maps to use in Offline mode.

- **Downloadable Maps:** Users can now download one or more states or provinces at a time.

Downloadable maps are used when connectivity is lost. You can also pause and resume a download to control what gets downloaded and when.

*Note:* When connectivity is lost, and when using only downloaded maps, the number of Points of Interest for Search is more limited, and the route is no longer an EV Route - it won't auto-add charge stops if needed.

- **Personal Data:** The navigation system collects personal location data to improve your trip recommendations. If you wish to permanently delete your personal data, such as when you sell your vehicle, you may do so from this screen.

*Note:* Only a Primary User can Accept/Reject Terms and Conditions or delete downloaded maps. If the Primary User declines Terms & Conditions, navigation stops working for all users until Terms and Conditions are accepted.

Anonymous Longitude/Latitude data is shared with our navigation service partner to enable Search and Routing, but personal data is saved locally. Both Primary or Secondary users can delete their own data. After deleting, navigation still works but Home, Work, and destination history is erased.

*Note:* Deleting personal location data cannot be undone. Lucid does not store a copy of this data.

To navigate to a location, open the smart drawer on the right Cockpit Panel to select a destination. Use Alexa voice commands to navigate hands-free. Tap the search icon to choose from one of the search category shortcuts or recent destinations and search terms.

Move the smart drawer into the Cockpit Panel to access additional options:

- Use the Search bar to type in an address via the on-screen keyboard.
- You can also select one of the six categories. Swipe left or right to view additional categories.
- You can also make your own shortcuts for HOME and WORK: Select from your saved home and work locations. See [Setting Home and Work Destinations](#) on page 132.
- When you tap the search bar, by default you will see RECENTS: Select from a list of recently-used destinations or search terms. If you start typing something, those will be replaced with search matches.
- Search this Area (at another location on the map if you pan the map)

When routing, you have 2 additional ways to search:

- Along The Route
- Near Destination

### Charging Category Search

From the main Navigation smart drawer, tap the CHARGING category to view nearby charging stations. Where possible, these include plug type and availability information (requires data connectivity).

The default view shows nearby Electrify America DC fast chargers above 150 kilowatts, which provide the best charger user experience. There is a switch to turn off Electrify America only, to see a mix of nearby charging providers.

You can also manually Sort and Filter based on criteria like availability, distance, power, plug type, or charging vendor (such as Electrify America).



### Routing

All Lucid routes are EV routes. Lucid EV routes are integrated with your vehicle range and consumption profile. It considers not just the current state of charge, road profile, temperature, Heating, ventilation, and air conditioning (HVAC) and traffic conditions, but it also predicts your unique vehicle consumption over time under those conditions.

Once a location is specified, the map will display an overview of the proposed route on both the ICR and the CID. Up to 3 Route Options will be shown, each with its own written summary and visual display on the map. The recommended top option is the Fastest route (least time spend driving), and it will be shown on the map in blue. The other alternative suggestions will also be shown on the map but in gray. Traffic conditions on each route will be included. If charge stops are required, they will be auto-added to all 3 routes and will be displayed on all 3 routes.

Before you tap GO, you can preview and plan your route on the MY ROUTE screen, which will show up to three route options including the estimated time of arrival (ETA),

total distance, and traffic conditions along the route. If the route requires charging stops to reach the destination, then charging stops will automatically be added and shown on this screen as well.

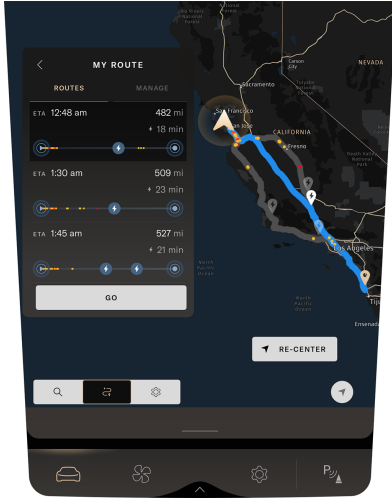

**Note:** Because the Auto-add Charging feature is enabled by default, the system automatically calculates the battery power needed for the trip and the recommended charging time for each charging stop.

Once the route has started, the turn-by-turn guidance instructions are shown on the top navigation screen. Lane guidance, exit numbers, and other guidance details will be displayed when appropriate. While routing, if the navigation is replaced with media or phone, navigation instructions will remain in view in the Center Cockpit Panel while a route is in progress.

The MANAGE tab summarizes the stops and their specific details. The DETAILS tab lists every turn and stop along your route.

When the system automatically adds charging stops, extra details are provided for each stop such as estimated percent on arrival, suggested plug type to use, suggested number of minutes to charge for, and suggested minimum percent to charge up to. This information will persistently show in both the DETAILS tab and the MANAGE tab until your route ends. You can also tap each Waypoint on

the Route directly from the map view to see more details.

When starting a trip, we initially show you in the smart drawer a full list of instructions. This list automatically minimizes after thirty seconds, to use the full screen for viewing your maps and route. The route will display all of your stops and traffic conditions. The smart drawer with the list of instructions and details about your stops can be manually reopened. You can add, reorder, or delete stops.

If at any point you deviate from the route, the system will quickly and automatically recalculate a new route and immediately give new guidance instructions.

While routing, if you have to stop and turn off the vehicle, and you come back and turn on the vehicle, the route will continue to be present on the screen.

Press END or use voice commands ("Alexa, cancel navigation") to end navigation.

The Lucid navigation system will periodically check that predicted charge on arrival is still correct. It checks everytime you finish charging, everytime you reach a low state of charge, and every fifteen minutes while routing. If the EV routing conditions have significantly changed and the route needs to be refreshed, a notification will appear and will ask you to agree to a new route.

If for some reason the EV route requires charging, but a fast charger could not be automatically added along the route, then an Insufficient Charge notification will be shown inside navigation. In this case, we recommend that you manually search for charging. Usually, slow chargers can be found along the route and can be used.

**Note:** When Routing starts, a Mute button will appear on the top navigation screen, which enables you to turn off the audio guidance.

#### Adjusting the Map

The maps on either the ICR and CID screen can be individually rotated, panned, or zoomed in and out via the touchscreen. Any time the map is manipulated beyond your vehicle's current position, the RE-CENTER button will appear; tap it to return to your current position.



To zoom in the map, use one finger to double tap the touchscreen. To zoom out the map, use two fingers to tap the touchscreen. To see a 3D view of the map, swipe two fingers on the touchscreen.

The map centers around your current location by default, and the current street name is displayed.

The Pilot Panel and Cockpit Panel can maintain their own independent map setting and zoom level while routing or not routing. Touch the icon in the lower right of the map to change default views:

- Range Map: Shows the approximate range that can be traveled using your current level of charge
- 3D Track-Up: 3D view that tracks your vehicle's current position
- 2D Track-Up: 2D view that tracks your vehicle's current position
- North-Up: 2D view where North is always at the top of the map
- Route Overview: Displays your current route

Once you start manually interacting with map, these default views are ignored, and the system will maintain your personal User Mode until you select one of the default views listed above again.

*Note:* The Route Overview option only appears when a route is selected.

The map contains features such as real time traffic, realistic 3D landmarks, and points of interest. The points of interest can be tap selected from the map to see details and make a route to them. You can also tap a random place on the map to see their coordinates and make a route to that point.

In the Navigation app settings, it is also possible to turn on and off Traffic and Satellite maps.

#### Predicting Energy Usage

The Auto-add Charging feature is always on and will help anticipate the vehicle's charging needs for a trip. This feature automatically

adds charging stations to a calculated route as needed.

### Using Range On Map

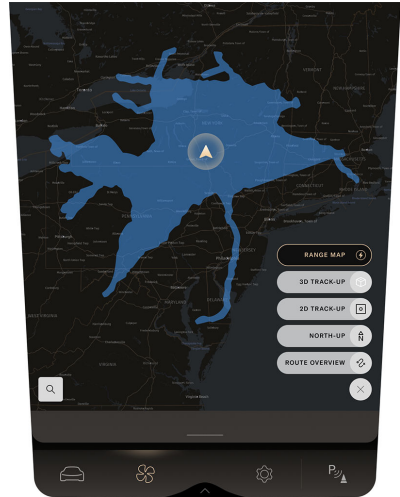

The Lucid Range On Map provides a visual representation of anticipated range for the given battery state of charge, traffic conditions, elevation changes, and more. To display the Range On Map, select the feature using the map controls.



#### Setting Home and Work Destinations

Common destinations such as your home or workplace can be designated accordingly in the system, allowing you quick access within the Navigation menus.

When destination details are displayed in the smart drawer, press an option to

 Set as Home or  Set as Work. Home and Work locations can also be set using voice commands and in Vehicle Settings.

The applicable icon will appear next to the destination under its details.

Once a destination is set in this manner, the option under its details will change to Remove.

When a data connection is present, the "self-healing maps" are updated automatically over the air with no user intervention as they become available.

When your vehicle does not have an available wireless internet connection, the navigation system will pull from any existing map data that was automatically downloaded and stored by the vehicle based on driving and search history. Any resulting information displayed will be labeled as OFFLINE RESULTS, and will not include live traffic conditions, EV-style routing, charge plug availability.

---

# Phone and Smart Devices

## Bluetooth® Wireless Technology

---

When in operating range, you can pair a Bluetooth-capable phone with your vehicle for hands-free use. Bluetooth usually supports a wireless connection of approximately 30 feet (9 m), although range can vary based on atmospheric conditions and the device used.

To use your phone with the vehicle, you must pair it first. See [Pairing a Bluetooth® Device](#).

Two devices can be connected simultaneously. For example, if you own a personal phone and wish to stream music while taking calls from your work phone, you can connect a first device for phone features, and second device for media, or the same device can be connected for both phone and media. Only one device can be connected for each feature.



*Note:* Other Bluetooth-capable devices can also be paired to your vehicle for use, such as an iPad or Android tablet.

## Pairing a Bluetooth Device

---

Pairing a phone to your vehicle enables you to place and receive hands-free calls, and to access your phone's contacts, messages, and recent call list. It also allows you to play media from various media apps from your device. Once a phone is paired to the vehicle, it will automatically connect whenever it is in range.

To pair a device, have it with you in the vehicle and ensure it has Bluetooth® enabled and discoverable, then follow these steps:

1. On the Pilot Panel, select  >  Connectivity > Bluetooth.
2. When Bluetooth is enabled from the vehicle, this screen will scan for Bluetooth enabled devices within range. Under OTHER DEVICES, tap the device to be paired.

*Note:* Pairing must be initiated from the vehicle, and cannot be done from your device.

3. When prompted, press CONFIRM if the pairing code on the screen matches the one on your device.
4. If prompted by your device, select whether to allow access to your contacts and messages.
5. After pairing is complete, you can change device settings to enable phone, media, or both.

When paired successfully, the name of the device will be listed under CONNECTED DEVICES.

## Syncing Contacts and Messages

---

Once a phone is paired, you can configure access to phone contacts and messages, allowing you to make calls and display messages from contacts stored in your phone. Follow these steps:

1. On the Pilot Panel Bluetooth screen, press the three dots by a connected device.
2. From this screen, you can toggle the options to sync messages and contacts. Please note that larger contacts lists can take more time to sync with the vehicle. To sync your messages, go to your mobile device's Bluetooth settings and make sure you have allowed text message notifications. Press SAVE to keep these settings and return to the previous screen.

## Connecting and Disconnecting Bluetooth Enabled Devices

---

When a paired phone enters or exits the range of your vehicle, it will connect or disconnect automatically. If you wish to connect to a different paired device:

1. On the Pilot Panel Bluetooth screen, press Disconnect.
2. Press the DISCONNECT button next to the device to be disconnected.
3. Press DONE when you have finished disconnecting any unwanted devices.

4. Under MY DEVICES, tap the name of the device to be connected.

Alternately, you can use the right Cockpit Panel. Press the  icon in the status bar to display connected devices and connect or disconnect.



#### Editing Bluetooth Enabled Device Preferences

To edit device preferences:

1. On the Pilot Panel Bluetooth screen, press the three dots by a connected device.
2. From this screen, select to allow your vehicle to access the phone, audio, or both features. Press SAVE to keep these settings and return to the previous screen.

If you no longer wish to use a device with the vehicle:

1. On the Pilot Panel Bluetooth screen, press Forget.
2. Press the FORGET button next to any device you wish to remove, then press FORGET at the prompt to confirm.
3. Press Done when you have finished unpairing any unwanted devices.

#### Using the Phone App

- **WARNING:** Distracted driving can lead to loss of vehicle control and a collision, which can result in serious injury or death. Lucid strongly recommends that the driver stay focused on the road at all times while driving. Safe operation of the vehicle is the driver's primary responsibility.
- **WARNING:** Always ensure you are following all applicable local laws regarding the use of phones while driving. This includes, but is not

limited to, laws that prohibit texting and require hands-free phone operation at all times.

Tap the  phone icon on the right Cockpit Panel to open the Phone smart drawer.

When needed, the Phone smart drawer can be opened on the Pilot Panel to show more detailed lists and information.

- **CONTACTS:** Displays a synced contact list. See [Syncing Contacts and Messages](#). Contacts can be searched and sorted on the Pilot Panel.
- **DIALPAD:** Opens the dialpad for making manual calls.
- **FAVORITES:** Displays a synced list of favorite contacts.
- **MESSAGES:** Allows you to have text messages read aloud and send preset text messages. See [Using Messages](#).
- **MOST DIALED:** Displays a list of frequently dialed numbers.

#### Making and Receiving Phone Calls

To make a phone call, do any of the following:

- Select a contact from the CONTACTS, FAVORITES, MOST DIALED, or RECENT CALLS lists.
- Use the DIALPAD screen to manually dial a number.

*Note:* If it is safe and legal to do so, you may also make a call using the phone you have paired to your vehicle.

#### Receiving a Call

Incoming calls from a paired phone will display an alert on the right Pilot Panel. If your phone contacts have been synced to the vehicle, any contact information for that caller will be displayed. See [Syncing Contacts and Messages](#) on page 134.

*Note:* For iPhone users:

- If you take the call from the car system, the call audio will always be routed through the car system.

- 
- If you take the call from your iPhone, the call audio will depend on iPhone "Call Audio Routing" setting.

Press an option on the touchscreen or use the steering wheel controls to DECLINE or ACCEPT the call.

*Note:* Your phone may prompt you to select the audio output for the call, depending on the type of phone and last output used.

The "Call Audio Routing" Setting on iPhone

The "Call Audio Routing" setting can be configured in one of three ways:

- Automatic - The iPhone routes the audio to the phone even though the phone is connected to the car via Bluetooth.
- Bluetooth Handset - The iPhone routes the audio to the car when the phone is connected to the car via Bluetooth.
- Speaker - The iPhone routes the audio to the phone speaker even though the phone is connected to the car via Bluetooth.

#### In-Call Options

---

Active calls are displayed on the right Cockpit Panel.

- The  active call icon will be displayed in the status bar when a call is in progress.
- Contact information and call length will be displayed in the main screen, along with call control buttons.

If a call is placed on hold and a second call is made, the call control buttons change.

- Press Swap to switch between the active call and the call on hold.
- Press Merge to bring both callers into a shared call.

Call volume and the mute option can be controlled with the physical controls in your vehicle. See [Physical Media Controls](#) on page 123.

#### Using Messages

---

- **WARNING:** Distracted driving can lead to loss of vehicle control and a collision, which can result in serious injury or death. Lucid strongly recommends that the driver stay focused on the road at all times while driving. Safe operation of the vehicle is the driver's primary responsibility.
- **WARNING:** Always ensure you are following all applicable local laws regarding the use of phones while driving. This includes, but is not limited to, laws that prohibit texting and require hands-free phone operation at all times.

Tap the  phone icon on the right Cockpit Panel to open the phone smart drawer and select MESSAGES.

Unread messages will be indicated by a dot, which will disappear once a message is played back. Press a message to have it read aloud, and press again to stop playback.

To send a new message, press the  compose icon. Select the recipient and the preset message, then press SEND.

#### Incoming Messages

Incoming messages from a paired phone will display an alert on the right Pilot Panel. If your phone contacts have been synced to the vehicle, any applicable contact information will be displayed. See [Syncing Contacts and Messages](#) on page 134.

Press an option on the touchscreen or use the steering wheel controls to PLAY the message, CALL the sender, or REPLY with a preset message.

# Connecting the Vehicle to Wi-Fi®

## Add a New Wi-Fi Network



---

### Add a Wi-Fi Network

Your vehicle can connect to a Wi-Fi network to send and receive data, which is often faster than cellular networks. Lucid recommends leaving Wi-Fi enabled and connected to a network whenever possible to receive software updates in a timely manner.

*Note:* Connecting to a Wi-Fi network may result in large amounts of data being transferred to/from the car. Lucid is not responsible for any overages or charges related to Wi-Fi usage.

To connect to a network:

1. On the Pilot Panel, select  >  Connectivity > Wi-Fi®.
2. When Wi-Fi is enabled, the system scans for available networks in range. Under OTHER NETWORKS, select the network you wish to use, enter a password if prompted, and press JOIN.
3. If the connection succeeds, the name appears under CONNECTED NETWORK.

Added networks not currently connected are listed under SAVED NETWORKS. Tap a network name to connect to it.

### Edit or Remove a Wi-Fi Network

1. Press the three dots next to a network to view its properties.
2. From here you view network information, or press FORGET NETWORK to remove it from your list.

### Wi-Fi Quick Access

On the right Cockpit Panel, press the status bar to expand it, then press the  Wi-Fi icon to open its menu.

From this menu, you can:

- Toggle Wi-Fi on/off

- View the currently connected network
- Press to switch to a saved network
- Press Wi-Fi Settings to open that screen on the Pilot Panel

---

# HomeLink

What is HomeLink?

---

HomeLink is a wireless control system that enables you to remotely operate up to 15 Radio Frequency (RF) devices, such as garage doors, gates, lights, and home security systems.

Additional system information can be found online at [www.homelink.com](http://www.homelink.com).

HomeLink FCC/ISED Advisory

---

## FCC (USA) and ISED (Canada)

This device complies with FCC rules part 15 and Innovation, Science, and Economic Development Canada RSS-210. Operation is subject to the following two conditions:

(1) This device may not cause harmful interference, and (2) This device must accept any interference that may be received including interference that may cause undesired operation. **WARNING:** The transmitter has been tested and complies with FCC and ISED rules. Changes or modifications not expressly approved by the party responsible for compliance could void the user's authority to operate the device.

1. This device may not cause harmful interference,
2. This device must accept any interference that may be received including interference that may cause undesired operation.

- **WARNING:** The transmitter has been tested and complies with FCC and ISED rules. Changes or modifications not expressly approved by the party responsible for compliance could void the user's authority to operate the device.

This equipment complies with FCC and ISED radiation exposure limits set forth for an uncontrolled environment. End Users must follow the specific operating instructions for satisfying RF exposure compliance. This transmitter must be at least 20 cm from the

user and must not be co-located or operating in conjunction with any other antenna or transmitter.

## FCC (États-Unis) et ISED (Canada)

Cet appareil est conforme aux règlements de la FCC, section 15, et au CNR-210 d'Innovation, Sciences et Développement économique Canada. Le fonctionnement est assujéti aux deux conditions suivantes : (1) cet appareil ne doit pas causer d'interférences nuisibles et (2) cet appareil doit accepter toute interférence reçue, y compris celle qui pourrait entraîner un dysfonctionnement. **MISE EN GARDE :** L'émetteur a subi des tests et est conforme aux règlements de la FCC et d'ISDE. Les changements ou modifications non approuvés explicitement par la partie responsable de la conformité pourraient rendre caduque l'autorisation de l'utilisateur de se servir du dispositif.



Cet appareil est conforme aux limites d'exposition aux radiations de la FCC et d'ISDE établies pour un environnement non contrôlé. Les utilisateurs finaux doivent respecter les instructions d'utilisation spécifiques pour satisfaire aux exigences de conformité aux expositions de RF. L'émetteur doit se trouver à 20 cm au minimum de l'utilisateur et ne doit pas être situé au même endroit que tout autre émetteur ou antenne ni fonctionner avec un autre émetteur ou antenne.

Programming HomeLink

---

- **WARNING:** Do not use HomeLink with any garage door opener that cannot detect an object and signal the door to stop and reverse as required by U.S. Federal Safety Standards (including any garage door opener manufactured before April 1st, 1982). A garage door opener which does not have the safety stop and reverse feature does not meet current federal safety standards. Using a garage door opener without these features increases the risk of serious injury or death.



To set up a new HomeLink program, have the remote for the garage door or gate you are programming ready, and follow these steps:

1. On the Pilot Panel, select  >  Connectivity > HomeLink, then press + ADD NEW HOMELINK.  
*Note:* Press CANCEL during any step of programming to return to the main HomeLink® screen. No information will be stored.
2. Use the on-screen keyboard to enter a name for your HomeLink®, then press CONTINUE.
3. Prepare your surroundings as instructed on the screen, and press CONTINUE when you are ready to proceed.  
*Note:* Select Program with D-Mode only if your device requires D-Mode programming per the HomeLink website or operator's manual.
4. To record the remote signal, press and hold the remote 2 in (5 cm) below the letter L on the front of your vehicle until the horn sounds and the headlights flash.
5. Once the Pilot Panel shows that recording is completed, press CONTINUE.  
*Note:* If the on-screen process detects that your device uses a fixed code, it will automatically skip this step and proceed to the test in the next steps.
6. To train the receiver, press the LEARN button on the back of your receiver (removing the cover if needed), then press CONTINUE on the Pilot Panel.  
*Note:* Because pressing the LEARN button is time-sensitive, a second person can assist with this step.  
*Note:* If your receiver is QuickTrain compatible, you can press CONTINUE.  
*Note:* After pressing the 'LEARN' or sync button, you will have 30 seconds to test HomeLink. If a signal is not detected within the timeout period, an error message will be displayed with the option to try again.
7. To test, press the TEST HOMELINK button. You will need to press this three

times in total. Wait until you see a check mark before pressing the button a second and third time.

8. During each brief test, the TEST HOMELINK button will be temporarily unavailable, while the current test number animates to indicate it is in progress.  
*Note:* The device you are programming may respond during any of these three tests. Continue with all three tests.
9. After a test completes, a check replaces the number and the TEST HOMELINK button becomes available. Continue through all three tests.
10. After all three tests have completed, the screen will prompt you to confirm whether the device responded. Press YES or NO.  
*Note:* Pressing NO will give you the option to restart the test and contact information for HomeLink Help.
11. If you pressed YES, you will be brought back to the Connectivity screen. Your new HomeLink device will be listed under CONNECTED DEVICES.

### Reprogramming a device

1. On the Pilot Panel, select  >  Connectivity > HomeLink, then select the device to be reprogrammed.
2. On the device details screen, press PROGRAM.
3. Follow the steps for programming a device. See [Programming Homelink](#).

### Using HomeLink®

Once devices have been programmed to your vehicle, they can be accessed using the HomeLink menu on the right Cockpit Panel.

The HomeLink menu will open automatically when the vehicle is detected within 82 ft (25 m) of a programmed garage door or gate. To access it manually:

1. Press the status bar to expand.
2. Press  to open HomeLink.



---

From this menu, you can:

- Press + ADD NEW HOMELINK to add a new device. See [Programming HomeLink](#).
- Press HOMELINK SETTINGS to edit or remove existing devices. See [Renaming or Deleting a Device](#).
- Press a device name to activate it.



The  icon next to a device indicates that a signal has been sent to the door or gate. The menu automatically collapses 3 seconds after a signal is sent.

#### Renaming or Deleting a Program



---

*Note:* For your security, it is recommended to delete all programmed devices upon the sale or lease termination of your vehicle.



#### Renaming a program

1. On the Pilot Panel, select  >  Connectivity > HomeLink, then select the device to be renamed.
2. On the device details screen, press the  edit icon.
3. Use the on-screen keyboard to edit the device name, then press SAVE to confirm, or CANCEL to return to the previous screen.

#### Deleting a program

1. On the Pilot Panel, select  >  Connectivity > HomeLink, then select the device to be removed.
2. On the device details screen, press DELETE.
3. The screen will prompt to confirm whether you wish to delete the selected device. Press DELETE ALL to confirm, or CANCEL to return to the previous screen.

#### Deleting all programs



1. On the Pilot Panel, select  >  Connectivity > HomeLink.

2. If two or more devices are connected to your vehicle, the option to DELETE ALL will be available. Press it to continue.
3. The screen will prompt to confirm whether you wish to delete all connected HomeLink® devices. Press DELETE ALL to confirm, or CANCEL to return to the previous screen.

# Vehicle Information

## Vehicle Identification Number



---

On the Pilot Panel, select  >  About Vehicle to view the VIN.

## Direct Access to the Owner's Manual

---

You can access the Owner's Manual via the Pilot Panel under Settings. The Owner's Manual periodically updates with the latest information as long as the vehicle has internet connectivity.

Select  >  About Vehicle on the Pilot Panel, then press the OWNER'S MANUAL button.



*Note:* You can also view the Owner's Manual with the Lucid mobile app.

## Alerts and Notifications

---

- **WARNING:** Read all alerts and notifications carefully and follow any provided instructions as soon as possible. Do not drive the vehicle if you are cautioned not to do so.

Important system alerts and notifications that appear on the Cockpit Panel will also be saved under the About Vehicle screen on the Pilot Panel for later reference.

On the Pilot Panel, select  >  About Vehicle to view any current alerts and notifications.

*Note:* A dot on the  About Vehicle icon indicates a new alert or notification. The indicator will disappear once the alert or notification has been reviewed.



If you are unsure of how to resolve an alert or notification, contact your Lucid Customer Care for assistance.

# Software Updates

## Updating Software

Your vehicle supports wireless software updates, giving you continued access to new features and improvements. Lucid recommends installing these updates as soon as they become available.

### Current Software Version

On the Pilot Panel, select  >  About Vehicle to view the current software version. Press Learn More next to a version to read the release notes.

### Prerequisites for updates

- Your vehicle must be shifted into P (Park) before starting an update.
- Because some updates can take a few hours to install, the vehicle battery must be charged to at least 20% before installation. See [Charging the Vehicle](#) on page 149.

*Note:* Charging is paused during the update installation process.

- Ensure that your vehicle is connected to Wi-Fi® and has a strong signal in order to receive updates quickly and uninterrupted. See [Add a New Wi-Fi Network](#) on page 137.
- During the update, you will not be able to lock or unlock the vehicle, access the screens, or drive.
- Guest Users are not able to install or schedule updates. See [About User Profiles](#) on page 118.

- **CAUTION:** All occupants must exit the vehicle before the update. Once the update starts, you will not be able to lock or unlock doors.

### Update notifications

When a software update becomes available, you should receive notifications in three ways:

1. A push notification will be sent to the Lucid mobile app.

*Note:* This notification will only be received if push notifications are enabled on your mobile device.

2. A notification will display on the right Cockpit Panel when your vehicle is shifted into P (Park).



If the update is not installed within 24 hours from the first notification, then notifications continue once per day at the start of the first trip of the day.

Press REMIND ME LATER to postpone the notification for 8 hours. Press REVIEW UPDATE to continue with the update process on the Pilot Panel.

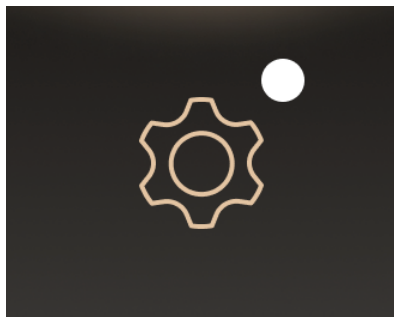
3. On the Pilot Panel, a notification badge will appear on the  icon. Once the update is installed, the badge will disappear.



### View available Update

On the Pilot Panel, select  >  About Vehicle. If a software update is available, a notification badge will appear on the  About Vehicle icon. The update information, estimated installation time, and options will be displayed.

**Schedule an update**

On the software update screen, press SCHEDULE TIME if you wish to start the update later. Updates can be scheduled up to 48 hours later.

1. Read the cautionary statement and press CONFIRM to consent to the update.
2. Select the time to start on the screen provided and press SET TIME to save.
3. Your scheduled date and time will be displayed on the main software update screen, and can be edited by pressing the  icon beside it. Ensure that all update prerequisites will be met at the scheduled time.

30 minutes before a scheduled update, you will receive a notification on the right Cockpit Panel, with options to DELAY AN HOUR or CANCEL SCHEDULE.

**Install an update now**

On the software update screen, press INSTALL NOW to proceed with the update.

1. Read the cautionary statement and press CONFIRM to consent to the update.
2. The system will perform a series of checks to ensure all prerequisites have been met.
3. A 2-minute countdown will display. Exit and lock the doors at this time. See [Doors](#) on page 20.
4. During the update, the Pilot Panel and left Cockpit Panel screens will be blank. The Cockpit Panel indicates the update is proceeding. The progress can be viewed on the right Cockpit Panel and within the Lucid mobile app.
5. When the update is complete, a notification will appear on the left Pilot Panel and a push notification will be sent to the Lucid mobile app.



*Note:* If an update fails to install, a notification will display on the Infotainment screens and a push notification is sent to the Lucid mobile app.

- If a failure was due to a prerequisite not being met (e.g., battery was at less than 20% or vehicle was not put in Park), resolve the issue and press TRY AGAIN.
- If a failure was due to another reason, contact a Lucid Service Center for assistance.

Viewing Release Notes

Lucid strongly recommends that all users read the release notes for every software update. They can contain important information about your vehicle, including safety information or new operating instructions.

Release notes can be viewed before and after a software update:

- On the Pilot Panel, select  >  About Vehicle. The software versions for the current installation and any available updates will be listed. Press Learn More next to a version to read the notes for it.
- When an update has installed successfully, press Learn More on the prompt that appears on the right Cockpit Panel.

# High-Voltage Battery Pack & Charging

# Electric Vehicle Components

## High-Voltage Components

- **WARNING:** The high-voltage system in this vehicle has no user-serviceable parts. Do not disassemble, remove, or replace high-voltage components, connectors, or cables. High-voltage cables are colored orange for easy identification.
- **WARNING:** In the unlikely event that a fire occurs, exit the vehicle and immediately contact your local fire emergency responders.
- **WARNING:** For your safety, always read and follow the instructions and warnings written on all labels attached to your vehicle.

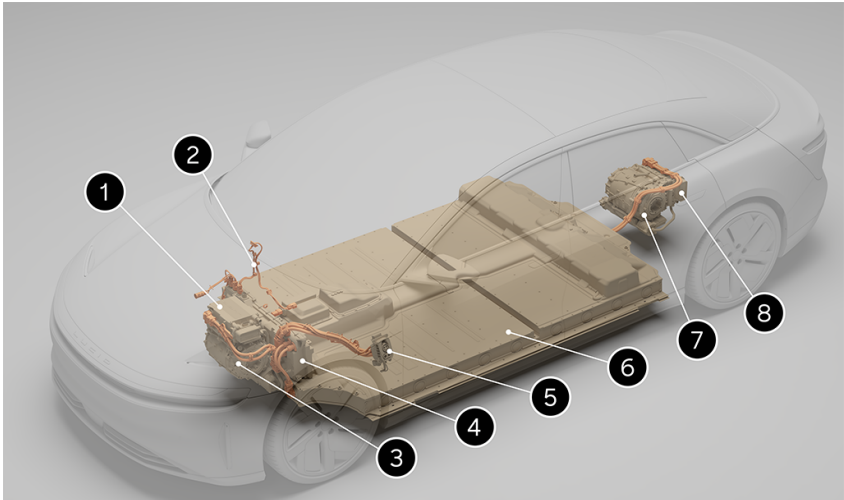

1. Front Inverter
2. High-voltage cables (not all high-voltage cables are shown)
3. Front Drive unit
4. Wunderbox
5. Charge port
6. Battery pack
7. Rear drive unit
8. Rear inverter

---

 This symbol can be found on high-voltage components and indicates risk of electrical shock.

# Battery Information

## About the Vehicle Batteries

- **WARNING:** Only a Lucid Service Center should service the high-voltage battery pack. Improper handling can result in death or serious injury.

There are two types of batteries powering your vehicle: a high-voltage lithium ion battery pack that powers the vehicle's electric powertrain motors and two 12V AGM batteries that power systems such as the infotainment displays and safety systems.

*Environmental:* Please recycle in accordance with local regulations.

## High Voltage Battery Pack Care

### Storage temperature

- **CAUTION:** Avoid exposing your vehicle to ambient temperatures above 113°F (45°C) or below -4°F (-20°C) for more than 24 hours at a time. Prolonged exposure can greatly reduce battery pack life and performance. If it is necessary to exceed these guidelines, whenever possible plug the vehicle in to a charging source to provide reliable thermal conditioning of the battery pack.

Extreme temperatures can damage the battery pack. If possible, avoid parking in direct sunlight, especially on hot, sunny days. Lucid also recommends that you keep your vehicle sheltered or parked in a garage whenever possible in extremely cold weather.

### Preserving high voltage battery pack health

The most effective way to prolong the battery (when not driving) is to leave it plugged into a charging source. Setting the charge level to "Daily" usage helps preserve battery health.

- **CAUTION:** When the vehicle is not in use for long periods of time, it's necessary to plug into a charging source and set the charge target to the minimum "Daily" value.

When your vehicle is left idle and unplugged, the battery pack gradually discharges over time. Allowing the battery pack to completely discharge to 0 mi (0 km) could cause permanent damage. Battery pack life and performance are greatly improved by maintaining a healthy state of charge (generally between 40% and 80%).



When the remaining battery pack charge falls below the 50 mi/80 km range, the Cockpit Panel shows a yellow low battery indicator.

When the battery pack charge level falls below 10 mi (16 km), warnings display on the Cockpit Panel. Proceed to the nearest charging station as soon as possible in order to avoid a vehicle shutdown.

When poor battery pack health is detected, the Cockpit Panel displays a warning indicator.

As is normal with all lithium-ion batteries, battery pack performance degrades over time. When the battery pack needs service, the Pilot Panel displays a warning and you should contact Lucid Customer Care to schedule service.



# Charging Instructions

## Safety Checklist

- **WARNING:** If you have any concerns with the condition of a wall outlet, the charge port or the charging cable, DO NOT use them. Seek assistance from a qualified electrician or a Lucid Service Center. Using charging equipment that is damaged or faulty may result in injury, death, or property damage.

Before charging your vehicle, check the following items:

- If using a domestic wall outlet, inspect the outlet and do not use it if it appears damaged or worn.
- Inspect the charging cable and connector for damage, including frays or cracks. If a part appears damaged, do not use it.

*Note:* If the Lucid Mobile Charging Cable is damaged, contact a **Lucid Service Center**.

- Ensure that the charging cable is fully uncoiled before use.
- Check that the charging connector and charge port are clean and unobstructed. If you find any contamination or a foreign object in either part, do not use them and contact a **Lucid Service Center**.
- Check that the charging cable and charge port are dry. Ensure that your hands are dry, and there is no water or other fluids in the surrounding area (such as puddles on the ground).





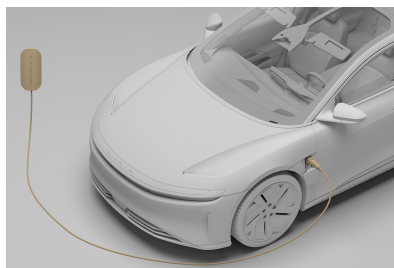

## Charge Port Door

The charge port door is located to the rear of the left front wheel.



## Opening and closing the door

Car doors must be unlocked for the charge port to open. You can open and close the charge port door using any of the following methods:

- On the left Cockpit Panel, press the  charge port icon.
- On the Pilot Panel, select  >  DOORS and press the  charge port icon.
- On the Pilot Panel, select  >  ENERGY and press the OPEN CHARGE PORT button.
- Use the Lucid mobile app.
- With a valid key fob detected within 6.5 feet (2 m) of the unlocked vehicle, press the bottom of the charge port door and it will open automatically. The charge port door automatically closes after unplugging the charging cable; otherwise, you can gently push upward on the bottom of the door until automatic closing takes over.

Charging the Vehicle

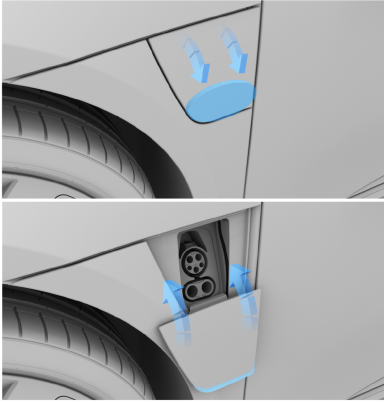

- **CAUTION:** If the charge port door has iced over in cold weather conditions, DO NOT attempt to break the ice using blunt force (that is, hitting or chipping at it with a tool), as this could cause damage.

*Note:* If the charge port door has iced over, Lucid recommends using the in-vehicle controls or the Lucid mobile app to cycle the open/close function of the door until the ice breaks.

**Manually opening the door**

- **CAUTION:** Manually opening the charge port door is only recommended in instances where the vehicle has no power and the 12V batteries cannot be charged.

If the vehicle has no power, the charge port door can be opened manually:

1. Open the driver's door.
2. Place your finger at the bottom right corner of the charge port door and gently lift up.
3. Continue lifting on the corner until a gap begins to form between the top edge and the fender.
4. Once there is a gap along the top edge, insert your fingers into the gap and gently pull downward until a hard stop is reached.

Your vehicle is supplied with a Lucid Mobile Charging Cable kit, which is stored in the trunk. For instructions and additional details about this charger, please see the [Lucid Mobile Charging Guide](#).

To begin charging (using the Lucid Mobile Charging Cable), plug the J1772 (type 1) connector into the car's charge port.

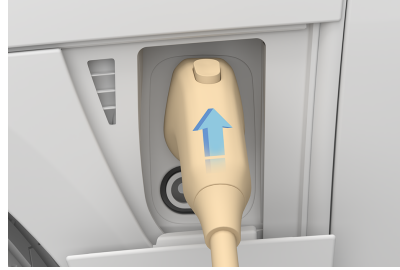

*Note:* During charging, the battery system's heating and cooling functions monitor the temperature of the battery pack, and will turn on or off as needed to help maintain an ideal temperature. Clicking or fan noises are normal.

**Errors during charging**

If an error occurs, the charge port light turns red. If this happens, details and instructions will be displayed on both the Pilot Panel and the Cockpit Panel.

If following the steps in the displayed instructions does not resolve the error, contact Lucid Customer Care for further assistance.

**Stopping charging**

To stop charging before the process is completed, press the STOP CHARGING button on the ⚡ ENERGY screen of the Pilot Panel. You can also stop charging using the Lucid mobile app.

Disconnecting the Charging Cable

To stop a charging session, press the button and then pull the charging cable toward you to disconnect from the charge port.

**Note:** The vehicle cannot be driven when the charging cable is connected to the charge port. If you attempt to shift out of P (Park), a notification appears on the Cockpit Panel.

### Emergency manual charging cable disconnect

- **CAUTION:** Manually releasing the charging cable is only recommended in instances where the charging cable button will not release it from the charge port.

If pressing the button on the charging cable will not release it, the vehicle has a manual disconnect:

1. Open the hood. See [Hood Opening and Closing](#).
2. Pull up on the manual disconnect lever to release the charging cable.

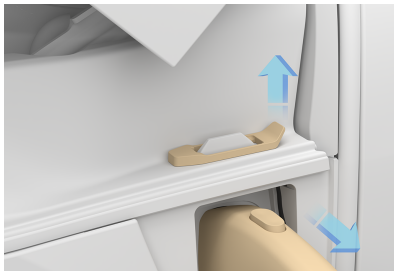

3. Make sure to correctly insert the manual disconnect lever to its original position before closing the hood.

#### Charging Status

You can check the progress of the charging process via the light on the charge port, the in-vehicle displays, or the Lucid mobile app.

### Charge port light

The charge port light indicates the current charging status. Refer to the following table to understand the meaning of each light color and pattern.

Color	Definition
White (Solid)	Ready to charge
White (Flashing)	Charging pending

Color	Definition
Green (Flashing)	Charging in progress
Green (Solid)	Charging completed
Red (Solid)	Charging error

During charging, the progress meter of the charge port light flashes green, indicating the current charge level of the battery pack.

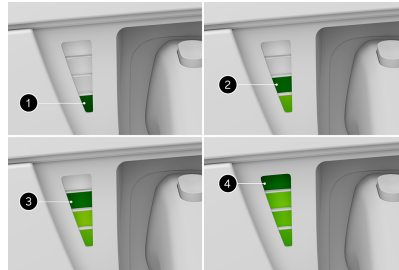

1. 0% - 24%
2. 25% - 49%
3. 50% - 74%
4. 75% - 99%

When charging is completed, the light will remain solid green.

### Vehicle display status

Once charging begins, the Pilot Panel and the Cockpit Panel will both display the current charging status, including time remaining to completion.

#### Cockpit Panel charging display



#### Setting a Charge Limit

- **CAUTION:** Charging beyond the recommended level too often can cause battery pack degradation.

Without a set charge limit, the charging system will charge the battery to the recommended level. The vehicle dynamically adjusts the actual charging rate depending on the state of charge, ambient temperature, battery pack temperature, and position of the charge slider.



You may need to adjust the charge limit higher or lower according to your driving needs. A higher charge limit will increase trip distance. Vehicles that are parked for extended periods should be plugged in and use a lower charge limit to maintain battery pack health.

Follow these guidelines for setting the charge limit:

- For the fastest possible charge rate (miles/minute), set the slider as low as practically possible for the intended use of the vehicle.
- For general use, set the slider to "Daily" or 50% - 80%. This setting best preserves the battery pack life.
- For more range, set the slider beyond "Daily" and up to "Distance." "Distance" allows a full charge.

When charging beyond the "Daily" setting, you may notice changes in reduced regenerative braking and charging speeds. This functionality gradually returns as the car is driven.

To set the charge limit:

1. On the Pilot Panel, select  >  ENERGY to display charging options.
2. Press the SET CHARGE LIMIT button.
3. Use the slider to set the desired level of charge between 50% - 100%. Set the slider to Daily for general use and Distance for a long-range trip.
4. Press the DONE button.

Cold Weather Charging Considerations

- **CAUTION:** Do not expose your vehicle to extreme temperatures for long periods without driving or connecting to a charging cable, as this can

negatively affect battery pack life. When temperatures are below 41°F (5°C) and you are not driving your car, connect to a charging cable.

In very cold weather you may experience a range reduction. The Pilot Panel will automatically switch to the  ENERGY screen, displaying the reduction and remaining range.



When the battery pack is too cold and needs to reserve energy, a blue battery warning indicator will be displayed on the Cockpit Panel.

09

# Maintenance

# Maintenance Requirements

## Your Responsibility

---

The safety, reliability, and performance of your vehicle depends partly on how well it is maintained. Maintenance is an owner's responsibility, and you must ensure appropriate vehicle upkeep according to Lucid's recommendations.

## Scheduled Maintenance

---

Your vehicle will display a message on the Cockpit Panel when the annual scheduled maintenance is due.

**Lucid** recommends entrusting a **Lucid Service Center** to perform the majority of the regular servicing and maintenance of your vehicle. **Lucid** Service Centers have the specialized knowledge and equipment necessary to ensure the best possible service and care for your vehicle.

## Fluid Replacement

---

**Lucid Service Centers** will replace the necessary fluids in your vehicle during regularly scheduled service intervals.

## Owner Maintenance

---

- **WARNING:** Some fluids used in electric vehicles are poisonous and should not be consumed or brought into contact with open wounds. These fluids include brake fluid, battery acid, battery coolant, and windshield washer additives. Always read and obey all instructions printed on fluid container labels.
- **WARNING:** Any significant or sudden drop in fluid levels or uneven tire wear should be rectified immediately.

In addition to scheduled maintenance performed by **Lucid**, you must carry out a few simple checks more frequently. Details are provided in the remainder of this section.

## Daily checks

- Look for fluid deposits underneath the vehicle that might indicate a leak.  
*Note:* A small puddle of water may collect under the vehicle if the air conditioning has been running, which is normal.
- Check the charge level of the battery displayed on the Cockpit Panel. See [Battery State of Charge Indicator](#) on page 64.
- Check the operation of the seat belts, horn, wiper and washer, turn signals, and all exterior lights.
- Check the operation of the brakes and ensure that the parking brake automatically engages when the vehicle is in P (Park).

## Monthly checks

- Check the windshield washer fluid level and top off if needed. See [Checking Windshield Washer Fluid](#) on page 158.
- Turn on the air conditioning to ensure that it is working properly. See [Temperature Control](#) on page 84.
- Check the pressure, wear, and condition of each tire. Check the vehicle mileage to determine whether the tires are due to be rotated. See [Maintaining Tire Pressures](#) on page 177.
- **WARNING:** If you discover abnormalities during these checks, such as uneven tire wear or a sudden drop in fluid levels, contact Lucid immediately.

- **WARNING:** Always disconnect the charging cable before working underneath the vehicle or the hood, regardless of whether or not it is charging. See [Disconnecting the Charging Cable](#) on page 149.
- **WARNING:** Some cooling fans operate even when the vehicle is powered off. Keep hands, hair, clothing, and tools clear of the fan blades at all times.

While your vehicle was built with the safety of you and your occupants as first priority, it is important to be aware of the risk of injury associated with high-voltage systems and protect yourself accordingly.

- Read and follow the directions on all safety labels attached to the vehicle.
- There are no user-serviceable parts in your high-voltage system. Do not attempt to access the high-voltage system or disassemble, remove, or replace any system components. All high-voltage cables are colored orange for easy identification.
- In the event a high-voltage cable or component becomes damaged, never touch any high-voltage cables, connectors, or components connected to the cables. There is a risk of fatal injury by burning and electrocution if the system's high voltage is still active.
- In the event of a collision, never touch any high-voltage wiring, connectors, or components connected to the wiring, even if you think the vehicle may not be powered on. There is a risk of fatal injury by electrocution if the system's high voltage is still active.
- Should a vehicle fire occur, immediately evacuate the vehicle and contact your local fire emergency responders, as they possess the proper training and equipment to safely extinguish fires in electric vehicles.

Maintenance Schedule

The scheduled maintenance or service must be performed in accordance with the chart below to keep your vehicle in top operating condition.

The service intervals in this maintenance and service schedule are based on average driving conditions. Some items will need more frequent service if you drive in unique conditions, such as unusually wet or dusty areas. For recommendations applicable to your individual needs and usage, consult your **Lucid Service Center**.

*Note:* Bring your charging cable and all key fobs with you to every service appointment to be checked during the multi-point inspection.

Maintenance Items	Every 1 year or 12,000 miles (19,310 km)	Every 2 years or 24,000 miles (38620 km)	Other
Multi-point inspection	•		
Tire rotation and tire balance (19-inch wheels only)	•		
Cabin air filter replacement	•		More often under unique conditions
Brake fluid replacement		•	More often under unique conditions
Key fob battery replacement	•		
Sun visor battery replacement	•		
Wiper blade replacement	•		
Air conditioning performance check		•	
Battery health check		•	
12V Battery replacement			Every 4 years or 48,000 miles (xx000 km)
Tire repair sealant replacement			Every 5 years or 60,000 miles (96560 km)
Coolant check			Every 5 years or 56,000 miles (58000 km)



Your vehicle should be given a full multi-point inspection service every 12 months or 12,000 miles (19300 km), whichever comes first.

*Note:* A message displays on the Cockpit Panel to remind you to service your vehicle.

This service includes inspections and checks for the following systems:

- Steering alignment
- Battery (12V) condition
- Battery pack (HV) condition
- Coolant condition
- Brake fluid condition
- Brake rotors and pads wear
- Chassis bolts torque
- Closures (doors, hood, and trunk) operation
- Condenser (check for debris)
- Electronic parking brake operation
- Heating, ventilation, and air conditioning operation
- Horn
- Interior and exterior lights
- Key fob operation
- Seat belts operation
- Tire pressure and tire wear
- Visual signs of fluid leaks
- Wipers and washers
- Charging system and charging cable
- Firmware

Your vehicle will also be given a road test to inspect its current driving condition (such as pedal operation, vehicle handling, and

steering alignment) and to check for any abnormal operational noises.

- **WARNING:** Your vehicle is equipped with two 12V batteries. It's critical that the 12V batteries are replaced **ONLY** with identical parts or parts approved by Lucid. Failure to do so could put safety of the vehicle and occupants at risk.
- **CAUTION:** Due to the location of the batteries, Lucid recommends that replacement of these batteries is only carried out by a Lucid Service Center.

# Fluid Reservoirs

## Checking Brake Fluid

### Low brake fluid warning indicator

If the fluid in the brake reservoir drops below the recommended level, the brake warning icon will be displayed on the Cockpit Panel. This will be accompanied by a notification message.

- **WARNING:** If the low brake fluid notification displays while driving, stop as soon as safety permits by gently applying the brakes. Do not continue driving. Contact a Lucid Service Center immediately.

### Checking the fluid level

Check the brake fluid level with the vehicle on level ground.

1. Remove the under hood rear apron.
2. Remove the brake reservoir cover.

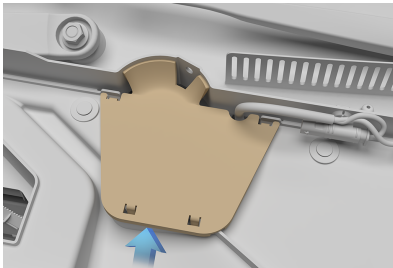

3. Check the fluid level visually by looking at the outside marks on the side of the reservoir without removing the filler cap.

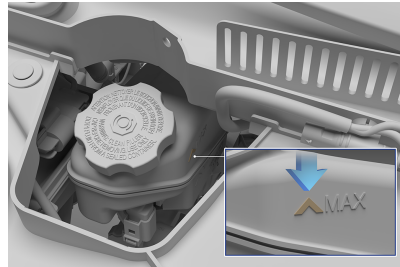

The brake fluid level should always be between the MIN and the MAX marks.

*Note:* Although brake fluid level drops slightly during normal use as a result of brake pad wear, it should not drop below the MIN mark. Excessive or frequent fluid loss may indicate a leak in the system.

### Topping off brake fluid

- **WARNING:** Only use new fluid from a sealed, air-tight container. Never use previously used fluid or fluid from a previously opened container. Excess moisture in the brake fluid can cause a dangerous loss of braking efficiency.
- **WARNING:** Brake fluid is highly toxic. Keep containers sealed and out of the reach of children. If accidental consumption of brake fluid is suspected, seek immediate medical attention.
- **WARNING:** Do not allow brake fluid to come into contact with your eyes. If this happens, flush your eyes with clean water for at least 15 minutes and seek immediate medical attention.

To top off the fluid:

1. Clean the filler cap before removing to prevent dirt from entering the reservoir.
2. Unscrew the cap and remove.
3. Fill the reservoir to between the MIN and the MAX marks using a clean funnel

and brake fluid meeting specification DOT4.

4. Install the reservoir cap.

- **CAUTION:** Brake fluid will damage painted surfaces. Immediately soak up any spills with an absorbent cloth and wash the affected area with a mixture of car shampoo and water.

### Replacing brake fluid

The brake fluid should be replaced every 2 years or every 24,000 miles, whichever comes sooner.

#### Checking Windshield Washer Fluid

Check the level of the windshield washer fluid monthly, or more frequently if you use it often.



If the quantity of fluid remaining in the washer reservoir drops below the recommended level, an indicator displays on the Cockpit Panel.

This will be accompanied by a notification message.

Operate the washers periodically to check that the nozzles are clear and properly directed. If a washer jet performs poorly, see [Cleaning Washer Jets](#).

### Topping off windshield washer fluid

- **WARNING:** In temperatures below 4°C (39°F), use a washer fluid with deicer. In cold weather, using a washer fluid without deicer can cause the fluid to freeze on contact with the windshield, impairing visibility.

*Note:* Some national or local regulations restrict the use of Volatile Organic Compounds (VOCs). VOCs are commonly used as antifreeze in washer fluid. Use a washer fluid with limited VOC content only if it provides adequate freeze resistance for all climates in which you drive.

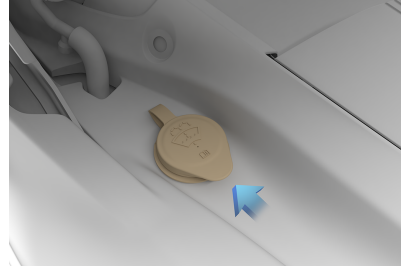

1. Clean the filler cap before opening to prevent dirt from entering the reservoir.
2. Open the filler cap.
3. Fill the reservoir until the fluid is visible just below the filler neck.
4. Close the filler cap.

- **CAUTION:** Washer fluid can damage painted surfaces. Wipe up any spills immediately with an absorbent cloth and wash the affected area with water.

# Wiper Blades and Washer Jets

## Checking the Wiper Blades

- **CAUTION:** Only use cleaning products that have been approved for use on automotive glass and rubber. Inappropriate products may cause damage, smearing, or increased glare on the screen.

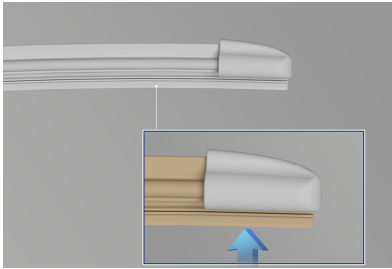

You should periodically check and clean the wiping edge of the wiper blade. Clean the blade edge using a soft cloth or sponge, and isopropyl (rubbing) alcohol or windshield washer fluid. Also, check the blade rubber for cracks, splits, or roughness. If any damage is found, replace the blade immediately to prevent damage to the glass.

## Replacing Wiper Blades

**Note:** For optimum performance, replace the wiper blades at least every year.

Life expectancy of wiper blades can vary, depending on geographical area and frequency of use. Poor wiper blade performance can result in "chattering" (that is, skipping across the glass), or leaving behind marks, streaks of water, or wet spots. If any of these conditions are present, clean the wiper blades or replace them as needed.

## Replacing the front wiper blades

- **CAUTION:** Only install wiper blades that are the same length and identical to the original specification. Failure to do so may cause poor performance and damage to the wiper system.

1. Open the hood. See [Hood Opening and Closing](#).
2. Lift the wiper arm away from the windshield.
3. Depress the locking tab while sliding the wiper blade away from the arm and remove.

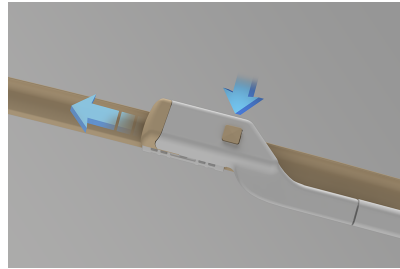

4. Installation of the new wiper blade is the reverse of removal. You should be able to hear and feel it click into place on the wiper arm.
5. Gently lower wiper blade back on to the windshield.

## Cleaning Washer Jets

- **WARNING:** Do not operate the washer jets during cleaning. Windshield washer fluid may cause irritation to the eyes and skin. Always read and observe the washer fluid manufacturer's instructions.

Because the washer jets are located on the wiper arms, it is easier to clean them by opening the hood first. See [Hood Opening and Closing](#).

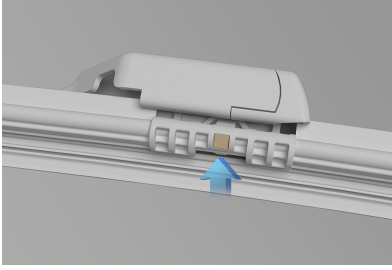

If a washer jet nozzle becomes clogged with debris or build-up, its performance can be reduced. There are several methods for removing any blockage:

- Dip a small, soft-bristled brush (such as an old toothbrush) in warm water and scrub in and around the nozzle to clear away any dirt or debris.
- Use a can of compressed air to blow a concentrated stream of air into the clog to loosen it, and to blow away any debris from the nozzle.
- For more serious clogs, slide a thin piece of wire into the nozzle to clear any blockages.

---

# Cabin Air Filter

---

## Replacing the Cabin Air Filters

---

Your vehicle has two cabin air filters installed that prevents pollen, industrial fall-out, road dust, and other particles from entering the vehicle via the vents.

The cabin air filters should be replaced every year or every 12,000 miles (19,310 km), whichever comes sooner. Failure to replace the air filters will result in reduced air flow into the vehicle.

*Note:* To gain the maximum benefit of the cabin air filters, it is suggested the filters are changed prior to the pollen season.

*Note:* If you operate your vehicle in an environment where there is more dust or sand in the air, the air filters may require replacement more frequently.

---

# Vehicle Care

## Cleaning the Exterior

---

- **WARNING:** Never charge your vehicle while washing it. Unplug the charging cable and close the charge port cover. Liquids entering the charge port while the cable is plugged in could result in serious personal injury, as well as damage to the vehicle, charging equipment, or property.
- **WARNING:** After washing the vehicle, wet brakes can result in longer stopping distances. To dry the brakes, drive the vehicle slowly while gently pressing the brake pedal a few times to warm up the brakes.

Your vehicle should be washed regularly to preserve the finish and maintain its overall appearance.

To protect the paint surfaces, wash your vehicle as soon as possible:

- When mud, dust, soot, or dirt builds up on the surface
- After driving on coastal roads or winter roads treated with salt
- When corrosive contaminants such as tree sap, bird droppings, or bugs collect on the surface
- After a rainfall to prevent possible damage from acid rain

*Environmental:* It is illegal to pollute drains, rivers, and waterways. Some cleaning products contain chemicals that are hazardous to the environment. Used toxic chemicals must be disposed of at authorized waste disposal sites only. Always take precautions to prevent fluids from spilling.

### Hand washing

- **CAUTION:** Avoid using rough or tightly-napped cloths (such as washing mitts) on the vehicle, as these can be abrasive enough to damage the finish.

- **CAUTION:** Avoid washing your vehicle in direct sunlight. Water and cleansers dry faster on a hot surface and can leave water spots or stains.

When washing your vehicle by hand, follow these steps:

- Rinse the entire vehicle first to remove as much excess dirt and dust as possible and reduce the risk of scratches from washing.
- Wash using a clean, soft cloth or sponge and cold or lukewarm water mixed with a mild car soap.
- Rinse your cleaning tools often to avoid rubbing debris into the finish, especially if your vehicle is exceptionally dirty.
- Do not aim water hoses directly at window, door, or hood seals, or through wheel apertures onto brake components.
- After washing, rinse the vehicle thoroughly with clean, cool water until all the soap has been removed.
- To avoid leaving water spots on the finish, dry the vehicle thoroughly with a chamois or cotton cloth.

### Removing tar spots

- **CAUTION:** Do not use acidic, abrasive, or petroleum-based cleansers, as these can damage the vehicle's paint and the plastic or metal parts.

You can use denatured alcohol to remove tar spots and stubborn grease stains from paint.

After cleaning, immediately wash the area with soapy water to remove the alcohol.

**Automatic car washes**

- **CAUTION:** Do not use a car wash that applies cleansers containing acid. Acid can react with the plastic in some vehicle components and damage them. Always check with your car wash to confirm that acid is not used.
- **CAUTION:** Leave the windshield wipers in the off position while in a car wash to avoid damaging them.

**Lucid** recommends using only touch-free automated car washes that do not bring brushes or other cleaning tools in direct contact with the vehicle body.

*Note:* Vehicle or paint damage caused by using an automatic car wash will not be covered under the vehicle warranty.

**Pressure washers**

- **CAUTION:** Do not use a pressure washer with a circular jet or bristle attachment, as it could damage the surface finish of components.
- **CAUTION:** Pressure washers that have a pressure exceeding 1,200 PSI (82 bar) can damage or even remove vehicle paint if used improperly.
- **CAUTION:** Do not use a hot or steam pressure washer with a temperature exceeding 120°F (48°C), as this could remove paint and surface protection from exterior parts.

Keep the nozzle at least 12 inches (30 cm) from the surface of the vehicle. Always keep the nozzle moving and do not concentrate the spray on a single area.

Do not aim the pressure washer at any of the following:

- Door and window seals
- Roof seals
- Ventilation intakes
- Plastic trim components
- Electrical components

- Exterior cameras or sensors (see [ADAS Component Locations](#))
- Tires and brake system components

*Note:* Vehicle or paint damage caused by using a pressure washer will not be covered under the vehicle warranty.

**Underbody maintenance**

If salt has been used on the roadways (such as during winter months), thoroughly remove all traces of road salt. Use a hose to rinse salt from the underside of the vehicle.

Flush away accumulations of mud in areas where debris easily collects (such as wheel arches and panel seams).

**Wheels**

- **CAUTION:** Do not use chemical-based wheel cleaners, as these can damage the finish of the wheel.

Wash the wheels with warm, fresh water containing a good quality wash and wax shampoo. Thoroughly rinse the wheels to remove any soap residue.

**Windshield, windows, and mirrors**

- **CAUTION:** Mirror glass is particularly susceptible to damage. Do not use abrasive cleaning compounds.

You should regularly clean all windows inside and out using a window cleaning solution. An automotive glass cleaner is recommended.

After washing your vehicle with washing or waxing products, clean the outside of the windshield with glass cleaner.

**Wiper blades**

You should clean wiper blades using isopropyl (rubbing) alcohol or windshield washer fluid. Do not use petroleum-based cleaners.

Polishing, Paint, and Body Repairs

- **CAUTION:** Always wash your vehicle before waxing or polishing.
- **CAUTION:** Do not polish or wax your vehicle in direct sunlight.



- **CAUTION:** Do not use wax or polish containing any harsh abrasives, cutting compounds, or cleansers that may damage the vehicle finish. If in doubt when choosing a product, please contact Lucid for recommendations.
- **CAUTION:** Carefully read and follow all of the instructions provided by the manufacturer of the wax or polish product.

Regular waxing helps to protect the paint surfaces from harsh elements and maintain their appearance. After the first year, **Lucid** recommends polishing your vehicle before reapplying wax. Polishing removes built-up residue and keeps the surface of the finish even.

The exterior paint should be regularly checked for damage. Any minor scratches or chips should be repaired as soon as possible using touch-up paint (contact Lucid for recommendations).

Body repairs should only be performed by a body shop approved by **Lucid**. Contact a **Lucid Service Center** for assistance in locating an approved body shop near you.

#### Using a Car Cover

- **CAUTION:** Never use a car cover when the vehicle is plugged in, as this can prevent the battery from being adequately cooled during charging.

To preserve the cosmetic appearance of the body when the vehicle is not being used, you may wish to use a car cover.

#### Cleaning the Interior

##### General cleaning

- **WARNING:** Exposure to chemicals in some cleaners can be hazardous and can irritate eyes and skin. Always read and follow the manufacturer's instructions when using cleaning products.
- **WARNING:** Do not splash or spill liquids in the vehicle, as this could cause an electrical component to

malfunction or catch fire. Any spills should be immediately wiped up using a clean, dry cloth.

- **CAUTION:** Do not apply cleaning products directly to the surface being cleaned. Instead, apply non-solvent based cleaning products to a soft cloth and then apply to the surface being cleaned. Cleaning products entering into components may cause damage or impair their function.
- **CAUTION:** Avoid using solvents (including alcohol), bleach, citrus, naphtha, or silicone-based products or additives on interior components, as these can damage the appearance of the material.

To maintain the look and appearance of the interior of your vehicle, you should inspect and clean the interior frequently.

For general cleaning, it is recommended that materials and surfaces should be cleaned using a non-solvent based cleaning (wet) wipe, and dried with a microfiber cloth.

If possible, try to wipe up spillages and clean marks as soon as they happen. This will reduce the need for more extensive cleaning in the future.

*Note:* It is advisable that you test all cleaners on a concealed area before use.

##### Interior glass and mirrors

- **CAUTION:** Do not scrape surfaces or use abrasive cleansers or cloths, as this could cause damage to some surfaces (such as the heating elements).



Use an alcohol-based commercial glass cleaner and a soft cloth (such as microfiber) to clean any glass or mirrored surfaces.

##### Displays

- **WARNING:** Do not use polish or wax cleaners on the display screens. Polished surfaces are reflective and may interfere with the driver's view, resulting in an accident.

- **CAUTION:** Do not use statically-charged materials (such as a cloth that was recently machine-washed and dried) on the displays.
- **CAUTION:** Do not use cleansers (such as glass cleaner) to clean displays.

Display screens should only be cleaned using a soft, lint-free cloth designed for cleaning screens and monitors.

Before cleaning the display screens, use the Pilot Panel to enable screen cleaning mode to prevent accidental operation of vehicle controls. Select  >  Displays > Displays & Accessibility > SCREEN CLEANING MODE.

### Airbags

- **WARNING:** Airbag covers should only be cleaned using a slightly dampened cloth or cleaning wipe. Water or any other liquid entering into an airbag or its associated electrical wiring may cause the airbags to deploy or not function properly in an accident.
- **WARNING:** Any damage or cracks on an airbag cover should be referred to a Lucid Service Center for inspection.

### Seats

- **WARNING:** Never use steam or upholstery cleaners on the seats, or any cleaning method that would saturate the seat with liquid. This can damage the occupancy weight sensor in the seat, which in turn can affect the operation of the airbag system and result in serious injury or death.

For cloth seats:

- If necessary, gently vacuum the seats first to remove any loose dust, dirt, or debris.
- Use a soft, colorless cloth moistened with warm water and (if necessary) non-detergent soap. Wipe gently in a circular motion. Allow the seats to air dry after cleaning.

For leather and artificial leather seats:

- To clean, use a soft, colorless cloth moistened only with warm water. Do not use polishes, oils, cleaning fluids, solvents, or detergents.
- Avoid vacuuming. Instead, use your moistened cleaning cloth to gently remove any loose particles.
- Application of a leather conditioner is not necessary to maintain the original condition of the seats.

### Seat belts

- **WARNING:** Never allow any substance to enter a seat belt mechanism, as this can negatively affect its performance in an impact.

Extend the seat belt and clean using a cloth moistened only with water. Do not use any type of detergent or chemical cleaning agent. Allow the belts to air dry while extended, away from direct sunlight if possible.

### Chrome and metal surfaces

Do not use abrasive cleansers, rough cloths, or polish, as these materials can damage the finish of these surfaces.

### Plastic materials

- **WARNING:** Do not use polish or wax cleaner on the upper surfaces of the dashboard. Polished surfaces are reflective and may interfere with the driver's view, resulting in an accident.

You should clean heavily-soiled plastic surfaces using warm water and a non-detergent soap, then wipe clean with a soft cloth.

### Carpets and floor mats

Vacuum the carpets and mats thoroughly before cleaning to remove excess dirt and debris.

Avoid over-wetting the carpets. A diluted upholstery cleaner can be used on heavily soiled areas.

Remove floor mats before cleaning to ensure that they dry properly afterwards. Clean using a microfiber cloth and water or a mild textile

---

cleanser. Spot-test any cleansers first to ensure they will not leave stains. Dry the mat thoroughly before reinstalling.

#### Floor Mats

---

- **WARNING:** Loose or improperly fitted floor mats could interfere with the operation of the foot pedals, which could lead to loss of vehicle control and a collision.
- **WARNING:** Do not place additional floor mats over the existing ones.
- **WARNING:** Always install floor mats with the correct side facing up. Do not turn them over.

Using genuine **Lucid** floor mats can extend the life of your vehicle's carpet and make it easier to clean. Mats should be maintained with regular cleaning and replaced if they become worn or damaged.

Floor mats should be inspected periodically to ensure they are properly installed. Lightly pull on the mat to check that it is securely fastened. Depress each foot pedal fully and reinstall the mats if any interference is felt.

# Parts and Accessories

## Parts, Accessories, and Modifications

- **WARNING:** Lucid does not recommend installing non-approved parts and accessories or performing non-approved vehicle modifications. Doing so can negatively affect your vehicle's performance and the safety of its occupants. The warranty will not cover any damage caused by using or installing non-approved parts or accessories, or performing non-approved modifications.
- **WARNING:** Lucid is not responsible for death, injury, or damage that occurs as the result of using or installing non-approved parts or accessories, or making non-approved modifications.

Genuine **Lucid** parts and accessories are the best choice for your vehicle. Lucid has rigorously tested all of their parts to ensure they meet the highest quality, safety, and performance standards.

Genuine parts and accessories can be purchased and professionally installed at a **Lucid Service Center**, where qualified technicians can offer you the best advice on repairs, accessories, and modifications.

Because they cannot assess products from other manufacturers or distributors, **Lucid** is not responsible for any issues related to using non-**Lucid** parts or accessories on your vehicle.

*Note:* If you have a disability which may require modification to the vehicle, please contact **Lucid** before any modifications are made. See [Contacting Lucid Motors](#) on page 211.

## Body Repairs

If your vehicle is damaged due to a collision, please contact a **Lucid Service Center** for referral to an approved body repair shop. This will ensure repairs are performed by a qualified technician using proper equipment and genuine **Lucid** parts. Poorly performed collision repairs can compromise

the performance and safety of the vehicle, and the resale value can be diminished.

Some repair shops may suggest using other parts instead of those made by **Lucid**, including salvaged or refurbished parts, or aftermarket parts made by other companies. While these suggestions may cut repair costs, they are not recommended and are not covered by the warranty.

- Salvaged parts may maintain the vehicle's designed appearance, but their unknown history means they may have been damaged during the previous vehicle's life or while in storage.
- Refurbished or aftermarket parts have not undergone extensive testing by Lucid to assure their safety or reliability.

Any vehicle failure related to salvaged, refurbished, or aftermarket parts is not covered by the warranty.

# Vehicle Lifting Points

## Lifting the Vehicle

- **WARNING:** Never raise the vehicle when the charging cable is connected, even if charging is not in progress. Always disconnect the charging cable before raising the vehicle. See [Disconnecting the Charging Cable](#) on page 149.
- **WARNING:** Do not work on an incorrectly supported vehicle. Doing so can cause serious damage, bodily injury, or death.

The lifting points for the vehicle are located at the positions shown below.

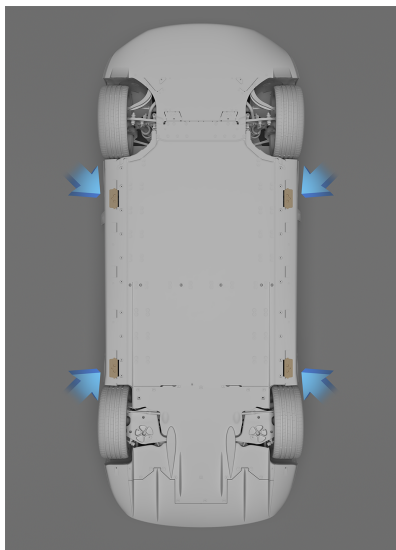

Ensure that any non-Lucid repair facility servicing your vehicle is aware of these lifting points when raising your vehicle on a lift.

- **CAUTION:** These are the only approved lifting points for your vehicle. Lifting the vehicle at any other points may cause irreparable damage to the vehicle.

## Steps for lifting the vehicle

1. Position the vehicle centrally between the lift posts.
2. Position the lift arm pads under the designated body lifting points at the locations shown.
  - **CAUTION:** DO NOT position the lift arm pads under the vehicle battery or side rails.
3. Adjust the height and position of the lift arm pads to ensure that they are correctly located.
4. With assistance, raise the lift to the desired height, ensuring the lift arm pads remain in their correct positions.
5. Engage any lift safety locks. Follow the lift manufacturer's instructions.

10

# Tire & Wheels



**4. Tire construction**

R indicates that the tire is of Radial ply construction. So, if a tire is marked P245/35R21, R is the Radial ply construction.

**5. Wheel diameter**

This two-digit number is the diameter of the wheel rim in inches. So, if a tire is marked P245/35R21, the wheel diameter is 21 inches.

**6. Load index**

This two- or three-digit number is the tire's load index. It is a measurement of how much weight each tire can support. This number is not always shown.

**7. Speed rating**

The speed rating, when stated, denotes the maximum speed at which the tire should be used for extended periods. The ratings range from 99 mph (160 km/h) to 186 mph (300 km/h). These ratings are listed in the following table.

Rating	Speed (mph)	Speed (km/h)
Q	99	160
R	106	170
S	112	180
T	118	190
U	124	200
H	150	210
V	149	240
W	168	270
Y	186	300

**8. U.S DOT Tire Identification Number (TIN)**

Regulations require that the TIN begins with the letters "DOT" and is followed by two numbers or letters that indicate where it was manufactured. The last four numbers represent the week and year the tire was built. For example, the number 1706 means the 17th week of 2006. The other numbers are marketing codes used at the manufacturer's discretion. This information can be used to contact consumers if a tire defect requires a recall.

**9. Maximum permissible inflation pressure**

Maximum permissible inflation pressure means the maximum cold inflation pressure to which a tire may be inflated. It is okay for the tire pressure to exceed this value when it is warmed up, but it must be at or below this pressure when the tire is cold.

**10. Treadwear grade**

This number indicates the tire's wear rate. See [Uniform Tire Quality Grading](#).

**11. Traction grade**

This letter indicates a tire's ability to stop on wet pavement. See [Uniform Tire Quality Grading](#).



---

## **12. Temperature grade**

This letter indicates a tire's heat resistance grading. See [Uniform Tire Quality Grading](#).

## **13. Tire composition and materials**

The number of plies in both the tread area, and the sidewall area, indicates how many layers of rubber coated material make up the structure of the tire. Information is also provided on the type of materials used.

## **14. Maximum tire load**

This is the maximum load that can be carried by the tire.

## **15. International tire approval marks**

See [International Tire Approval Marks](#).

International Tire Approval Marks

Before any tires can be sold in most countries, tire manufacturers must test and certify that all applicable safety and performance standards are met. This can include, sidewall branding, durability, physical dimensions, high-speed endurance, road noise, and wet traction.

Many tires are sold globally, so tires may be branded with multiple approval codes from various countries.

**United States**



United States Department of Transportation (DOT)

See [8. U.S DOT tire identification number \(TIN\)](#).

**China**



China Compulsory Certification (CCC) Mark

China Compulsory Certification mark for products being exported to or sold in the Peoples Republic of China.

**Europe**



United Nations Economic Commission of Europe (U.N.E.C.E.)

The symbol identifying the United Nations Economic Commission for Europe (U.N.E.C.E., sometimes referred to as E.C.E.) is found on a tire's sidewall which certifies that the tire manufacturer meets all regulations, including the load index and speed symbol appearing in its service description.

The letter “E” or “e” and number code (in a circle or rectangle) identifies the country where the tire was originally registered, followed by two digits (the Regulation Series) where the tire was approved (such as “02” for E.C.E. Regulation 30 governing passenger tires) followed by digits representing the E.C.E. mark, type-approval numbers.

Tested tires meeting the “pass-by” noise and wet traction limits may have another E.C.E. branding followed by an “-s” and “w” (for sound and wet traction, respectively). One or two E.C.E. symbols may appear on the tire's sidewall.

Uniform Tire Quality Grading

The following information relates to the tire grading system developed by the National Highway Traffic Safety Administration (NHTSA), which will grade tires by tread wear, traction and temperature performance.

*Note:* Tires that have deep tread, and winter tires, are exempt from these marking requirements.

Quality grades, where applicable, can be found on the tire sidewall between the tread shoulder and maximum section width. For example:

TREADWEAR 180	TRACTION AA	TEMPERATURE A
------------------	----------------	------------------

In addition to the marking requirements, passenger car tires must conform to Federal Safety Requirements.

**Treadwear**

The treadwear grade is a comparative rating based on the wear rate of the tire when tested under controlled conditions on a specified government test course.

For example, a tire graded 150 would wear one and a half times as well on a government test course as a tire graded 100. The relative performance of tires depends on the actual conditions of their use, however, and may depart significantly from the norm due to variations in driving habits, service practices,

---

and differences in both road characteristics and climate.

### Traction

*Note:* The traction grade assigned to this tire is based on straight-ahead braking tests, and does not include acceleration, cornering, hydroplaning, or peak traction characteristics.

The traction grades, from highest to lowest, are: AA, A, B, and C. These grades represent a tire's ability to stop on a wet pavement as measured under controlled conditions on specified government test surfaces of asphalt and concrete. A tire marked C may have poor traction performance.

### Temperature

- **WARNING:** The temperature grade for this tire is established for a tire that is properly inflated and not overloaded. Excessive speed, under-inflation, or excessive loading, either separately or in combination, can cause heat build-up and possible tire failure.

The temperature grades are A (the highest), B, and C, representing the tire's resistance to the generation of heat and its ability to dissipate heat when tested under controlled conditions on a specified indoor laboratory test wheel.

Sustained high temperature can cause the material of the tire to degenerate and reduce tire life, and excessive temperature can lead to sudden tire failure.

The grade C corresponds to a level of performance that all passenger car tires must meet under the Federal Motor Safety Standard No. 109.

Grades B and A represent higher levels of performance on the laboratory test wheel than the minimum required by law.

#### Tire and Loading Information Label

---

Open the left front door to locate the tire information label on the driver's side center pillar.





The label contains the following information:

- The maximum vehicle capacity weight in kilograms (kg) and pounds (lb).
- Maximum number of occupant seating positions in the vehicle.
- The size of the tires originally fitted to the vehicle.
- The cold inflation pressures for the original specification of front and rear tires.

The stated tire pressures provide the optimum vehicle ride and handling characteristics for all normal operating conditions.

Note: Do not change this label, even if you use different tires in the future.

 <b>TIRE AND LOADING INFORMATION</b> <b>RENSEIGNEMENTS SUR LES PNEUS ET LE CHARGEMENT</b>			<b>SEATING CAPACITY /</b> <b>NOMBRE DE PLACES</b>
<small>THE COMBINED WEIGHT OF OCCUPANTS AND CARGO SHOULD NEVER EXCEED / LE POIDS TOTAL DES OCCUPANTS ET DU CHARGEMENT NE DOIT JAMAIS DÉPASSER: 400 kg / 882 lb</small>			<b>TOTAL: 6</b> <b>FRONT / AVANT: 2</b> <b>REAR / ARRIÈRE: 2</b>
<b>TIRE / PNEU</b>	<b>SIZE</b>	<b>COLD TIRE PRESSURE /</b> <b>PRESSION DES PNEUS À FROID</b>	<b>SEE OWNER MANUAL FOR</b> <b>ADDITIONAL INFORMATION.</b> <b>VOIR LE MANUEL DE</b> <b>L'USAGER POUR PLUS DE</b> <b>RENSEIGNEMENTS</b>
<b>FRONT / AVANT</b>	XXX/XXX	XXX kPa / XX psi	
<b>REAR / ARRIÈRE</b>	XXX/XXX	XXX kPa / XX psi	
<b>SPARE / DE SECOURS</b>	NONE	- kPa / - psi	

# Tire Care and Maintenance

## Inspecting and Maintaining Tires

- **WARNING:** The tires should be regularly checked for wear and to make sure that there are no cuts, bulges, or exposure of the ply/cord structure. Do not drive with tires that are worn, damaged, or inflated to the incorrect pressure. Driving under any of these conditions could lead to collision due to tire failure and/or loss of control and result in serious injury or death to the occupants or others.

Always consider tire conditions when driving, and regularly inspect the tread and sidewalls for any sign of distortion (bulges), cuts, or wear.

Good driving practice will improve the mileage you obtain from your tires and avoid unnecessary damage.

- Always ensure that the tire pressures are correctly adjusted.
- Always observe the posted speed limits and advisory speeds.
- Avoid pulling away quickly or hard acceleration.
- Avoid making fast turns or braking sharply.
- Avoid potholes and objects on the road.
- Do not run over curbs or hit the tire against the curb when parking.

- **CAUTION:** Avoid contaminating tires with vehicle fluids that can cause damage.

### Tire wear

- **WARNING:** The tire wear indicators show the minimum tread depth recommended by the tire manufacturer. Tires that have worn to this point will have reduced grip and poor water displacement characteristics.

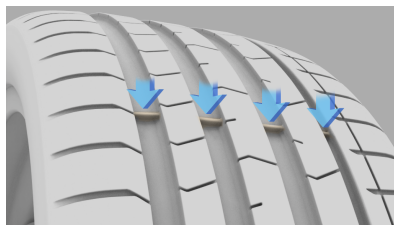

Tires fitted as original equipment have tread wear indicators molded into the tread pattern.

When the tread has been worn down to approximately 2/32 inch (1.6 mm), the indicators become flush with the surface of the tread pattern, producing the effect of a continuous band of rubber across the width of the tire.

A tire must be replaced as soon as an indicator band becomes flush to the tread, indicating the tread has reached the minimum permitted by legislation.

*Note:* Your **Lucid Service Center** will evaluate tire wear when servicing your vehicle.

### Wheel alignment and tire balance

Unbalanced wheels (sometimes noticeable as steering wheel vibration) may affect vehicle handling and tire life. Even with regular use, wheels can get out of balance. Therefore, you should balance your wheels as required.

*Note:* If tire wear is uneven (on one side of the tire only) or becomes abnormally excessive, you should check the wheel alignment.

### Wheel and tire rotation

- **WARNING:** Your vehicle may be fitted with different size tires on the front and rear wheels. The front and rear wheels may also have different offsets. Do not move wheels between the front and rear axles as this will severely affect vehicle handling.

**Lucid** does not recommend moving the wheels between the front and rear axles, or from side to side on the same axle pair.

**Punctured tires**

- **WARNING:** Do not drive the vehicle with a punctured tire. Even if the punctured tire has not deflated, it is unsafe to use as the tire may deflate suddenly at any time.

Your vehicle is fitted with tubeless tires, which may not leak when penetrated, provided the object remains in the tire.

If, however, you feel a sudden vibration or ride disturbance while driving, or you suspect your tire or vehicle has been damaged, immediately reduce your speed. Drive slowly while avoiding heavy braking or sharp steering, and when safe to do so, stop the vehicle.

Inspect the tires for damage. If a tire is under-inflated and does not appear to have any damage to the sidewall, try to repair using a tire repair kit. If you cannot detect the cause or the tire is too heavily damaged, have the vehicle recovered to a tire repair center, or a **Lucid Service Center** to have the vehicle inspected.

A puncture will eventually cause the tire to lose pressure, which is why frequent checking of tire pressures is important. Punctured or damaged tires must be permanently repaired or replaced as soon as possible.

**Age degradation**

Tires degrade over time due to the effects of ultraviolet light, extreme temperatures, high loads, and environmental conditions. It is recommended that tires are replaced every six years, but may require replacement more frequently.

Maintaining Tire Pressures

- **WARNING:** Use a gauge to check tire pressures when COLD. Under-inflation is the most common cause of tire failures and may result in severe tire cracking, tread separation, or "blowout," with an unexpected loss of vehicle control and increased risk of injury.

Each tire should be checked monthly and inflated to the pressure recommended on the vehicle placard or tire inflation pressure label. (If your vehicle has tires of a different size than the size indicated on the vehicle placard or tire inflation pressure label, you should determine the proper tire inflation pressure for those tires).

Driving on a significantly under-inflated tire causes the tire to overheat and can lead to tire failure. Under-inflation also reduces battery range and tire tread life, and may affect the vehicle's handling and stopping ability.





As an added safety feature, your vehicle has been equipped with a Tire Pressure Monitoring System (TPMS) that illuminates a low tire pressure indicator when one or more of your tires is significantly under-inflated. When the low tire pressure indicator illuminates, you should stop and check your tires as soon as possible, and inflate them to the proper pressure. See [Tire Pressure Monitoring System \(TPMS\)](#) on page 181.

- **WARNING:** TPMS is not a substitute for proper tire maintenance. As the driver, it is your responsibility to maintain correct tire pressure, even if under-inflation has not reached the level to trigger illumination of the TPMS low tire pressure indicator.

**Checking tire pressure**

- **CAUTION:** Perform pressure checks when the tires are COLD. A hot tire at or below recommended cold inflation pressure is dangerously under-inflated.
- **CAUTION:** If the vehicle has been parked in strong sunlight or used in high ambient temperatures, do not reduce the tire pressures. Move the vehicle into the shade and allow the tires to cool before checking.
- **WARNING:** Do not exceed the maximum pressure stated on the sidewall of the tire. Over-inflation could cause the tire to fail suddenly.

*Note:* The COLD Tire pressure is defined as the air pressure in a tire that has been standing in excess of three hours, or driven for less than one mile.

To view current tire pressures on the Pilot Panel. Select  >  Vehicle > Tire Pressure.

Note: Tire pressure is shown once the vehicle is driven over 13 mph (21 km/h).

If it is necessary to check the tires when they are warm, you should expect the pressures to have increased. Do not reduce the pressure of warm tires in an attempt to match the recommended cold tire pressures.

To view the recommended COLD tire pressures for your vehicle, select the RECOMMENDED tab. Always inflate your tires to the pressures recommended by **Lucid**, even if it is different from the maximum inflation pressure information found on the tire itself.

### Adjusting tire pressure

To check and adjust tire pressure:

1. Remove the cap from the valve, then firmly press the tire gauge onto the valve and measure the pressure.
2. If required, add air to reach the required pressure.
3. Check the pressure by removing the tire gauge and then re-attaching it. Failure to remove and re-attach the gauge to the valve could cause the gauge to show an incorrect reading.
4. If the tire pressure is too high, remove the gauge and release air from the tire by pressing on the metal stem in the center of the valve. Refit the gauge to the valve and check the pressure.
5. Repeat the process of adding or removing air as required until the correct tire pressure is reached.
6. Refit the valve cap.

### Tire valves

Keep the valve caps screwed down firmly to prevent water or dirt from entering the valve. Check the valves for leaks when checking the tire pressures.

### Flat spots

If the vehicle is stationary for a long period when the ambient temperature is high, the tires may form flat spots. When the vehicle is driven, these flat spots will cause a vibration that will steadily disappear as the tires warm up and regain their original shape.

### Tire pressures during long-term storage

Inflate tires to the maximum pressure as indicated on the tire wall to minimize flat spots during storage.

- **WARNING:** The tire pressures must be reduced to the correct pressure before the vehicle is driven.

### Tire pressures at high speeds

- **CAUTION:** Vehicle speed is capped depending on the trim level. Operating your vehicle at speeds over the speed limit is not recommended. Customer is responsible for obeying all traffic laws.

If operating the vehicle above 155mph (250 km/h), temporarily inflate the tire to a cold inflation pressure according to the table below. If the conditions in the table below are met, then all axle loads up to Front Gross Axle Weight Rating and Rear Gross Axle Weight Rating are acceptable.

Tire Size	Speeds below	Speeds above
	155mph (250 km/h)	155mph (250 km/h)
245/45R19	49 psi (540 kPa)	49 psi (540 kPa)
245/40R20	42 psi (290 kPa)	45 psi (310 kPa)
265/40R20	42 psi (290 kPa)	45 psi (310 kPa)
245/55R21	42 psi (290 kPa)	45 psi (310 kPa)
265/55R21	42 psi (290 kPa)	45 psi (310 kPa)

Note: Track or competition use of the vehicle is not covered under the Lucid New Vehicle Limited Warranty, and is not recommended.

- **WARNING:** For your safety, it is recommended that only wheels and tires that match the original specification are used on the vehicle. Specifications for approved winter tires are available by contacting your **Lucid Service Center**.
- **WARNING:** Operation of the Tire Pressure Monitoring System (TPMS) may be affected if the tires are replaced with a different specification from the originals.

Wheel rims and tires are matched to suit the handling characteristics of the vehicle. Always check that replacement tires comply with the original specification. If tires other than those specified are used, ensure that the load and speed ratings (shown on the tire side wall) equal or exceed those of the original specification.

Ideally, tires should be replaced as sets of four. If this is not possible, replace the tires in pairs (front and rear). When replacing tires, the wheels should be balanced and alignment checked.

### Asymmetric tires

- **WARNING:** Vehicle traction and handling will be seriously impaired if the tires are incorrectly installed on the wheels.

Your vehicle is equipped with Asymmetric tires that have different tread patterns on the outer and inner edge of the tire. On the outside edge, the tread pattern exhibits large tread blocks that are designed to provide dry traction and handling thanks to a larger contact area with the road.

On the inside edge, the tread block is smaller to provide better wet grip. An increased number of grooves helps disperse water on wet roads and reduce the risk of aquaplaning. This means the tire is built to provide great performance in both wet and dry conditions.

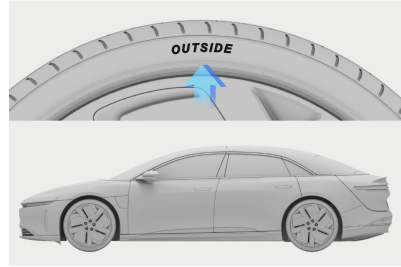

Asymmetric tires must be mounted on the wheel with the correct sidewall facing outwards from the vehicle. The sidewall of the tire is marked with the word **OUTSIDE**.

When new tires are installed, always make sure the tires are correctly oriented.

### Run-flat tires

- **CAUTION:** The installation of run-flat tires is not recommended by Lucid as they may cause issues with the sensors for the Tire Pressure Monitoring System (TPMS).

### Seasonal Tire Types

#### Summer tires

Your vehicle may be originally equipped with high-performance summer tires. Summer tires are designed for maximum dry and wet road performance but are not designed to perform well in winter conditions.

**Lucid** recommends using winter tires if driving in cold temperatures or on roads where snow or ice may be present.

- **WARNING:** Summer tires are not designed to provide adequate traction during cold temperatures, on snow, or ice. Selecting and installing the appropriate tires for winter conditions is important to ensure the safety and optimum performance of your vehicle.

#### All-season tires

Your vehicle may be originally equipped with all-season tires. These tires are designed to provide adequate traction in most conditions



---

year-round, but may not provide the same level of traction as winter tires in snowy or icy conditions. All-season tires can be identified by ALL SEASON and/or M+S (mud and snow) on the tire sidewall.

### Winter tires

- **WARNING:** Always follow the tire manufacturer's instructions. Pay special attention to the maximum speed you can drive your vehicle and the correct tire pressures.
- **WARNING:** The traction provided by winter tires on dry roads may be less than your original specification tires.

Use winter tires to increase traction when driving in sustained temperatures below 50°F (10°C), or in snowy or icy conditions.

For winter tires, always install a complete set of four tires at the same time. All winter tires should be the same diameter, brand, construction, and tread pattern on all four wheels.

For recommendations on winter tires, contact your **Lucid Service Center**.

#### Driving in Low Temperatures

---

Tire performance is reduced in low ambient temperatures, resulting in reduced grip and increased susceptibility to damage from impacts. Performance tires can temporarily harden when cold, causing you to hear rotational noise for the first few miles (kilometers) until the tires warm up.

#### Tire Traction Devices

---

### Tire chains

- **CAUTION:** The use of tire chains is not approved or recommended by **Lucid**. Using tire chains may damage your vehicle's suspension, body, wheels, and/or brake lines. Damage caused by using tire chains will not be covered by the New Vehicle Limited Warranty.

### Tire socks

In conditions where tire traction is challenging, tire socks may be fitted for

improvements in grip. Depending on the tire sock, permitted use cases may vary. Refer to the tire sock owner's manual for specific details on your product.

Snow socks are the recommended snow traction device, and recommended installation is on rear axle tires. Recommended wheel and tire configuration is the 19inch Aerorange wheels fitted with 245/45R19 Pirelli Pzero All-season tires (LM1, Lucid OE spec tires) or 245/45R19 Pirelli Sottozero Winter tires (LM1, Lucid OE spec tires).

*Note:* Winter tires usually offer more traction than tire socks.

*Note:* Although approved by **Lucid**, the use of tire socks may still be prohibited. Check [applicable](#) local laws before installing tire socks.

For recommendations on tire socks, contact your **Lucid Service Center**.

# Tire Pressure Monitoring System

## Tire Pressure Monitoring System (TPMS)

- **WARNING:** The TPMS is not a substitute for manually checking tire pressures. The TPMS only provides a tire pressure warning and does not re-inflate the tires.
- **WARNING:** The TPMS cannot register damage to a tire. Regularly check the condition of your tires.
- **WARNING:** Using liquid or aerosol tire sealants may cause a malfunction of tire pressure sensors.

The TPMS monitors the pressure of the tires using sensors located in each wheel. In-vehicle sensors receive TPMS data using Radio Frequency (RF) signals.

*Note:* Installing accessories that are not approved by **Lucid** may interfere with the TPMS system.



Tire pressure warnings are displayed on the Cockpit Panel using an amber warning indicator. A warning chime will sound, and a warning message will display to alert you to a problem.

The tire pressure warning indicator will illuminate if a tire is under-inflated.

If the tire pressure warning indicator illuminates, stop and check your tires as soon as possible and inflate them to the correct pressure. If the tire pressure warning occurs frequently, the cause must be determined and rectified.

### Tire pressure information display

If low tire pressure is detected, the Cockpit Panel will provide an overview of the tire pressures on the vehicle. The wheel with the low pressure will be displayed in amber.

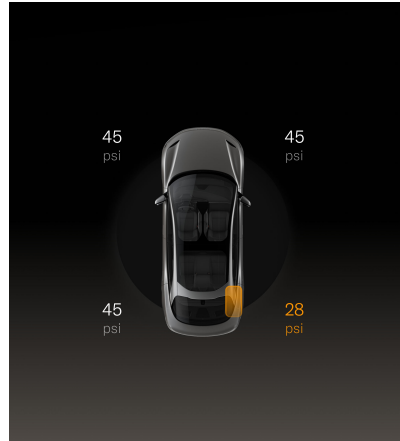

### TPMS malfunction

Your vehicle is equipped with a TPMS malfunction indicator to indicate when the system is not operating properly.

The TPMS malfunction indicator is combined with the low tire pressure indicator. When the system detects a malfunction, the indicator will flash for approximately one minute and then remain continuously illuminated. This sequence will continue upon subsequent vehicle start-ups as long as the malfunction exists.

When the malfunction indicator is illuminated, the system may not be able to detect or signal low tire pressure as intended. TPMS malfunctions may occur for a variety of reasons, including the installation of replacement or alternate tires or wheels on the vehicle that prevents the TPMS from functioning properly. Always check the TPMS malfunction indicator after replacing one or more tires or wheels on your vehicle to ensure that the replacement or alternate tires and wheels allow the TPMS to function properly.

*Note:* If a tire has been repaired using tire sealant and low tire pressure is detected, it's possible that the TPMS has been damaged.

---

Contact a **Lucid Service Center** to have the issue rectified as soon as possible.

### **Tire pressure correction**

The tire pressure indicator light does not automatically turn off when the tire pressure is adjusted for all four tires.

After the tires are inflated to the correct pressures, drive your vehicle over 18 mph (30 km/h) to activate the Tire Pressure Monitoring System (TPMS) and turn off the low tire pressure indicator light.

### **Tire changing**

Always have your tires serviced or changed by a qualified technician.

Care must be taken to avoid contact between the bead of the tire and the sensor during removal and refitting of the tire, otherwise the sensor may become damaged and/or inoperable.

### **Replacing a tire pressure sensor**

If you experience frequent low tire pressure warnings and the tire pressures are correct, contact **Lucid Service Center** to determine if a tire pressure sensor requires replacement.

*Note:* If a non-Lucid Service Center has replaced a tire pressure sensor, it may not work until it has been programmed to the vehicle by **Lucid**.

# Vehicle Loading

## Loading the Vehicle

- **WARNING:** Overloading the vehicle has an adverse effect on braking and handling characteristics, which can compromise your safety or damage the vehicle.

It is important to understand the maximum weight rating for your vehicle and how much weight your vehicle can safely carry.

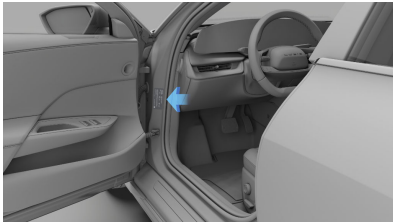

See the vehicle certification label located on the driver side front door jamb, by the front wheel, for the maximum load for your vehicle's Gross Vehicle Weight Rating (GVWR)

*Note:* Gross Vehicle Weight Rating (GVWR) is also known as the total allowable mass of the vehicle. This weight includes the vehicle's curb weight, all occupants, cargo, and any additional equipment installed on the vehicle since it was manufactured.

- **CAUTION:** To prevent severe damage to the vehicle, never load the vehicle to be heavier than the GVWR.

## Carrying items

- **WARNING:** The frunk and trunk are the preferred places to carry objects. In an accident, during hard braking, or sudden maneuvers, loose items carried in the vehicle's cabin area can be thrown around and cause injury to occupants.
- **CAUTION:** Heavy loads should be evenly distributed throughout the vehicle so as not to exceed the Gross

Axle Weight Ratings (GAWR) shown on the vehicle certification label. Refer to the tire information and loading label in the next section to determine the recommended maximum allowable weight that can be added to the vehicle to safely operate it and not damage the vehicle.

## Towing a trailer

- **WARNING:** Do not tow a trailer with your vehicle. The vehicle has not been designed to have a trailer hitch fitted to it. The installation of a trailer hitch may cause serious damage to the vehicle, which could result in an accident or serious injury.

## Steps for Determining Correct Load Limit

1. Locate the statement "The combined weight of occupants and cargo should never exceed xx kg or xx lb" on your vehicle's placard (Tire information and loading label).
2. Determine the combined weight of the driver and passengers that will be riding in your vehicle.
3. Subtract the combined weight of the driver and passengers from the never exceed weight identified in step 1.
4. The resulting figure equals the available amount of cargo and luggage load capacity. For example, if the total amount equals 950 lb (431 kg), and there will be five 150 lb (68 kg) passengers in the vehicle, the amount of available cargo and luggage capacity is 200 lb (91 kg) (950-750 (5x150) = 200 lb).
5. Determine the combined weight of luggage and cargo being loaded on the vehicle. That weight may not safely exceed the available cargo and luggage load capacity calculated in Step 4.

---

### Example load limit calculations

The number and weight of passengers will affect the weight of available cargo and luggage load capacity.

The following are typical examples of calculated load limits.

Description	Total
Vehicle Capacity Weight =	950 lb (431 kg)
Subtract Occupant Weight (2 x 150 lb) =	300 lb (136 kg)
Available Cargo or Luggage Weight =	650 lb (295 kg)

Description	Total
Vehicle Capacity Weight =	950 lb (431 kg)
Subtract Occupant Weight (4 x 150 lb) =	600 lb (272 kg)
Available Cargo or Luggage Weight =	350 lb (159 kg)

*Note:* Calculations for the available cargo and luggage capacity assume that the passengers weigh 150 lb (68 kg). If the passengers weigh more than this, the available cargo and luggage load capacity will decrease.

# Technical Data

# Vehicle Dimensions and Weights

## Exterior Dimensions

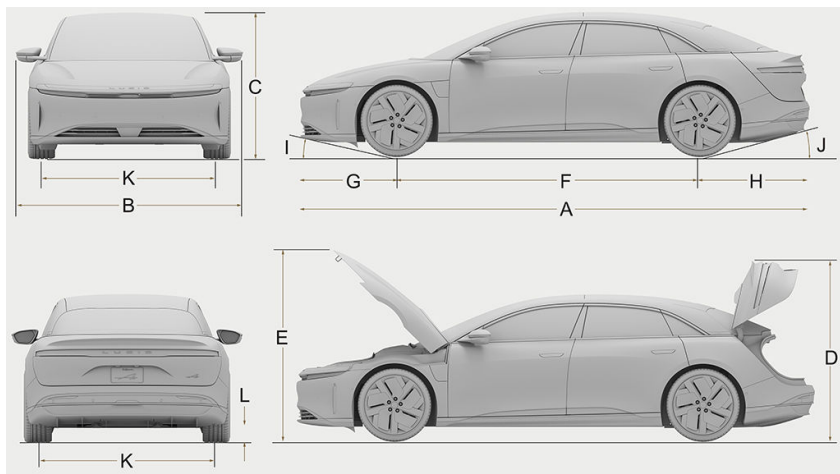

Identifier	Description	Dimensions (19" / 21")
A	Overall length	196 in (4975 mm)
B	Overall width - mirrors included	86 in (2196 mm)
C	Overall height	55 / 56 in (1408 / 1414 mm)
D	Overall height - deck lid open	68 / 69 in (1737 / 1747 mm)
E	Overall height - hood open	72 / 75 in (1859 / 1842 mm)
F	Wheelbase	117 in (2960 mm)
G	Front overhang	37 in (941 mm)
H	Rear overhang	42 in (1075 mm)
I	Approach angle	11/ 11°
J	Departure angle	13 / 14°
K	Track - front	65 / 66 in (1665 / 1669 mm)
	Track - rear	67 / 66 in (1689 / 1666 mm)
L	Ground clearance	5 in (126 / 136 mm)

## Vehicle Weights

Curb Weight* (19" / 21")	5205 lbs (2560 kg) / 5256 lbs (2575 kg)
Gross Vehicle Weight Rating (GVWR)	6285 lbs (2850 kg)
Gross Axle Weight Rating (GAWR) - Front	5153 lbs (1430 kg)
Gross Axle Weight Rating (GAWR) - Rear	5197 lbs (1450 kg)
Trailer towing	Not permissible

\*Curb Weight = Weight of vehicle with correct fluid levels, no occupants, and no cargo



---

# Wheels and Tires

## Wheel and Tire Specifications

Wheel Type	Position	Size
Standard production wheels		
19" - Acro Range	Front	19x8"
	Rear	19x8"
21" - Acro DREAM	Front	21x8.5"
	Rear	21x9.5"
Lug nut torque	150 Nm	
Lug nut socket size	21 mm	

Note: For details on where to lift your vehicle, see [Lifting the Vehicle](#) on page 168.

Tire Type	Position	Size	Load Index / Speed Rating
Standard production-installed tires			
19" - Pirelli PZero - All Season	All	245/45R19	XL / 102Y
21" - Pirelli PZero - Summer	Front	245/55R21	HLC / 99Y
	Rear	265/55R21	HLC / 105Y

---

## Tire Pressures

---

### Recommended COLD inflation pressures

---

Tire pressures may vary depending on the type of tires fitted to your vehicle. Refer to the tire pressures printed on the Tire and Loading Information label. This label is located on the left door pillar and is visible when the front door is open. See [Maintaining Tire Pressures](#) on page 177.

---

# Vehicle Sub-Systems

## Steering

---

Type	Rack and pinion with electronic power steering and speed sensitive assist.
Number of turns lock to lock	2.5 turns
Turning circle (curb to curb)	59 ft (11.9 m)

Brakes

Type	4-wheel anti-lock braking system (ABS) with Electronic Brake Force Distribution, Integrated Electronic Stability Control and electronic accelerator pedal-actuated regenerative braking system.
Calipers	Front: six-piston fixed Rear: four-piston fixed
Rotors	Ventilated front and rear rotors. Front diameter: 15 in (380 mm) Rear diameter: 14.75 in (375 mm)
Front rotor thickness	New: 1.5 in (38 mm) Service limit: 1.4 in (36 mm)
Rear rotor thickness	New: 1.18 in (30 mm) Service limit: 1.10 in (28 mm)
Front brake pad thickness	New: 0.45 in (11 mm) Service limit: 0.08 in (2 mm)
Rear brake pad thickness	New: 0.55 in (9 mm) Service limit: 0.08 in (2 mm)
Parking brake	Integrated electronically actuated motor-on-caliper

---

Front Suspension

---

Type	Independent 5-link with stabilizer bar		
Alignment	CAMBER	CASTER (for inspection, not adjustable)	TOE
optimum	-0.57°	7.5°	0.146°
tolerance	+0.25°	+0.5°	+0.05°
	-0.25°	-0.5°	-0.05°

Rear Suspension

Type	Independent integral link with stabilizer bar	
Alignment	CAMBER (for inspection, not adjustable)	
	optimum	-1.27°
	tolerance	+0.5°
		TOE
		0.110°
		+0.05°
		-0.05°

---

Motors

---

Front Permanent Magnet AC Motor

---

Rear Permanent Magnet AC Motor

---

Transmission

---

Drive Ratio 7.06:1 single speed

---

12V Batteries

---

Type Deep Cycle

---

Quantity 2

---

Rating 18 Ah

---

Voltage and polarity 12V Negative (-) ground

---

High-Voltage Battery

---

Type	Lithium ion (Li-ion)
------	----------------------

---

Cooling	Liquid-cooled
---------	---------------

# Roadside Assistance & Emergency Information



---

# Roadside Assistance

## Contacting Roadside Assistance

---

**Lucid** is committed to providing excellent service. Our Roadside Assistance Program is available 24 hours a day, 365 days a year. For assistance call::

+1 888-995-8243 (888-99-LUCID)

Advise the representative of:

- Vehicle identification number (VIN)
- Vehicle description
- License plate number
- Problem with the vehicle
- Your location

Lucid ensures appropriate transportation of its vehicles under the Lucid Roadside Assistance Program. However, it is your responsibility to provide the vehicle transporter with instructions on how to transport the vehicle. See [Transporting the Vehicle](#).

### Services Covered

The following are covered at no charge for four years or 50,000 miles, whichever comes first:

- Emergency Towing/Transport Service for warranty repairs to the nearest authorized Lucid Service Center
- Roadside service
- Flat Tire
- 12v Battery

Within the first year of ownership, Lucid will also provide towing and transport to an authorized Collision Repair facility in the event of an accident.

# Instructions for Transporters

## Transporting the Vehicle

- **CAUTION:** Towing the vehicle with the wheels on the ground or on a suspended lift may cause serious damage to the vehicle as well as generate high voltages in the vehicle's electrical components.

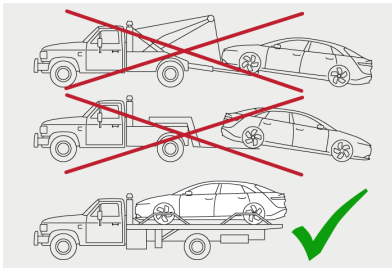

The only towing method approved by **Lucid** for recovering or transporting an undrivable vehicle is using a flatbed tow truck.

**Note:** The warranty will not cover damage caused by any other non-approved recovery method.

## Preparing the Vehicle for Transportation

- **CAUTION:** In the unlikely situation in which the vehicle's electrical systems are not functioning and cannot engage the parking brake, it is preferable to use wheeled dollies or skid pads under the rear wheels to prevent damage to the vehicle.

The vehicle automatically applies the parking brake whenever it is in P (Park) or detects that the key fob is no longer in the vehicle.

- **CAUTION:** The vehicle moves silently. Never assume it is powered off. Properly immobilize.

- Always chock wheels

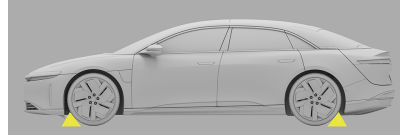

- Engage parking brake if it is not already applied.

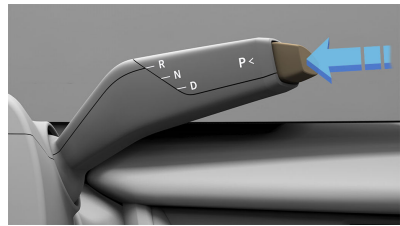

When lifting or stabilizing the vehicle, **ONLY** use the designated lift areas, as indicated by the location of arrows.

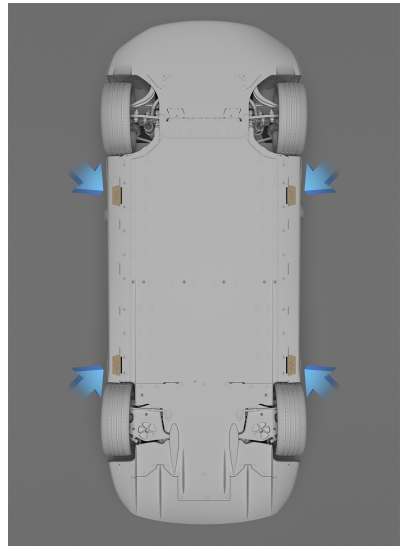

---

## Tow Truck Mode

When loading and unloading the vehicle onto a flatbed tow truck, put the vehicle in Tow Truck Mode. This can be done on the Pilot Panel by navigating to Settings > Vehicle and toggling Tow Truck Mode.

Tow Truck Mode disables the emergency parking brake, disables the alarm, and shifts the vehicle into neutral to allow for transport on and off the flatbed truck.

Lucid recommends that Tow Truck Mode remain active until after transportation has been completed.

---

### Pulling the Vehicle onto a Trailer or Transporter

---

- **CAUTION:** Under no circumstances should the vehicle be towed using the vehicle recovery eye. Doing so can cause significant damage to your vehicle.
- **CAUTION:** Incorrect installation of the recovery eye can cause it to become detached while pulling the vehicle, resulting in significant damage.
- **WARNING:** If the recovery eye mount is not accessible and the vehicle is recovered by attaching to a frame, suspension, or other means, the vehicle may sustain damage. Inspect the vehicle and ensure it is safe to operate. The Towing provider **MUST** document the method of vehicle recovery, whether using the recovery eye, attachment to the body, suspension, or other means. Failure to do so could result in a hazardous situation when operating the vehicle.

The recovery eye is available in the trunk of your vehicle and located on the underside of the right-hand floor panel.

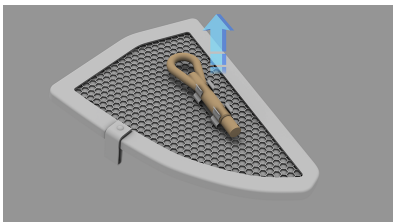

To install the recovery eye:

1. Release the rubber cover from the attachment point behind the front grille.

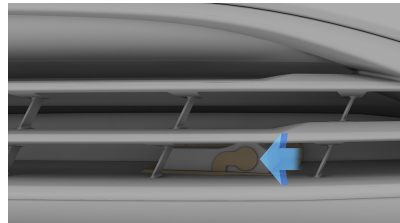

2. Position the recovery eye through the bumper and rotate it clockwise into the attachment point on the body until it is fully seated. Visually check that the recovery eye is parallel to the ground to ensure correct installation.

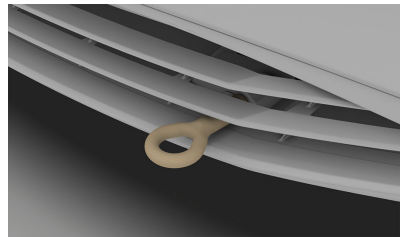

3. Attach the winch cable to the recovery eye.
4. Place the vehicle in Neutral (N) or support rear wheels on a self-loading dolly (see manufacturer instructions for use).
5. Pull the vehicle slowly onto the trailer or transporter.

*Note:* After using the recovery eye, remember to store it back in the trunk and install the rubber cover on the attachment point.

---

### Securing the Vehicle for Transportation

---

When the vehicle is in position on the transporter or trailer, use chocks and tie-down straps to secure the wheels.

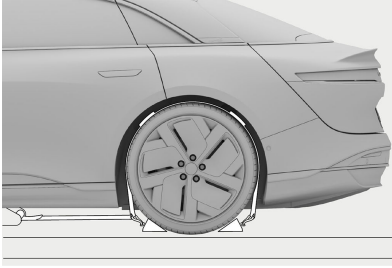

To avoid damage:

- Ensure that metal parts on tie-down straps do not contact the vehicle's painted surfaces or the face of any wheels.
- Do not place straps over or through the vehicle's body panels.
- **CAUTION:** Attaching straps to the chassis, suspension, or other parts of the body can damage the vehicle.

After securing the vehicle on the transporter or trailer, use the Pilot Panel to select P (Park). Doing so will engage the parking brake.

Opening Hood without 12V Power

---

Remove front wheel liners and double-pull the hood release on each side of the vehicle.

---

# Disabling the Power System

## Safety Precautions

---

- **WARNING:** In the event of fire, immediately contact your local fire emergency responders.
- **WARNING:** ALWAYS ASSUME THAT HIGH-VOLTAGE COMPONENTS ARE ENERGIZED. Cutting, crushing, or touching high-voltage components can result in serious injury or death.
- **WARNING:** High-voltage cables and components may remain energized for up to 2 minutes after disabling.
- **WARNING:** High-voltage batteries can self-ignite even after extinguishing the initial fire.
- **WARNING:** The airbags and other supplemental restraint systems may remain powered for up to 2 minutes after disabling.
- **WARNING:** In the event of a fire involving a charging station, treat it as an energized electrical fire until power to the charger is confirmed to shut off.
- **WARNING:** This vehicle does not have an internal combustion engine. Lack of engine noise does not mean the vehicle is OFF. Silent movement capability exists until the vehicle completely shuts down.

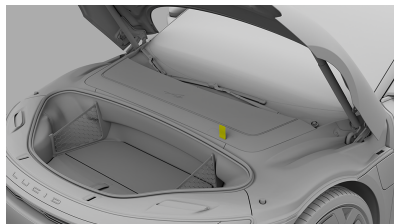

You can determine the location of the cut loop by the yellow label wrapped around it. This label is visible even with the maintenance access panel in place.

Double cutting and removing the emergency responder cut loop shuts down both the high-voltage and the 12-volt battery systems.

*Note:* The cut loop is a low-voltage (12V) cable.

## Emergency Responder Cut Loop

---

You can locate the emergency responder cut loop under the hood on the right side, near the suspension strut tower.

# Vehicle Fire

## Firefighting

---

- **WARNING:** When a fire is involved, consider the entire vehicle to be energized. Always wear full personal protective equipment (PPE), including a self-contained breathing apparatus (SCBA).
- **WARNING:** Extinguishing any vehicle fire is best accomplished by firefighting professionals. Contact your local authorities or fire department for help.

A vehicle battery fire presents a risk of exposure to high heat or toxic gases. It can take copious amounts of water applied directly to the battery to extinguish and cool a battery fire. Establish or request an additional water supply from nearby sources.

In the absence of a water supply, use dry chemicals, such as Carbon dioxide (CO<sub>2</sub>), foam, or any other typical fire-extinguishing agent, to fight the fire until a water supply is available.

Extinguishing smaller fires that do not involve a high-voltage battery follows the standard firefighting procedures.

A burning or a heated battery releases toxic vapors. Responders should always protect themselves with full PPE (including a SCBA) and take appropriate measures to protect civilians from the incident. Use fog streams or positive-pressure ventilation fans (PPV) to direct smoke and vapors away from other responders and civilians.

### After knock down

Make sure any fires are knocked down before entering a hot zone. Heat combined with flames can compromise the airbag inflators, stored gas inflation cylinders, gas struts, and other components, resulting in an unexpected explosion.

During vehicle inspections, always use insulated tools and do not make contact with any high-voltage components.

Use a thermal imaging camera to measure the temperature of the high-voltage battery and monitor heating or cooling trends. Before releasing the vehicle to second responders (such as law enforcement or vehicle transporters) or otherwise leaving the incident, completely cool the battery with no fire, smoke, or heating present for at least one hour. Always notify second responders of the risk of battery re-ignition.

13

# Consumer Information

# New Vehicle Limited Warranty

Message to Customers

Welcome to the Lucid New Vehicle Limited Warranty, and welcome to luxury electric. This guide provides a detailed explanation of the warranty terms for the Lucid Air, including coverage types, durations, limitations, regions, and more. Our goal is to provide peace of mind and exceptional service at every step of the Lucid Air ownership experience.

Who is the Warrantor?

Lucid USA, Inc. is the warrantor in the United States and Lucid Motors Canada ULC is the warrantor in Canada (collectively "Lucid"). Lucid will provide repairs to Lucid Airs sold by and delivered directly from Lucid or its affiliates during the applicable warranty periods in the specified Warranty Regions listed below in accordance with the terms, conditions and limitations in this Lucid New Vehicle Limited Warranty.

Warranty Region	Warrantor and Contact Information
USA	<p>Lucid USA, Inc.</p> <p>7575 Gateway Blvd</p> <p>Newark, CA 94560</p> <p>Phone: 1-888-99 LUCID (1-888-995-8245)</p>
Canada	<p>Lucid Motors Canada ULC</p> <p>Suite 2500, Bentall 5, 550 Burrard Street Vancouver BC, V6C 2B5</p> <p>Phone: 1-888-99 LUCID (1-888-995-8245)</p>

The Lucid New Vehicle Limited Warranty is valid only within the region for which the Lucid Air was originally manufactured and sold. Any service required under the terms of this Lucid New Vehicle Limited Warranty will be provided by a Lucid Service Center.

You may take your Lucid Air temporarily to any region where there is a Lucid Service Center,

and the Lucid Warranty will be honored in that region. Temporary is defined as a period less than six months. Proof of compliance with any temporary import laws or regulations is required. If you are permanently moving to a new region supported by a Lucid Service Center, you may apply to Lucid to transfer the Lucid Warranty to the region for the duration of your ownership. Requests to transfer a vehicle's Lucid Warranty will be decided on a case-by-case basis by Lucid at its absolute discretion, and will be subject to certain conditions, including all necessary regional modifications being carried out by a Lucid Service Center at the owner's cost.

Transfer of the Lucid Warranty to a new region is not permitted for subsequent purchasers. Lucid will not transfer the warranty coverage following the sale of a vehicle within the new region.

Who May Use This Limited Warranty?

This Lucid New Vehicle Limited Warranty is provided to the original and subsequent owner(s) of a new Lucid Air sold by Lucid or its affiliates in a specific warranty region, titled or registered in the name of the first retail owner or subsequent owner. The Lucid New Vehicle Limited Warranty can be transferred from the original owner to a subsequent owner—the new owner must provide proof of ownership transfer.

What Does This Limited Warranty Cover?

Your Lucid New Vehicle Limited Warranty gives you specific legal rights. You may have other rights that vary from jurisdiction to jurisdiction. This Lucid New Vehicle Limited Warranty provides limited warranty coverage for your Lucid Air.

Under this Lucid New Vehicle Limited Warranty, Lucid will, without charge and as determined by Lucid at its discretion, repair, replace, or adjust all parts on your new vehicle that malfunction or fail during normal use during the applicable coverage period due to a manufacturing defect in factory-supplied materials or factory workmanship provided your vehicle has been properly



operated and maintained in accordance with all requirements in the owner's manual and any other documentation we may provide you, and was taken to a Lucid Service Center for a warranted repair during the warranty period. It is the responsibility of the owner of the vehicle to present any concerns to a Lucid Service Center in the Warranty Region in a timely manner.

The remedy under this Lucid New Vehicle Limited Warranty, and any implied warranty, is limited to repair, replacement, or adjustment of defective parts. This exclusive remedy shall not be deemed to have failed of its essential purpose so long as Lucid, through its authorized service centers, is willing and able to repair, replace, or adjust defective parts as described in this Lucid New Vehicle Limited Warranty. Lucid's liability, if any, shall in no event exceed the cost of correcting manufacturing defects as provided in this written warranty. Upon expiration of this warranty, any such liability shall terminate.

This Lucid New Vehicle Limited Warranty agreement applies to vehicles manufactured and sold by Lucid or its affiliates in the country the vehicle was first purchased. The Lucid New Vehicle Limited Warranty provides the following types of coverage:

Warranty Type	Coverage Duration
Vehicle	4 Years / 50,000 miles
Powertrain	8 Years / 100,000 miles
High Voltage Battery	8 Years / 100,000 miles retaining 70% capacity
Corrosion Perforation	10 Years / Unlimited miles
Body and Paint Repair	4 Years / Unlimited miles
Supplemental Restraint System (SRS)	5 Years / 60,000 miles

Lucid warrants each new vehicle in accordance with the model version of the vehicle at the time of production. Lucid reserves the right to make modifications to vehicles manufactured or sold by us at any time, without notice.

#### New Vehicle Limited Warranty

The New Vehicle Limited Warranty covers the repair, replacement, or adjustment of parts necessary to correct defects in the materials or workmanship of any parts manufactured or supplied by Lucid under normal use for a period of four years or 50,000 miles (80,000 km), whichever comes first, subject to the exclusions and limitations and the separate coverage for certain parts described in this New Vehicle Limited Warranty. In addition, any repair, replacement, or adjustment of parts or components is covered under this New Vehicle Limited Warranty if damaged or made inoperable due to a defect caused by a Lucid over-the-air update during the warranty period.

If it is determined that your vehicle requires warranty repair, Lucid will repair, replace, or adjust the applicable vehicle part with a new, reconditioned, or remanufactured part at the discretion of Lucid.

#### Powertrain Limited Warranty

The Powertrain is covered for the duration of 8 years or 100,000 miles (160,000 km), whichever occurs first. The Powertrain Limited Warranty will cover the cost of repair, replacement, or adjustment of the defective parts of the Lucid powertrain subject to the limitations outlined in this New Vehicle Limited Warranty. This coverage is for Lucid's sophisticated electric powertrain, including the fully integrated electric drive units, transmission, and differential.

If it is determined that your powertrain requires warranty repair, Lucid will repair, replace, or adjust the part with a new, reconditioned, or remanufactured part at the discretion of Lucid.

#### Battery Limited Warranty

The high voltage battery is covered for the duration of 8 years or 100,000 miles (160,000 km), whichever occurs first, with a minimum 70% retention of battery capacity over the warranty period. The Battery Warranty covers the cost of repair, replacement, or adjustment of a defective Lucid battery at the discretion of Lucid, subject to the limitations outlined in this New Vehicle Limited Warranty.

The high voltage battery, like all batteries, will experience a decrease of energy and power loss with time and use. Loss of energy or power reduction over time is not covered beyond the terms and limits of this warranty, as set forth in the paragraph above. Proper storage and maintenance of your Lucid vehicle will maximize the life and capacity of the battery. Failure to follow the recommended guidelines and charging procedures as stated in the Lucid Owner's Manual will not be covered under the terms of this limited warranty. Please refer to the Owner's Manual for additional information.

Please note that the vehicle's displays of range are estimates based on driving conditions and habits, including other factors that are independent from the vehicle's battery capacity. The measurement method used to determine the battery capacity is at the sole discretion of Lucid's trained and authorized representatives.

If it is determined that your battery requires warranty repair, Lucid will repair, replace, or adjust the part with a new, reconditioned, or remanufactured part at the discretion of Lucid. However, Lucid will ensure that the capacity of the battery will be equal or greater than the original battery capacity during the warranty claim.

Corrosion Perforation Limited Warranty

The Lucid Corrosion Perforation Limited Warranty covers perforation of body panels from within to the outside of the panel resulting from a material or manufacturing defect for 10 years (there is no mileage limitation on this coverage), except where:

- Surface corrosion occurs due to paint damaged by scratches, stone chips, or environmental fallout such as bird droppings or acid rain.
- The application of non-Lucid approved third-party coatings that have a detrimental effect on the original painted surface or under body panels.
- Corrosion is caused by, due to, or resulting from accidents, abuse, neglect, improper maintenance or operation of the vehicle, installation of a non-approved accessory, exposure

to chemicals or environmental contaminants, damage resulting from an act of God or nature, fire, or improper storage.

- Damage is due to lack of required maintenance; improper maintenance; the use of other than original equipment parts, non-approved parts, or fluids; or improper body repairs.
- Repairs have not been performed by a Lucid Service Center or Lucid approved body shop.

Supplemental Restraint System (SRS) Limited Warranty

The Supplemental Restraint System Limited Warranty covers defects in the seat belts or air bags system resulting from material or manufacturing defect for 5 years or 60,000 miles (100,000km), whichever comes first.

What Does This Limited Warranty Not Cover?

**Wear and Tear Items**

The Lucid New Vehicle Limited Warranty does not cover any item where its failure is due to normal wear and tear or items that have to be replaced or adjusted periodically during routine servicing and maintenance, including paint and glass chips, key fob batteries, upholstery discoloration, tears, punctures, wrinkles, depressions or other similar items.

The term "wear and tear" describes the normal process by which the components reach the limit of serviceability through normal use. The service life of a wearing part depends on the type of use of the vehicle and individual style of driving. As such, any component which has been repaired, replaced, or adjusted once under this Lucid New Vehicle Limited Warranty is not covered again, unless the failure is due to a manufacturing defect.

Items subject to normal wear and tear include, but are not limited to:

- Brake discs and pads
- Wiper blades
- Seat and back rest covers

- Upholstery and trim
- Steering Wheel
- Floor coverings

Service parts include, but are not limited to:

- Filters
- Lubricants
- Items replaced during routine maintenance

Service adjustments required after the first service, including but not limited to:

- Adjustment to doors and hoods
- Head lamp adjustment
- Wheel alignment
- Wheel balancing

### **Tires**

The original factory fitted tires are covered against manufacturing defects by the tire manufacturer, who provides a separate warranty to you with its own terms and conditions. Warranty claims must be made directly with the tire manufacturer. The Lucid New Vehicle Limited Warranty does not cover tires.

### **Performance Modifications**

The Lucid New Vehicle Limited Warranty does not cover any repair, replacement, or adjustment of parts where the fault or defect is wholly or partially attributed to performance related modifications.

### **Performance Metrics**

Performance metrics advertised by Lucid and/or other testing agencies are not covered under the Lucid New Vehicle Limited Warranty as there are many variables that may affect the vehicle performance, including but not limited to vehicle age/use, ambient temperature, battery state of charge. Please refer to the Owner's Manual for additional information.

### **Removal of Non-Standard Equipment or Accessories**

Additional labor time for the removal of non-standard equipment, including but not limited to aftermarket parts and accessories, and Lucid Accessories cannot be claimed under the Lucid New Vehicle Limited Warranty.

### **Track and Competition Use**

Track and Competition use is not covered under the Lucid New Vehicle Limited Warranty.

### **Normal Noise and Vibration**

All mechanical devices produce some level of noise and/or vibration that can differ between vehicles. Slight wind noise, component noise, and/or vibration that do not affect the performance of the vehicle are considered normal and are not covered by the Lucid New Vehicle Limited Warranty.

### **Commercial Use as a Taxi or Ride Sharing Service**

The Lucid New Vehicle Limited Warranty does not cover Lucid vehicles being used to provide taxi or ride sharing services.

### **Insurance Write-off**

A Lucid vehicle is not covered by the Lucid New Vehicle Limited Warranty if the vehicle has been damaged to such an extent that an insurer, financing institution, or leasing company determines the Lucid vehicle to be a "total loss," "write off," or equivalent. This includes, but is not limited to, vehicles branded as "salvage," "scrap," "dismantled," or similar titles.

### **Other Damage**

Damage caused by any of the following items or actions listed below is not covered under this Lucid New Vehicle Limited Warranty:

- Accidents, collision or objects striking the vehicle
- Theft, vandalism, or riot
- Vehicle damage due to external incidents

- Customer-applied chemicals or accidental spills, including sunscreen or hairspray
- Driving through water deep enough to cause water to infiltrate into any component, for example, powertrain components
- Installation of parts that are not Lucid Genuine Parts
- Immersion/flooding of the high voltage battery assembly
- Abuse and/or misuse of the vehicle and/or high voltage battery pack, such as driving over curbs, overloading, racing or track use
- Any unauthorized access or modification of vehicle software or data through the use of, but not limited to, non-Lucid software programs, malware, programming errors, or any electronic disruptions.
- Permitting water to enter the vehicle by leaving a window or door open
- Exceeding the load limits specified on the certification label
- Failure to observe and resolve vehicle warnings and indications of battery concerns within a reasonable amount of time
- Failure to complete software updates within a reasonable amount of time, typically 30 days
- The use of incompatible charging devices or methods
- Modifications to the vehicle, high voltage battery assembly, high voltage system, or associated wiring
- Exposure to direct and/or intense heat sources outside of normal use
- Allowing the high voltage battery assembly to remain in a fully discharged, or near zero state of charge, for more than 14 days
- Repairs performed by facilities and personnel not authorized by Lucid,

including repairs which would have otherwise been covered under this Lucid New Vehicle Limited Warranty

- Improper vehicle storage resulting in high voltage battery damage

What Will Cause the Warranty to Be Voided?

---

The Lucid New Vehicle Limited Warranty will be voided, and no warranty coverage will be provided in the following situations:

- Failing to properly operate your vehicle in accordance with the specific instructions and recommendation regarding the use and operation of your vehicle as provided in the Owner's Manual.
- Failing to install required software updates within 30 days after notification that an update is available.
- Failing to comply with any recall notice.
- Defacing or altering the VIN or odometer or any related system such that it is difficult to determine the VIN number or actual mileage.
- The vehicle being sold, designated, labeled or branded as dismantled, fire-damaged, flood-damaged, junk, rebuilt, salvage, reconstructed, irreparable, or a total loss, including a determination by an insurance carrier that the vehicle is a total loss.

What to do if you need Roadside Assistance?

---

To obtain roadside assistance when your Lucid vehicle is inoperable, contact 1-888-995-8243. Roadside Assistance is an additional service offered by Lucid for four years or 50,000 miles, whichever comes first. It is a separate service and is not provided as part of the New Vehicle Limited Warranty. See [Contacting Roadside Assistance](#) on page 196 for more information.

What is the Coverage Period?

---

Coverage under this Lucid New Vehicle Limited Warranty begins on the date that the vehicle is delivered to the first retail or corporate purchaser (s) or lessor (s) or the day it is first put into service (in the case of

---

demonstrator vehicle), whichever occurs first and lasts until the time period as stated in the New Vehicle Warranty Coverage section of this guide.

#### What Are Your Remedies?

---

The Lucid New Vehicle Limited Warranty covers the rectification of reported defects covered by this warranty via repair, replacement, or adjustment of faulty parts or components, as determined by Lucid in its discretion. If a defect can be properly eliminated by repair, and this is the most economical course of action, then the Lucid Service Representative will complete the repair. Lucid may determine at its sole discretion that certain parts or components should be replaced rather than repaired.

For Lucid Genuine Spare Parts installed during a warranty repair, the warranty coverage ends at the expiration of the warranty period for that covered system.

For reported defects in the materials or workmanship of any parts manufactured or supplied by Lucid but not remedied within the warranty period, the Lucid Warranty coverage for that reported defect will continue until the reported defect is resolved. Such coverage will end:

- When the Lucid Service Representative confirms that the defect has been eliminated;
- When the Lucid Service Representative confirms that no fault exists; or
- Thirty days after you have been notified in writing that the Lucid Genuine Spare Parts required to carry out the repair are in stock at the Lucid Service Representative.

#### Limitations on Liability

---

To the fullest extent allowed by applicable law, all of the warranties in this Lucid New Vehicle Limited Warranty are subject to the following limitations and disclaimers:

**THE WARRANTIES IN THIS LUCID NEW VEHICLE LIMITED WARRANTY ARE THE ONLY EXPRESS WARRANTIES APPLICABLE TO YOUR VEHICLE. LUCID DOES NOT ASSUME OR AUTHORIZE ANYONE TO**

**ASSUME FOR IT ANY OTHER OBLIGATION OR LIABILITY IN CONNECTION WITH YOUR VEHICLE OR THESE WARRANTIES. NO PERSON MAY MODIFY OR WAIVE ANY PART OF THESE WARRANTIES.**

As a condition of these warranties, you are responsible for properly using, maintaining, and caring for your vehicle as outlined in your Owner's Manual. Lucid recommends that you maintain copies of all maintenance records and receipts for review by Lucid.

Any implied warranty of merchantability or fitness is limited, to the fullest extent allowed by applicable law, to the time period covered by these written warranties, or to the applicable time period provided by applicable law, whichever period is shorter.

To the fullest extent allowed by applicable law, Lucid disclaims all implied warranties if the vehicle is used for business or commercial purposes. To the fullest extent allowed by applicable law, Lucid disclaims the implied warranty of fitness for a particular purpose if your vehicle is used for racing, even if the vehicle is equipped for racing.

The warranties contained in this Lucid New Vehicle Limited Warranty and all questions regarding their enforceability and interpretation are governed by the law of the jurisdiction in which you purchased your Lucid vehicle. Some jurisdictions do not allow Lucid to limit how long an implied warranty lasts or to exclude or limit incidental or consequential damages, so the limitation and exclusions described above may not apply to you.

Lucid reserves the right to make changes in or additions to warranties for vehicles built or sold by them at any time without incurring any obligation to make the same or similar changes or additions to warranties for vehicles previously built or sold.

Lucid also reserves the right to provide post-warranty repairs, conduct recalls, or extend the warranty coverage period for certain vehicles or vehicle populations, at the sole discretion of Lucid. The fact that Lucid has provided such measures to a particular vehicle or vehicle population in no way obligates Lucid to provide similar measures to other owners of similar vehicles.

We take customer satisfaction seriously. If you have any questions or concerns, or are unsatisfied with the service you are receiving, follow these steps:

1. Contact your Lucid Service Representative at your local Service Center
2. If your inquiry or concern remains unresolved, contact the Sales Manager, Service Manager or Customer Care Manager at 1-888-99 LUCID (1-888-995-8243)

### What to Do in Case of Dispute (U.S. Only)

Customer satisfaction is very important to Lucid. If you have an unresolved warranty concern after following the procedure outlined above, U.S. owners may be eligible to utilize the BBB AUTO LINE, an out of court dispute resolution program administered by BBB National programs.

BBB AUTO LINE, administered by BBB National Programs  
1676 International Drive, Suite 550  
McLean, Virginia 22102  
1-800-955-5100 or [BBBAUTOLINE.org](http://BBBAUTOLINE.org)

This service is provided at no cost to you and is part of Lucid's effort to provide you with an impartial third-party organization to equitably resolve your concerns. BBB AUTO LINE provides voluntary mediation and non-binding arbitration services for disputes involving Lucid vehicles with an alleged nonconformity, defect, or deficient warranty performance, as determined by state or federal law.

You must bring the alleged defect to the attention of Lucid or an authorized Lucid dealer within the eligibility period defined by your local state law.

**IMPORTANT: YOU MUST USE BBB AUTO LINE PRIOR TO SEEKING REIMBURSEMENT AVAILABLE TO YOU THROUGH A COURT ACTION PURSUANT TO THE MAGNUSON-MOSS WARRANTY ACT ("THE ACT"). HOWEVER, IF YOU CHOOSE TO SEEK REMEDIES THAT ARE NOT CREATED BY THE ACT, YOU ARE NOT REQUIRED TO USE BBB AUTO LINE, ALTHOUGH THAT OPTION IS STILL AVAILABLE TO YOU. IN ADDITION, YOU MUST USE BBB AUTO LINE IF YOU ARE**

**REQUIRED TO DO SO PRIOR TO SEEKING REMEDIES UNDER THE "LEMON LAW" OF YOUR STATE, IF YOUR STATE REQUIRES YOU TO DO SO. PLEASE CONSULT THE BBB AUTO LINE PROGRAM FOR ELIGIBILITY AND TIME LIMITATIONS IN YOUR STATE.**

Please consult specific state laws for guidance about your specific state lemon law. However, if your state law permits, and if you choose to seek remedies that are not created by the Act, you are not required to use BBB AUTO LINE, although that option is still available to you.

NOTE: If your state law requires written notification to the manufacturer please write to:

Lucid Customer Care Center  
7373 Gateway Boulevard  
Newark, CA 94560

To begin the Alternative Dispute Resolution (arbitration) process, simply call BBB AUTO LINE at 1-800-955- 5100 or visit [BBBAUTOLINE.org](http://BBBAUTOLINE.org) to file a claim online. You will be provided a Customer Claim Form, along with information describing how BBB AUTO LINE works. Your vehicle's age, mileage and other limitations may apply. If you wish to use the BBB AUTO LINE program and you qualify for participation, you will be required to provide the following information:

- Your name and address;
- The vehicle identification number;
- The make, model and year of your vehicle; and
- A description of your concerns with the vehicle.

BBB AUTO LINE may also ask you for other information to help resolve your concerns, such as the purchase price of the vehicle, the mileage at the time of purchase, the current mileage and copies of repair orders. Upon receipt of your properly completed Customer Claim Form, BBB AUTO LINE will facilitate a voluntary mediation process for possible mutual resolution. If a mutual resolution is not possible, the matter will be resolved by non-binding arbitration. A decision is normally rendered within 40 days. BBB AUTO LINE will provide you a copy of the arbitrator's decision and, if you accept the decision,

---

all parties must comply with the decision within the time limits (performance date) set by the arbitrator. Approximately two weeks after the "performance date," BBB AUTO LINE will contact the consumer to verify that the arbitrator's decision has been completed.

BBB AUTO LINE's decisions do not include attorney's fees, civil penalties, punitive damages, multiple damages or consequential damages other than incidental damages which you may be entitled to under law. If you reject the decision of the arbitrator, you may pursue other legal remedies under state or federal law, and the company will not be obligated to perform any part of the decision. Depending on federal or state law, the decision may or may not be introduced as evidence by the consumer or the company in any civil court action relating to any matter that has been resolved in your arbitration hearing, and BBB AUTO LINE involvement in the case will end as well.

#### **What to Do in Case of Dispute (Canada Only)**

Customer satisfaction is very important to Lucid. If you have an unresolved warranty concern after following the procedure outlined above, Canadian owners may be eligible to utilize the Canadian Motor Vehicle Arbitration Plan (CAMVAP), which is a neutral, out-of-court dispute resolution program. More information about CAMVAP can be found here:

Canadian Motor Vehicle Arbitration Plan

235 Yorkland Boulevard, Suite 109, Toronto,  
ON M2J 4Y8

<https://www.camvap.ca/>

CAMVAP provides binding arbitration services for disputes involving Lucid vehicles with an alleged nonconformity, defect, or deficient warranty performance, as determined by provincial or federal law. This service is provided at no cost to you and is part of Lucid's effort to provide you with an impartial third-party organization to equitably resolve your concerns.

To begin the arbitration process, simply call CAMVAP toll-free at 1-800-207-0685. CAMVAP will connect you with the proper Provincial Administrator based on the area code from which you are calling.

The process of resolving disputes through CAMVAP takes about 70 to 90 calendar days. To ensure fast and fair resolution of disputes that avoid the cost of going to court, CAMVAP's decision is final and binding on Lucid and you. CAMVAP's decisions do not include attorney's fees, civil penalties, punitive damages, multiple damages, or consequential damages other than incidental damages to which a party may be entitled under law.

# Customer Care

## Contacting Lucid Motors

---

Please have the following details available when contacting Lucid Motors. They are essential to effectively and efficiently answer your questions or resolve your concerns.

- Owner's name and address
- Owner's telephone number
- Vehicle identification number (VIN)

Contact Lucid Motors using the information for your warranty region shown earlier in this section or as follows:

Lucid Motors

7373 Gateway Blvd

Newark, CA 94560

USA

Phone: +1 (888) 995-8243

Monday-Friday 8 am to 5 pm (Pacific Time)

E-mail: [support@lucidmotors.com](mailto:support@lucidmotors.com) (24 hours)

For updates and additional information about your vehicle, visit the owner resources section of the Lucid Motors website: [www.lucidmotors.com](http://www.lucidmotors.com)



---

# Reporting Safety Defects

United States

---

If you believe that your vehicle has a defect which could cause a crash or could cause injury or death, you should immediately inform the National Highway Traffic Safety Administration (NHTSA) in addition to notifying **Lucid Motors**.

If NHTSA receives similar complaints, it may open an investigation, and if it finds that a safety defect exists in a group of vehicles, it may order a recall and remedy campaign. However, NHTSA cannot become involved in individual problems between you and **Lucid Motors**.

To contact NHTSA, you may call the Vehicle Safety Hotline toll-free at:

1-888-327-4236 (TTY: 1-800-424-9153);  
go to <https://www.nhtsa.gov/report-a-safety-problem#index>; or write to:

Administrator

National Highway Traffic Safety  
Administration

1200 New Jersey Avenue SE

Washington, DC 20590

You can also obtain other information about motor vehicle safety from:

<http://www.safercar.gov>

Canada

---

If you believe that your vehicle has a defect which could cause a crash or could cause injury or death, you should immediately inform Transport Canada, in addition to notifying **Lucid Motors**.

To contact Transport Canada, call their toll-free number:

+1-800-333-0510

# Disclaimers

## California Proposition 65



**WARNING:** Operating, servicing, and maintaining a passenger vehicle can expose you to chemicals, including phthalates, which are known to the State of California to cause cancer and birth defects, or other reproductive harm. To minimize exposure, wear gloves or wash your hands frequently when servicing your vehicle. For more information, go to [www.P65Warnings.ca.gov/passenger-vehicle](http://www.P65Warnings.ca.gov/passenger-vehicle).

## California Perchlorate Advisory

- **WARNING:** Certain components of this vehicle, such as lithium batteries, may contain perchlorate material. Special handling may apply for service or end-of-life disposal. See [www.dtsc.ca.gov](http://www.dtsc.ca.gov).

## Vehicle Telematics

Lucid Air is an advanced connected vehicle equipped with a host of advanced electronic control units (ECUs), each responsible for a specific set of features. The features span domains including controls, safety, infotainment, chassis, AD/ADAS, telematics, to name a few that contribute to functionality, performance, safety, and security of the vehicle.

In the process of its operation, each ECU monitors a set of sensors and controls a set of actuators depending on the role of the ECU. As a result, each ECU generates and collects data about the operational state, performance, anomalies, environment conditions, battery and charging related information, speed, direction, location, etc. The collected data are transmitted to the Lucid cloud services infrastructure on an ongoing basis over cellular wireless and wireless LAN networks. In addition, a portion of the data may be accessed by the technicians at the service center and stored in the Lucid information databases.

Lucid may use the vehicle data stored in the vehicle, databases in the service

centers, and cloud-based infrastructure to enhance its products and services, including but not limited to vehicle maintenance, troubleshooting, timely service recommendations & reminders, additional feature recommendations, research and development, and marketing & business analysis purposes. Lucid Air has the over-the-air (OTA) software update capability to keep the vehicle software current and improved. Lucid may use the vehicle data to update vehicle software improvements OTA to avoid issues proactively before they occur on the vehicle.

Please see [Lucid's Vehicle Data Privacy Policy](#) and [Privacy Policy](#) for additional details about how Lucid collects and processes data collected from the vehicle.

## Data Recording

### Service data recording

Service data recorders in your vehicle are capable of collecting and storing diagnostic information about your vehicle. This potentially includes information about the performance or status of various systems and modules in the vehicle such as the high-voltage battery, electric motors, accelerator, steering, or brakes. In order to properly diagnose and service your vehicle, a **Lucid Service Center** or other service facilities may access vehicle diagnostic information through a direct connection to your vehicle.

### Event data recording

This vehicle is equipped with an event data recorder (EDR). The main purpose of an EDR is to record, in certain crash or near crash-like situations, such as an air bag deployment or hitting a road obstacle, data that will assist in understanding how a vehicle's systems performed. The EDR is designed to record data related to vehicle dynamics and safety systems for a short period of time, typically 30 seconds or less. The EDR in this vehicle is designed to record such data as:

- How various systems in your vehicle were operating;

- 
- Whether or not the driver and passenger safety belts were buckled/fastened;
  - How far (if at all) the driver was depressing the accelerator and/or brake pedal; and,
  - How fast the vehicle was traveling.

These data can help provide a better understanding of the circumstances in which crashes and injuries occur.

*Note:* EDR data are recorded by your vehicle only if a non-trivial crash situation occurs; no data are recorded by the EDR under normal driving conditions and no personal data (e.g., name, gender, age, and crash location) are recorded. However, other parties, such as law enforcement, could combine the EDR data with the type of personally identifying data routinely acquired during a crash investigation.

To read data recorded by an EDR, special equipment is required, and access to the vehicle or the EDR is needed. In addition to the vehicle manufacturer, other parties, such as law enforcement, that have the special equipment, can read the information if they have access to the vehicle or the EDR.

*Note:* Services such as software updates and other subscriptions sometimes require transmission of vehicle data.

# Vehicle Recycling

## High-Voltage Battery Recycling Process

- **WARNING:** Attempting to disconnect or remove the battery pack without the proper training, tools, and equipment is highly dangerous and could result in serious injury or death.

Your vehicle is equipped with a liquid-cooled lithium ion (Li-ion) high-voltage battery pack. A battery pack must be properly recycled when it has been damaged or has reached the end of its useful service life.

If the vehicle can no longer hold a charge or power on, or in the case of a collision or submersion, contact a **Lucid Service Center** immediately. Have the battery pack removed from the vehicle by a Lucid Service Center or a **Lucid** approved technician as soon as possible. Do not attempt to disconnect or remove the battery pack yourself.

**Lucid Service Centers** will manage the damaged or depleted battery pack and, in accordance with Lucid's requirements, contact a qualified recycling company for recycling and disposal.

*Environmental:* Do not dispose of the battery pack yourself, as arbitrary disposal can cause pollution and harm to the environment.

Be sure to follow the information and requirements below:

1. **Personnel:** The HV battery removal operation must be performed by a **Lucid Service Center** technician or a **Lucid**-approved professional.
2. **Transportation:** The battery pack is classified as a hazardous material under Class 9 dangerous goods. If removed from the vehicle, these must be labeled, documented, and transported by licensed vehicles that meet all requirements for transporting Class 9 dangerous goods.
3. **Storage:** The removed battery pack should be stored in an environment that is protected from extreme temperatures and high humidity. Do not expose the removed battery pack to flammable

materials, heat sources, water sources, or other hazards.

For questions or further details on the recycling and disposal of a battery pack, please contact a **Lucid Service Center**. To locate a **Lucid Service Center**, please visit [www.lucidmotors.com](http://www.lucidmotors.com) for the latest information.

# FCC, FDA, and ISED Compliance

## FCC and ISED Certification

Component	Manufacturer	Model	Operating Frequency (MHz)	FCC ID / ISED ID
Bluetooth® Vehicle Key	Pektron Group Ltd	O15	2402-2480 MHz	AQ0015  IC: 10176A-015
Access Control Module BTLE/LF Node	Pektron Group Ltd	O12	125 KHz, 2402-2480 MHz	AQ0012  IC: 10176A-012
Access Control Module BTLE/LF/NFC Node	Pektron Group Ltd	O11	125 KHz, 15.56 MHz, 2402-2480 MHz, 15.56 MHz	AQ0011  IC: 10176A-011
Center Console Controller	Lucid USA, Inc.	K2B000	2402-2480 MHz, 5180.0-5240.0 MHz, 5260-5520 MHz, 5745.0-5825.0 MHz	2AXZJ-K2B000  IC: 27970-K2B000
Homelink Universal Garage Door Transmitter	Gentex Corp	ADHL5D	286-440 MHz, 902-927 MHz	NZLADHL5D  IC: 4H12A-ADHL5D
Long-Range Radar	Automotive Distance Control Systems GmbH	OAYARS5B	76-77 GHz	OAYARS5B  IC: 4I35A-ARS5-B
Wireless Phone Charger	JVIS USA LLC	1LCID550001	119.6 KHz	2AZX6-1LCID550001  IC: 27404-1LCID550001
Short Range Radar	Automotive Distance Control Systems GmbH	OAYSRR5B	76-77 GHz	OAYSRR5B  IC: 4I35A-ARS5-B
Telematics Control Unit	Lucid USA, Inc.	P11-K29000	2412.0-2462.0 MHz, 2502.5-2567.5 MHz, 5180.0-5240.0 MHz, 5745.0-5825.0 MHz, 699.7-715.5 MHz, 779.5-784.5 MHz, 824.2-848.8 MHz, 1710.7-1754.5 MHz, 1850.2-1909.8 MHz	2AXZJ-CTX0700  IC: 27970-CTX0700

Component	Manufacturer	Model	Operating Frequency (MHz)	FCC ID / ISED ID
Telematics Control Unit	Lucid USA, Inc.	PII-K290G0	2412.0-2462.0 MHz, 2502.5-2567.5 MHz, 5180.0-5240.0 MHz, 5745.0-5825.0 MHz, 699.7-715.3 MHz, 779.5-784.5 MHz, 824.2-848.8 MHz, 1710.7-1754.5 MHz, 1850.2-1909.8 MHz	2AXZJ-CTX0710  IC: 27970-CTX0710
Tire Pressure Monitoring System	Continental Automotive GmbH	TIS-01	455.92 MHz	KR5TIS-01  IC: 7812D-TIS01

Note: ISED compliance: CAN ICES-002/NMB-002

**FCC and ISED Notes: Wireless Charger-JVIS USA**

FCC ID: 2AZX6-1LCID350001

IC: 27404-1LCID350001

This device complies with part 15 of the FCC Rules. Operation is subject to the following two conditions:

1. This device may not cause harmful interference.
2. This device must accept any interference received, including interference that may cause undesired operation.

Changes or modifications not expressly approved by the party responsible for compliance could void the user's authority to operate the equipment.

This equipment has been tested and found to comply with the limits for a Class B digital device, pursuant to part 15 of the FCC Rules. These limits are designed to provide reasonable protection against harmful interference in a residential installation. This equipment generates, uses, and can radiate radio frequency energy and, if not installed and used in accordance with the instructions, may cause harmful interference to radio communications. However, there is no guarantee that interference will not occur in a particular installation. If this equipment does cause harmful interference to radio or television reception, which can be determined by turning the equipment off and on, the user is encouraged to try to correct the interference by one or more of the following measures:

- Reorient or relocate the receiving antenna.
- Increase the separation between the equipment and receiver.
- Connect the equipment into an outlet on a circuit different from that to which the receiver is connected.
- Consult the dealer or an experienced radio/TV technician for help.

**FCC and ISED Notes: Interior Radar**

FCC Interference Statement (Part 15.105 (b))

This equipment has been tested and found to comply with the limits for a Class B digital device, pursuant to Part 15 of the FCC Rules. These limits are designed to provide reasonable protection

---

against harmful interference in a residential installation. This equipment generates uses and can radiate radio frequency energy and, if not installed and used in accordance with the instructions, may cause harmful interference to radio communications. However, there is no guarantee that interference will not occur in a particular installation. If this equipment does cause harmful interference to radio or television reception, which can be determined by turning the equipment off and on, the user is encouraged to try to correct the interference by one of the following measures:

- Reorient or relocate the receiving antenna.
- Increase the separation between the equipment and receiver.
- Connect the equipment into an outlet on a circuit different from that to which the receiver is connected.
- Consult the dealer or an experienced radio/TV technician for help.

#### FCC Part 15 Clause 15.21

Changes or modifications not expressly approved by the party responsible for compliance could void the user's authority to operate the equipment

#### FCC Part 15.19(a)

This device complies with part 15 of the FCC Rules. Operation is subject to the following two conditions: (1) This device may not cause harmful interference, and (2) this device must accept any interference received, including interference that may cause undesired operation.

#### ISED RSS-Gen Notice

This device contains license-exempt transmitter(s)/receiver(s) that comply with Innovation, Science and Economic Development Canada's license-exempt RSS(s). Operation is subject to the following two conditions:

- This device may not cause interference.
- This device must accept any interference, including interference that may cause undesired operation of the device.

L'émetteur/récepteur exempt de licence contenu dans le présent appareil est conforme aux CNR d'Innovation, Sciences et Développement économique Canada applicables aux appareils radio exempts de licence. L'exploitation est autorisée aux deux conditions suivantes :

L'appareil ne doit pas produire de brouillage;

L'appareil doit accepter tout brouillage radioélectrique subi, même si le brouillage est susceptible d'en compromettre le fonctionnement.

#### ISED Canada ICES-003 Compliance Label

CAN ICES-3 (B)/NMB-3(B)

#### FCC/ISED RF Exposure requirements:

In order to comply with FCC/ISED RF Exposure requirements, this device must be installed to provide at least 20 cm separation from the human body at all times.

Pour être conforme avec les exigences sur les Radios Fréquence contenues dans le FCC/ISED, l'appareil doit être installé de sorte à être en permanence à au moins 20 cm de distance du corps humain.

**FCC and ISED Notes: TPMS System – Continental Automotive GmbH**

FCC ID: KR5TIS-01

IC: 7812D-TIS01

FCC Statements

FCC § 15.19 Labelling requirements

This device complies with part 15 of the FCC Rules and Industry Canada license-exempt RSS standard(s). Operation is subject to the following two conditions:

1. This device may not cause harmful interference.
2. This device must accept any interference received, including interference that may cause undesired operation.

FCC § 15.21 Information to user

Changes or modifications not expressly approved by the party responsible for compliance could void the user's authority to operate the equipment.

**FCC and ISED Notes: Universal Garage Door Opener Transmitter – Gentex Corp.**

FCC ID: NZLADHL5D

IC: 4112A-ADHL5D

FCC (USA) and IC (Canada):

This device complies with FCC rules part 15 and Industry Canada RSS-210. Operation is subject to the following two conditions:

1. This device may not cause harmful interference.
2. This device must accept any interference that may be received, including interference that may cause undesired operation.

- **WARNING:** The transmitter has been tested and complies with FCC and IC rules. Changes or modifications not expressly approved by the party responsible for compliance could void the user's authority to operate the device.

This equipment complies with FCC radiation exposure limits set forth for an uncontrolled environment. End users must follow the specific operating instructions for satisfying RF exposure compliance. This transmitter must be at least 20cm from the user and must not be co-located or operating in conjunction with any other antenna or transmitter.

**FCC and ISED Notes: Long Range Radar - Automotive Distance Control Systems GmbH**

FCC ID: OAYARS5B

IC: 4135A-ARS5B

Canada only:



---

This device complies with Industry Canada license-exempt RSS standard(s). Operation is subject to the following two conditions:

1. This device may not cause harmful interference, and
2. This device must accept any interference received, including interference that may cause undesired operation.

Le présent appareil est conforme aux CNR d'Industrie Canada applicables aux appareils radio exempts de licence. L'exploitation est autorisée aux deux conditions suivantes:

1. l'appareil ne doit pas produire de brouillage, et
2. l'utilisateur de l'appareil doit accepter tout brouillage radioélectrique subi, même si le brouillage est susceptible d'en compromettre le fonctionnement.

Canada & US:

Radiofrequency radiation exposure Information: This equipment complies with FCC and IC radiation exposure limits set forth for an uncontrolled environment. This equipment should be installed and operated with a minimum distance of 20 cm between the radiator and your body.

This transmitter must not be co-located or operating in conjunction with any other antenna or transmitter.

Cet équipement est conforme aux limites d'exposition aux rayonnements IC établies pour un environnement non contrôlé. Cet équipement doit être installé et utilisé avec un minimum de 20 cm de distance entre la source de rayonnement et votre corps.

US: FCC Notice

Changes or modifications not expressly approved by the party responsible for compliance could void the user's authority to operate the equipment.

**FCC and ISED Notes: Short Range Radar Model: SRR5-B - Automotive Distance Control Systems GmbH**

FCC ID: OAYSRR5B

IC: 4135-SRR5B

Radiofrequency radiation exposure Information:

This equipment complies with FCC radiation exposure limits set forth for an uncontrolled environment. This equipment should be installed and operated with a minimum distance of 20 cm between the radiator and your body.

This transmitter must not be co-located or operating in conjunction with any other antenna or transmitter.

FCC Notice

Changes or modifications not expressly approved by the party responsible for compliance could void the user's authority to operate the equipment.

**FCC and ISED Note: Bluetooth Vehicle Key, ACM Node BTLE/LF, ACM Node BTLE/LF/NFC - Pektron Group**

FCC ID: AQO013, AQO012, AQO011

IC: 10176A-013, 10176A-012, 10176A-011

US

This device complies with Part 15 of the FCC Rules.

Operation is subject to the following two conditions:

1. This device may not cause harmful interference.
2. This device must accept any interference received, including interference that may cause undesired operation.

This equipment complies with FCC radiation exposure limits set forth for an uncontrolled environment. End-users must follow the specific operating instructions for satisfying RF exposure compliance. This transmitter must not be co-located or operating in conjunction with any other antenna or transmitter.

Changes or modifications not expressly approved by the party responsible for compliance could void the user's authority to operate the equipment.

**FCC and ISED Notes: Telematics Control Unit– Lucid USA, Inc.**

FCC ID: 2AXZJ-CTX0700, 2AXZJ-CTX0710

IC: 27970-CTX0700,27970-CTX0710

**FCC Interference Statement**

This equipment has been tested and found to comply with limits for a Class B digital device, pursuant to Part 15 of the FCC rules. These limits are designed to provide reasonable protection against harmful interference in a residential installation. This equipment generates, uses, and can radiate radio frequency energy and, if not installed and used in accordance with the instructions, may cause harmful interference to radio communications. However, there is no guarantee that interference will not occur in a particular installation. If this equipment does cause harmful interference to radio or television reception, which can be determined by turning the equipment off and on, the user is encouraged to try and correct the interference by one or more of the following measures:

- Reorient or relocate the receiving antenna.
- Increase the separation between the equipment and receiver.
- Connect the equipment into an outlet on a circuit different from that which the receiver is connected.
- Consult the dealer or an experienced radio/TV technician for help.

FCC Caution: Any changes or modifications not expressly approved by the party responsible for compliance could void the user's authority to operate this equipment.

This device complies with Part 15 of the FCC Rules. Operation is subject to the following two conditions:

1. This device may not cause harmful interference, and
2. This device must accept any interference received, including interference that may cause undesired operation.

---

This device and its antenna(s) must not be co-located or operating in conjunction with any other antenna or transmitter.

For products available in the USA/Canada market, only channel 1-11 can be operated. Selection of other channels is not possible.

**IMPORTANT NOTE:**

**FCC Radiation Exposure Statement:**

This equipment complies with FCC radiation exposure limits set forth for an uncontrolled environment. This equipment should be installed and operated with a minimum distance of 25cm between the radiator & your body.

**FCC and ISED Notes: Center Console Controller – Lucid USA, Inc**

FCC ID: 2AXZJ-K2B000

IC: 27970-K2B000

**FCC Interference Statement**

This device complies with part 15 of the FCC Rules. Operation is subject to the following two conditions:

1. This device may not cause harmful interference.
2. This device must accept any interference received, including interference that may cause undesired operation.

Changes or modifications made to this equipment not expressly approved by Lucid Motors, Inc. may void the FCC authorization to operate this equipment.

**FCC Radiation Exposure Statement**

This equipment complies with FCC radiation exposure limits set forth for an uncontrolled environment. This equipment should be installed and operated with a minimum distance of 25cm between the radiator and your body.

**IC Antenna Statement**

Under Industry Canada regulations, this radio transmitter may only operate using an antenna of a type and maximum (or lesser) gain approved for the transmitter by Industry Canada. To reduce potential radio interference to other users, the antenna type and its gain should be so chosen that the equivalent isotropically radiated power (e.i.r.p.) is not more than that necessary for successful communication.

Conformément à la réglementation d'Industrie Canada, le présent émetteur radio peut

fonctionner avec une antenne d'un type et d'un gain maximal (ou inférieur) approuvé pour

l'émetteur par Industrie Canada. Dans le but de réduire les risques de brouillage radioélectrique à l'intention des autres utilisateurs, il faut choisir le type d'antenne et son gain de sorte que la puissance isotrope rayonnée équivalente (p.i.r.e.) ne dépasse pas l'intensité nécessaire à l'établissement d'une communication satisfaisante.

**IC Licence exempt**

This device complies with Industry Canada licence-exempt RSS standard(s). Operation is subject to the following two conditions:

- (1) this device may not cause interference, and
- (2) this device must accept any interference, including interference that may cause undesired operation of the device.

Le présent appareil est conforme aux CNR d'Industrie Canada applicables aux appareils radio exempts de licence. L'exploitation est autorisée aux deux conditions suivantes :

- (1) l'appareil ne doit pas produire de brouillage, et
- (2) l'utilisateur de l'appareil doit accepter tout brouillage radioélectrique subi, même si le brouillage est susceptible d'en compromettre le fonctionnement.

#### IC Radiation Exposure Statement

This equipment complies with ISED radiation exposure limits set forth for an uncontrolled environment. This equipment should be installed and operated with greater than 25cm between the radiator & your body.

Cet équipement est conforme aux limites d'exposition aux rayonnements ISED établies pour un environnement non contrôlé. Cet équipement doit être installé et utilisé à plus de 25cm entre le radiateur et votre corps.

#### Event Data Recorder

This vehicle is equipped with an event data recorder (EDR). The main purpose of an EDR is to record, in certain crash or near crash-like situations, such as an airbag deployment or hitting a road obstacle, data that will assist in understanding how a vehicle's systems performed. The EDR is designed to record data related to vehicle dynamics and safety systems for a short period of time, typically 30 seconds or less. The EDR in this vehicle is designed to record such data as:

- How various systems in your vehicle were operating;
- Whether or not the driver and passenger safety belts were buckled/fastened;
- How far (if at all) the driver was depressing the accelerator and/or brake pedal; and,
- How fast the vehicle was traveling.

These data can help provide a better understanding of the circumstances in which crashes and injuries occur.

*Note:* EDR data are recorded by your vehicle only if a non-trivial crash situation occurs; no data are recorded by the EDR under normal driving conditions, and no personal data (e.g., name, gender, age, and crash location) are recorded. However, other parties, such as law enforcement, could combine the EDR data with the type of personally identifying data routinely acquired during a crash investigation.

To read data recorded by an EDR, special equipment is required, and access to the vehicle or the EDR is needed. In addition to the vehicle manufacturer, other parties, such as law enforcement, that have the special equipment, can read the information if they have access to the vehicle or the EDR.

---

### **Food and Drug Administration (FDA) Compliance Information**

- **WARNING:** DO NOT attempt to remove, access, or modify the LiDAR unit in this vehicle. The LiDAR unit is a Class I laser device subject to regulation by the FDA. There are NO permitted service or maintenance procedures for your vehicle's LiDAR. If you suspect that the LiDAR unit is not functioning properly, contact Lucid immediately for instructions.

### **Vehicle Patents**

A list of Lucid Air patents can be found at [www.lucidmotors.com/legal](http://www.lucidmotors.com/legal).

# Index

## A

- Accessory mode [65](#)
- Adaptive Cruise Control [97](#)
- Air filter replacement [161](#)
- Airbags [46](#)
  - Obstruction of [49](#)
  - Warning indicator [53](#)
- Alerts and notifications [55](#)
- Anti-Lock Braking System (ABS) [78](#)
- Anti-theft system [28](#)
- Audio
  - Physical controls [123](#)
  - Playing from devices [126](#)
  - Settings [127](#)
- Automatic parking
  - Automatic Park In [111](#)
  - Automatic Park Out [112](#)
  - Distance warning [115](#)

## B

- Batteries (12V)
  - Specifications [194](#)
- Battery (high-voltage) [147](#)
  - Charging [148](#)
  - Emergency disabling [200](#)
  - Health [147](#)
  - Specifications [194](#)
  - Temperature limits [147](#)
- Battery (key fob) [18](#)
- Blind Spot Display [109](#)
- Blind Spot Monitoring [109](#)
- Bluetooth®
  - Pairing [134](#)
  - Playing media [126](#)
  - Using a paired phone [135](#)
- Body repairs [167](#)
- Brake fluid [157](#)
- Brakes
  - Anti-Lock Braking System (ABS) [78](#)
  - Brake pad wear [81](#)
  - Emergency braking [105](#)
  - Lucid Stability Control [82](#)
  - Regenerative braking [79](#)
  - Specifications [191](#)
  - Stopping Mode [80](#)

## C

- Cameras
  - Limitations [92](#)
  - Rear view [115](#)
  - Surround view [114](#)
- Car cover [164](#)
- Car washes [163](#)

- Cargo area
  - Folding the rear seat [33](#)
  - Front [25](#)
  - Pass-through hatch [33](#)
  - Rear [27](#)
- Charge port [148](#)
  - Light [150](#)
  - Manually open [149](#)
- Charging
  - Instructions [149](#)
  - Safety checklist [148](#)
  - Set charge limit [150](#)
  - Status [150](#)
  - Temperature limits [151](#)
- Charging cable
  - Emergency manual release [150](#)
- Child restraints
  - Automatic Locking Retractor (ALR) [37](#)
- Child safety locks [21](#)
- Child safety seats
  - Booster seats [42](#)
  - Choosing a seat [41](#)
  - Guidelines [41](#)
  - Installation [42](#)
- Cleaning
  - Carpets and floor mats [165](#)
  - Displays [164](#)
  - Exterior [162](#)
  - Interior [164](#)
  - Underbody [163](#)
  - Wheels [163](#)
  - Windshield, windows, and mirrors [163](#)
  - Wiper blades [163](#)
- Collision protection [105](#)
- Collision repairs [167](#)
- Collision warning [106, 107](#)
- Contact information
  - Lucid Motors [211](#)
  - Lucid Roadside Assistance [196](#)
  - NHTSA [212](#)
  - Transport Canada [212](#)
- Cross Traffic Protection [107](#)
- Cruise control [97](#)
- Cut loop [200](#)

## D

- Data
  - Event recording [213](#)
  - Personal [4](#)
  - Service recording [213](#)
- Delivery mileage [4](#)
- Displays
  - Cleaning [164](#)
  - Glass Cockpit [12](#)
  - Pilot Panel [13, 14](#)
  - Smart drawer [13](#)

Distracted Driver Alert [102](#)  
Doors  
    Automatic locking and unlocking [21](#)  
    Child safety locks [21](#)  
    Opening and closing [20](#)  
    Opening with no power [21](#)  
Download  
    Owner's Manual [141](#)  
    Software updates [142](#)  
DreamDrive  
    Limitations [92](#)  
    Requirements [97](#)  
    Steering wheel controls [96](#)  
Drive Mode [65](#)  
Drowsy Driver Alert [102](#)

## E

Emergency braking [105](#)  
Event data recording [213](#)

## F

Firefighting [201](#)  
Flatbed transporting [198](#)  
Floor mats [166](#)  
    Cleaning [165](#)  
Forward Collision Warning [106](#)  
Front passenger detection [50](#)  
Front suspension specifications [192](#)

## H

Hauling your vehicle [198](#)  
Head restraints  
    Adjusting [35](#)  
    Positioning [35](#)  
    Reinstalling [36](#)  
    Removing [36](#)  
High Beam Assist [103](#)  
Highway Assist [99](#)  
HomeLink® [138](#)  
Hood [24](#)  
    Interior emergency release [25](#)

## I

Indicator lights  
    Airbag [53](#)  
    Automatic Emergency Braking [105](#)  
    Low tire pressure [181](#)  
Intrusion Alert [28](#)

## K

Key fob  
    Battery replacement [18](#)

Key fob (continued)  
    Care instructions [19](#)  
    Low battery indicator [18](#)  
    Replacement [19](#)  
    Troubleshooting [17](#)  
    Using [16](#)

## L

Label  
    Cut loop [200](#)  
    Tire and loading information [174](#)  
    Vehicle certification [10](#)  
Lane Departure Protection [108](#)  
Load carrying [183](#)  
Locking your vehicle [16](#)

## M

Maintenance  
    Brake fluid [157](#)  
    Daily and monthly checks [153](#)  
    Service intervals [155](#)  
    Underbody [163](#)  
    Washer fluid [158](#)  
    Wiper blades [159](#)

Maps [129](#)  
    Offline mode [133](#)  
    Orientation [131](#)

Media  
    Apps [126](#)  
    Physical controls [123](#)  
    Playing from devices [126](#)  
    Radio [125](#)

Mirrors  
    Blind Spot Display [109](#)  
    Blind Spot Monitoring [109](#)  
Mobile Key [16](#)

## N

Navigation [129](#)  
    Offline mode [133](#)  
Near-Field Communication (NFC) card [17](#)

## P

Parking  
    Automatic Park In [111](#)  
    Automatic Park Out [112](#)  
    Distance warning [115](#)  
Phone app [135](#)

## R

Radio [125](#)  
Rear Pedestrian Collision Detection [107](#)

- Rear suspension specifications 193
- Rear view camera 115
- Regenerative braking 79
- Reporting safety defects 212
- Rescue operations
  - Firefighting 201

## S

- Safety instructions
  - Electrical/high voltage safety 154
  - Obstruction of air bags 49
- Seat belts
  - Fastening and releasing 38
  - In a collision 39
  - Reminders 38
  - Testing 40
  - Wearing correctly 37
  - Wearing when pregnant 39
- Seats
  - Adjustment 30
  - Folding (rear) 33
  - Heating (rear) 33
  - Heating and ventilation 31
  - Massage 31
  - Pass-through hatch 33
- Service
  - Data recording 213
- Side airbags 48
- Specifications
  - 12V battery 194
  - Brakes 191
  - Front suspension 192
  - High-voltage battery 194
  - Rear suspension 193
  - Steering 190
  - Tire pressures 189
  - Tires 188
  - Wheels 188
- Steering specifications 190
- Steering wheel
  - Media controls 123
- Sunshades 22

## T

- Tire and loading information label 174
- Tire care 176
- Tire Identification Number (TIN) 171
- Tire pressure checking 177
- Tire Pressure Monitoring System
  - Malfunction 181
  - Operation 181
- Tires 170
  - Asymmetric 179
  - Chains 180
  - Degradation 177
  - Flat spots 178
  - Grading 173

- Tires (continued)
  - Markings 170
  - Pressure label 174
  - Pressure monitoring 181
  - Pressures 177
  - Quality 173
  - Replacement of 179
  - Rotation 176
  - Run-flat 179
  - Socks 180
  - Specifications 188
  - Wear 176
  - Wheel alignment 176
  - Winter 180
- TPMS 181
- Traction control 82
- Traffic Drive-Off Alert 102
- Traffic Sign Recognition 101
- Trailer towing 183
- Trip information 55
- Trunk 26
  - Interior emergency release 27

## U

- Uniform tire quality grading 173
- Unlocking your vehicle 16
- User Profile
  - Creating 118
  - Loading preferences 120
  - Managing 120
  - Settings 119
  - Types 118
- Using 16

## V

- Vehicle
  - Accessories and modifications 167
  - Certification label 10
  - Modifications 4
- Vehicle Identification Number (VIN) 10
- Vehicle lashing 198
- Vehicle loading 183
  - Determining correct load limit 183
  - Example load calculations 184
- Vehicle weights 187

## W

- Washers
  - Checking fluid level 158
  - Cleaning washer jets 159
- Wheels
  - Replacement 179
  - Specifications 188
- Wi-Fi 137
- Window lock 22
- Windows



Windows (continued)

Cleaning [163](#)

Opening and closing [22](#)

Sunshades [22](#)